

29

- EN** Gynecology
- DE** Gynäkologie
- ES** Ginecología
- FR** Gynécologie
- IT** Ginecologia

Page 682 to 722





CUSCO

- BI 29-8001-01 75 x 17mm
- BI 29-8001-02 75 x 32mm
- BI 29-8001-03 85 x 35mm
- BI 29-8001-04 100 x 37mm

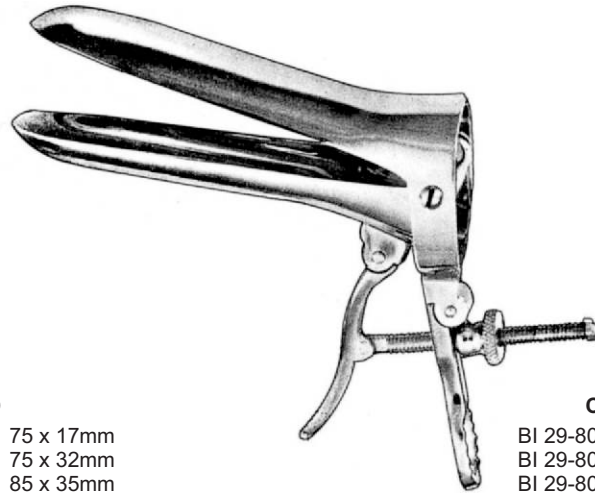

CUSCO

- BI 29-8002-01 75 x 17mm
- BI 29-8002-02 75 x 32mm
- BI 29-8002-03 80 x 32mm
- BI 29-8002-04 85 x 35mm
- BI 29-8002-05 110 x 35mm
- BI 29-8002-06 115 x 37mm



CUSCO

- BI 29-8003-01 75 x 32mm
- BI 29-8003-02 85 x 35mm
- BI 29-8003-03 100 x 35mm
- BI 29-8003-04 85 x 35mm (with cold light carrier)
- BI 29-8003-05 (cold light carrier only)



CUSCO

- BI 29-8004-01 75 x 17mm
- BI 29-8004-02 85 x 17mm
- BI 29-8004-03 100 x 17mm



CUSCO (Swiss pattern)

- BI 29-8005-01 80 x 22mm
- BI 29-8005-02 100 x 25mm
- BI 29-8005-03 105 x 27mm
- BI 29-8005-04 115 x 27mm



CUSCO'S

- BI 29-8006-01 (LL)
- BI 29-8006-02 (L)
- BI 29-8006-03 (M)
- BI 29-8006-04 (S)
- BI 29-8006-05 (SS)
- BI 29-8006-06 (SSS)



for children

COLLIN
 BI 29-8007-01 55 x 10mm



COLLIN
 BI 29-8007-02 65 x 20mm

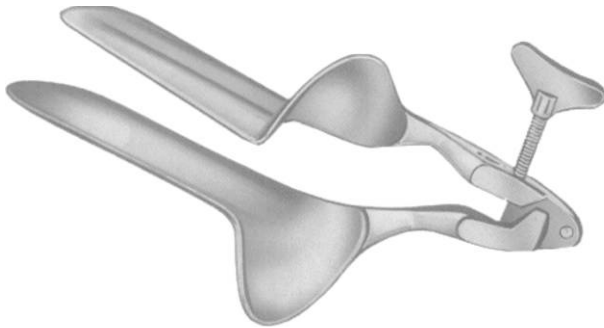

Collin-Landau
 Medium BI 29-8007-03 35 x 100 mm



Collin

Blall	BI 29-8007-12	30 x 85 mm
Medium	BI 29-8007-13	35 x 100 mm
Large	BI 29-8007-14	40 x 110 mm

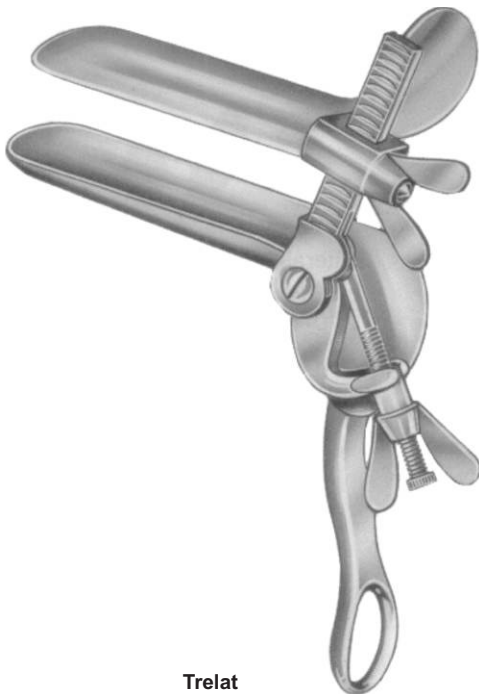

Trelat

	a	b
	mm	mm
BI 29-8008-01	85	33
BI 29-8008-02	95	35
BI 29-8008-03	115	43

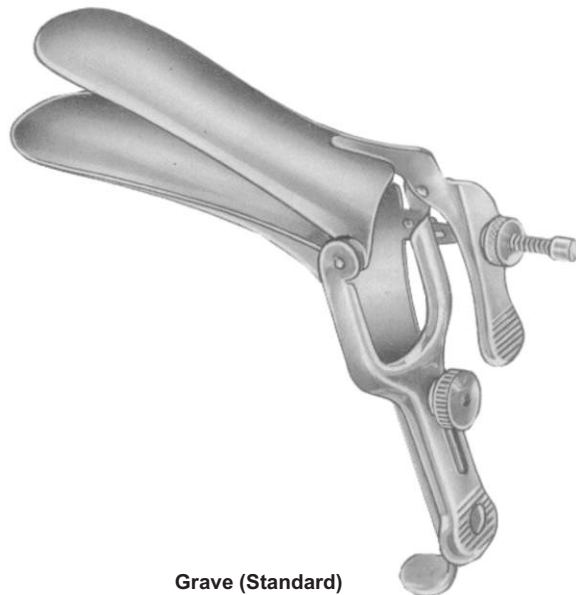

Grave (Standard)

	a	b
	mm	mm
BI 29-8009-01	75	20
BI 29-8009-02	95	35
BI 29-8009-03	115	35
BI 29-8009-04	125	35





Black

Grave	a mm	b mm
BI 29-8010-01	75	20
BI 29-8010-02	95	35
BI 29-8010-03	115	35
BI 29-8010-04	130	25



Grave	a mm	b mm
Angled 135°		
BI 29-8011-00	101	35



Fergusson	
BI 29-8011-01	25mm Ø
BI 29-8011-02	30mm Ø
BI 29-8011-03	35mm Ø
BI 29-8011-04	40mm Ø

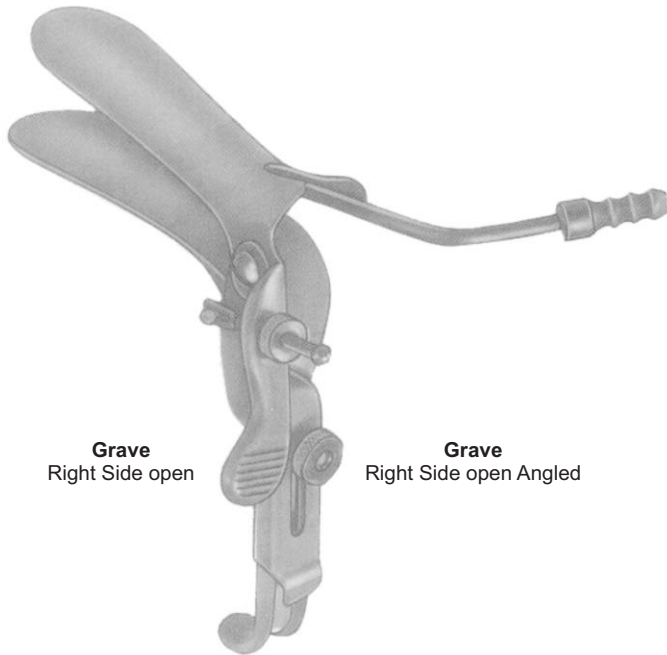

Grave
Right Side open

Grave
Right Side open Angled

	a mm	b mm
BI 29-8012-01	101	35
BI 29-8012-02		

Lateral Specula

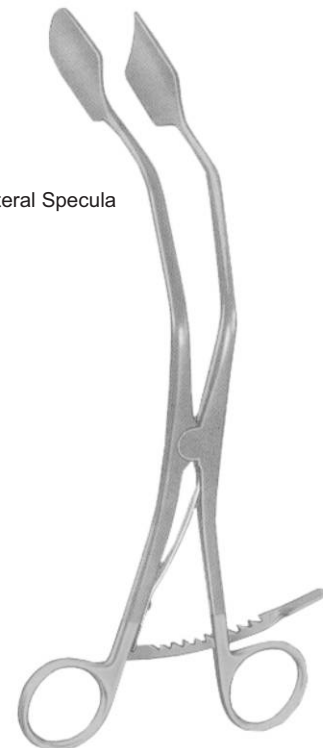

BI 29-8013-00



Pederson

	a	b
	mm	mm
BI 29-8014-01	75	13
BI 29-8014-02	100	22
BI 29-8014-03	120	25
BI 29-8014-04	130	25

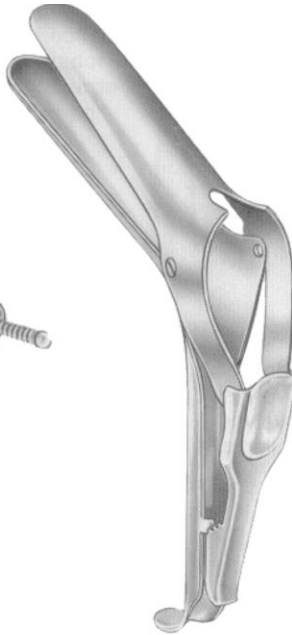

Semm

	a	b
	mm	mm
BI 29-8015-01	90	14/18
BI 29-8015-02	100	17/20
BI 29-8015-03	100	25/30

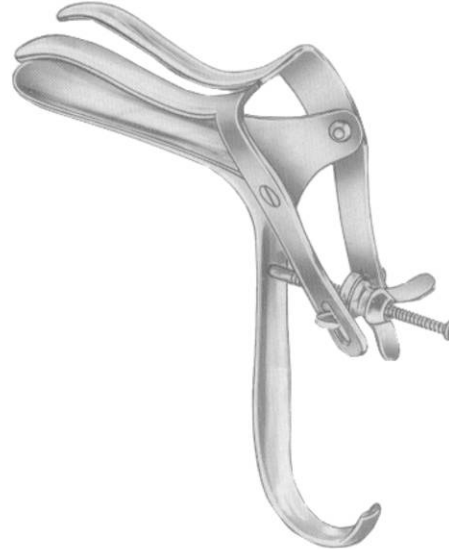

Nott

	a	b
	mm	mm
BI 29-8016-01	90	30
BI 29-8016-02	110	30

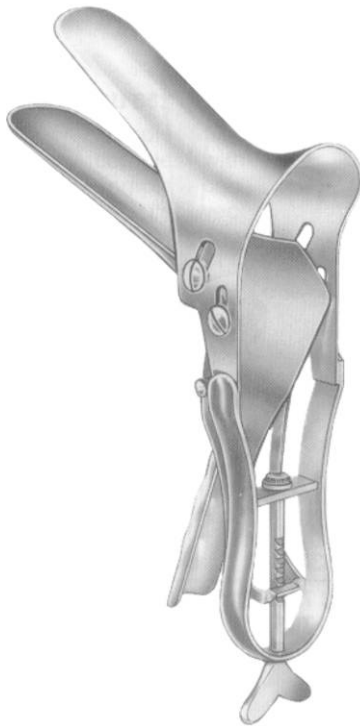

Seyffert

	a	b
	mm	mm
BI 29-8017-01	100	17
BI 29-8017-02	110	33

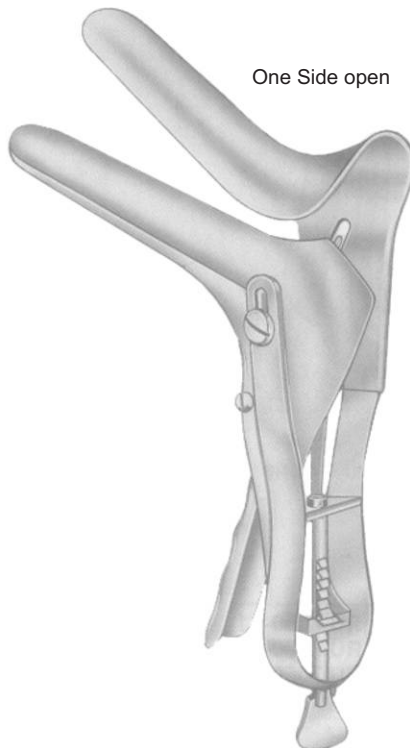

One Side open

Seyffert

	a	b
	mm	mm
BI 29-8018-00	110	33



SAKURAI'S

BI 29-8018-01	(LL)
BI 29-8018-02	(L)
BI 29-8018-03	(M)
BI 29-8018-04	(S)





Sims (single ended)
BI 29-8019-01 63 x 32 mm
BI 29-8019-02 76 x 32 mm
BI 29-8019-03 89 x 38 mm

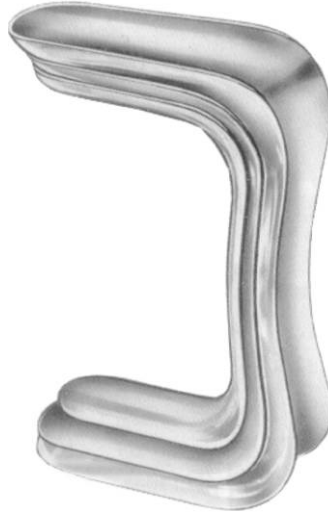

Sims (double ended)
BI 29-8020-01 65 x 25 mm (70 x 30 mm)
BI 29-8020-02 70 x 35 mm (70 x 35 mm)
BI 29-8020-03 85 x 35 mm (90 x 40 mm)
BI 29-8020-04 100 x 35 mm x 40 mm
BI 29-8020-05 120 x 35 mm x 40 mm

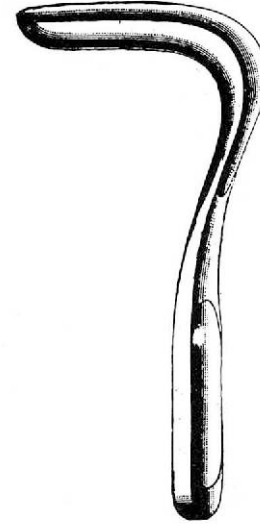

SIMS
BI 29-8020-11 60 x 25mm
BI 29-8020-12 70 x 30mm
BI 29-8020-13 80 x 35mm



Jackson

Fig.	a mm	b mm
BI 29-8021-01	1	75 X 35
BI 29-8021-02	2	90 X 35
BI 29-8021-03	3	100 X 35
BI 29-8021-04	4	75 X 40
BI 29-8021-05	5	90 x 40
BI 29-8021-06	6	100 x 40



Eastman

Fig.	a mm	b mm
BI 29-8022-01	1	75 X 35
BI 29-8022-02	2	90 X 35
BI 29-8022-03	3	100 X 35
BI 29-8022-04	4	75 X 40
BI 29-8022-05	5	90 x 40
BI 29-8022-06	6	100 x 40

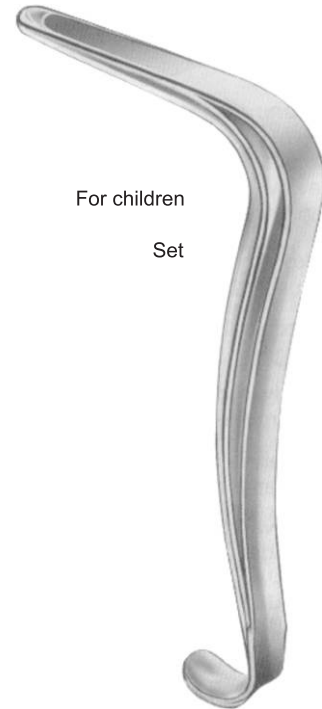

For children
Set

Kristeller
BI 29-8023-00
70x15 mm

Specula

Set of 1 specula and 1 retractor

- Fig. 1 BI 29-8024-00
- Fig. 2 BI 29-8025-00
- Fig. 3 BI 29-8026-00

Specula

	Fig.	a mm	b mm
BI 29-8027-01	1	70	27
BI 29-8028-01	2	75	30
BI 29-8029-01	3	90	36

Retractors

	Fig.	a mm	b mm
BI 29-8030-02	1	75	23
BI 29-8031-02	2	80	26
BI 29-8032-02	3	95	32



**Kristeller
 (Standard)**

With conically shaped blades for virgins

Set of 1 specula and 1 retractor

- Fig. 00 BI 29-8033-00
- Fig. 0 BI 29-8034-00

Specula

	Fig.	a mm	b mm
BI 29-8035-01	00	110	18
BI 29-8036-01	0	110	21

Retractors

	Fig.	a mm	b mm
BI 29-8037-02	00	115	14
BI 29-8038-02	0	115	17

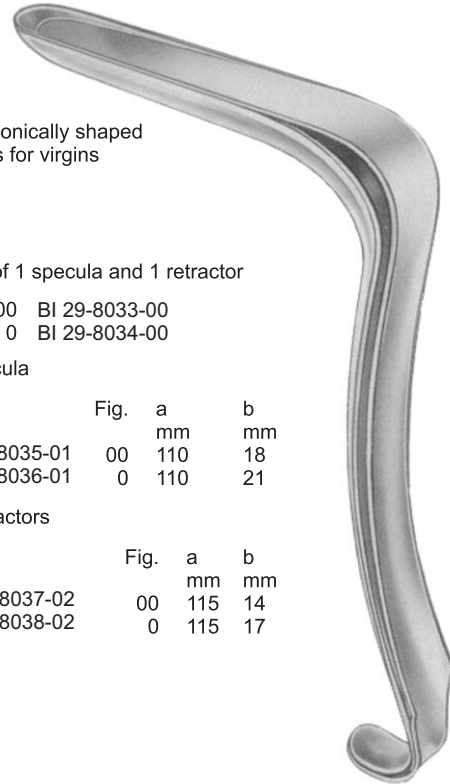

Kristeller

With extra long blades

Set of 1 specula and 1 retractor

- Fig. 1 BI 29-8039-00
- Fig. 2 BI 29-8040-00
- Fig. 3 BI 29-8041-00

Specula

	Fig.	a mm	b mm
BI 29-8042-01	1	110	27
BI 29-8043-01	2	110	30
BI 29-8044-01	3	110	36

Retractors

	Fig.	a mm	b mm
BI 29-8045-02	1	115	23
BI 29-8046-02	2	115	26
BI 29-8047-02	3	115	32

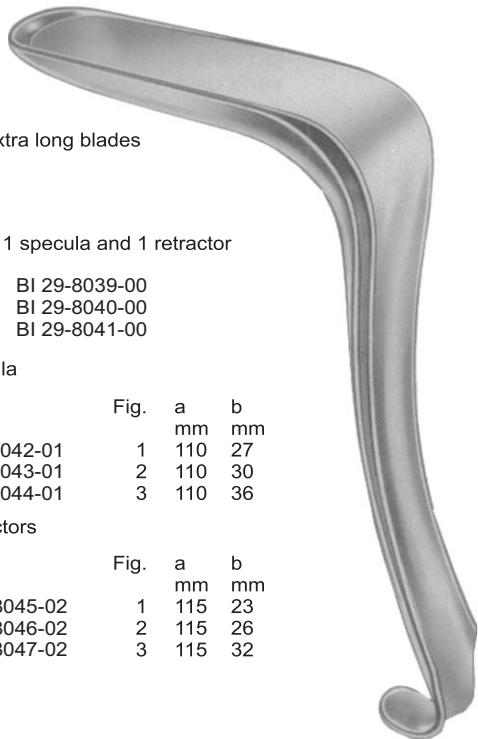

**Kristeller
 (Standard)**

With flat hollow specula



Set of 1 specula and 1 retractor

- Fig. 1 BI 29-8048-00
- Fig. 2 BI 29-8049-00
- Fig. 3 BI 29-8050-00

Specula

	Fig.	a mm	b mm
BI 29-8051-01	1	105	26
BI 29-8052-01	2	105	28
BI 29-8053-01	3	105	33

Retractors

	Fig.	a mm	b mm
BI 29-8054-02	1	115	22
BI 29-8055-02	2	115	24
BI 29-8056-02	3	115	29

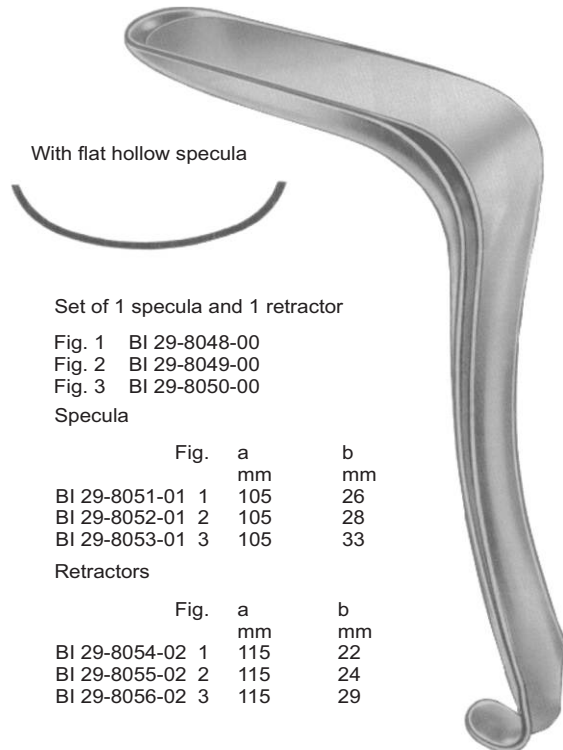

Kristeller



	a	b
	mm	mm
BI 29-8057-20	100	20
BI 29-8057-25	100	25
BI 29-8057-30	100	30
BI 29-8057-35	100	35
BI 29-8057-40	100	40
BI 29-8058-20	130	20
BI 29-8058-25	130	25
BI 29-8058-30	130	30
BI 29-8058-35	130	35
BI 29-8058-40	130	40

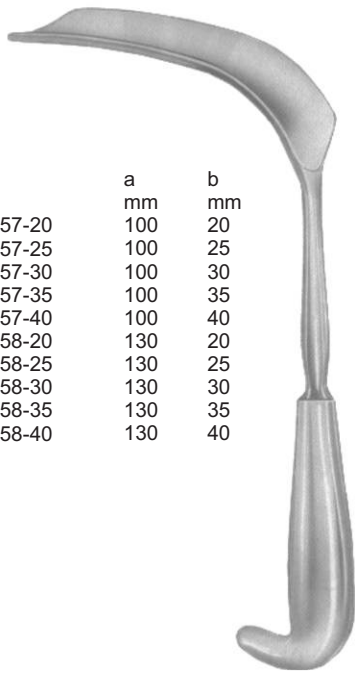

Matzenauer



Braun
BI 29-8059-18
18 cm/7"
56x13 mm



Braun
BI 29-8060-18
18 cm/7"
60x10 mm



Ulrich
BI 29-8061-19
19.5 cm/7 1/2"
80x20 mm



BI 29-8062-19
19 cm/7 1/2"
85x17 mm

Set

BI 29-8063-00	Fig. 1
BI 29-8064-00	Fig. 2

Specula

	Fig.	a	b
		mm	mm
BI 29-8065-01	1	70	40
BI 29-8066-01	2	90	40

Retractors

	Fig.	a	b
		mm	mm
BI 29-8067-02	1	70	33
BI 29-8068-02	2	90	33

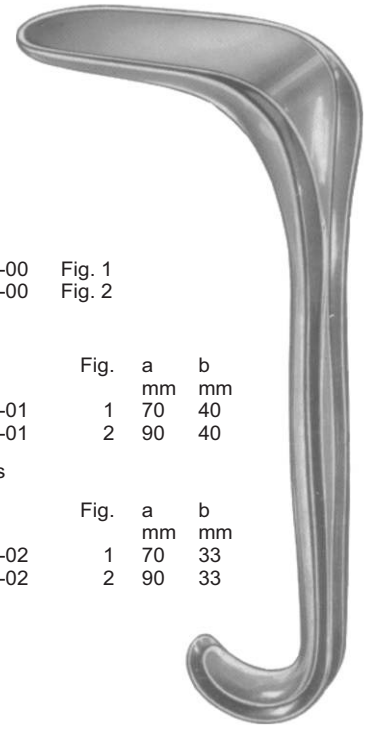

Kallmorgen

GYNECOLOGY



Specula			
BI	Fig. Set	a mm	b mm
29-8069-00	00	100	13/23
29-8069-01	01	100	16/30
29-8069-02	02	100	16/30

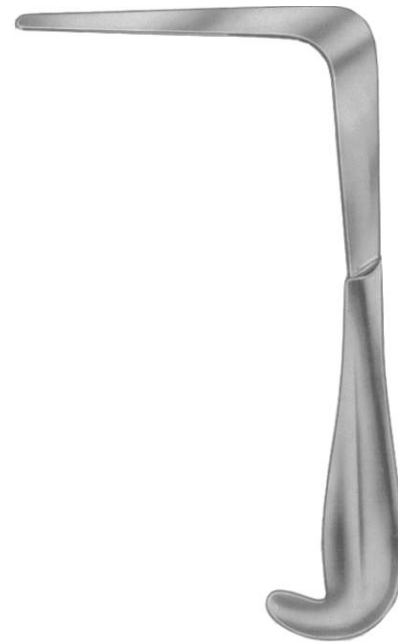

Retractors			
BI	Fig. Set	a mm	b mm
29-8070-00	00	100	11/21
29-8070-01	01	100	14/27
29-8070-02	02	100	14/27

Mathieu

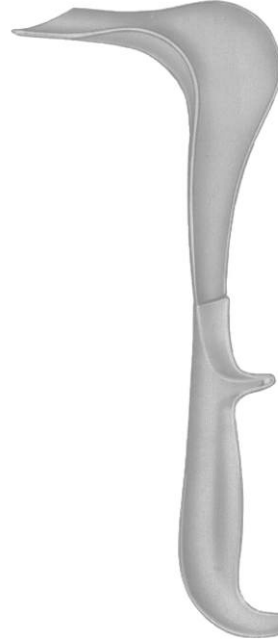

Fig.		
BI	a mm	b mm
29-8071-01	75	45
29-8071-02	90	45
29-8071-03	110	45

Mathieu



29-8072-01	75 x 280mm
29-8072-02	90 x 280mm
29-8072-03	100 x 280mm
29-8072-04	115 x 280mm

Doyen

Hollow handle 28cm/11"

extra large pattern



BI 29-8073-14
140 x 30mm



BI 29-8074-13
135 x 36mm



BI 29-8074-14
140 x 36mm



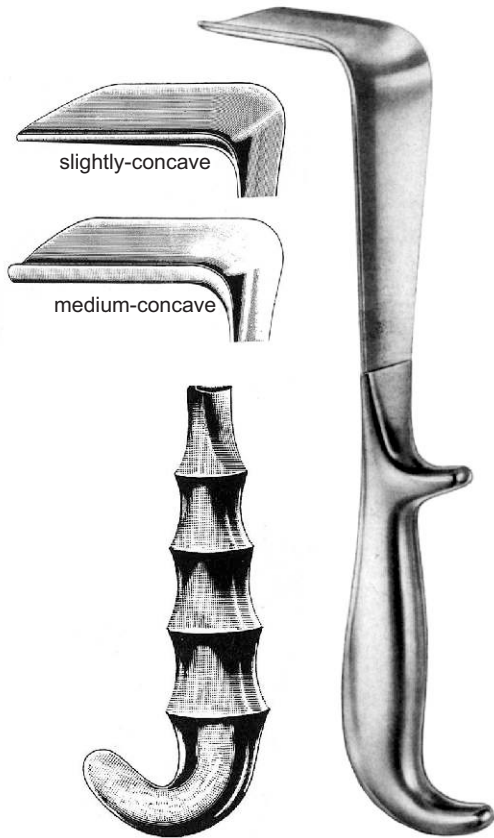
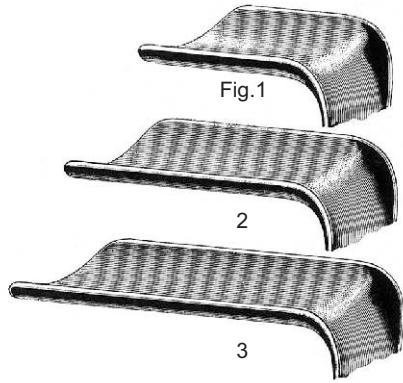
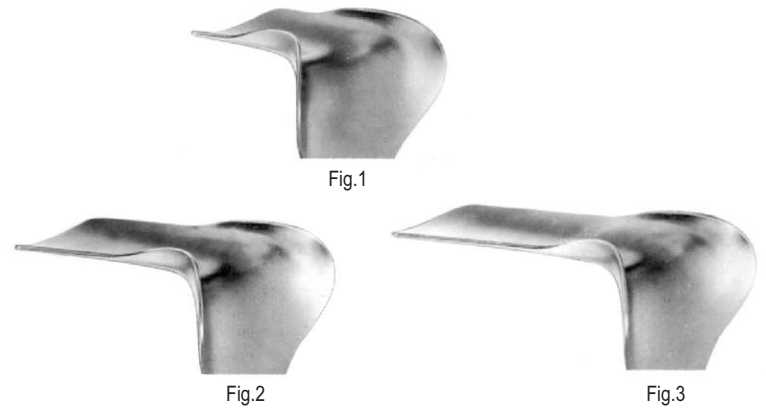

Fig	DOYEN FG		DOYEN		
	mm	mm	slightly-concave	slightly-concave	medium-concave
1	55	35	BI 29-8075-11	BI 29-8075-01	BI 29-8078-01
2	85	35	BI 29-8075-12	BI 29-8075-02	BI 29-8078-02
3	115	35	BI 29-8075-13	BI 29-8075-03	BI 29-8078-03
1	55	45	BI 29-8076-11	BI 29-8076-01	BI 29-8079-01
2	85	45	BI 29-8076-12	BI 29-8076-02	BI 29-8079-02
3	115	45	BI 29-8076-13	BI 29-8076-03	BI 29-8079-03
1	55	60	BI 29-8077-11	BI 29-8077-01	BI 29-8080-01
2	85	60	BI 29-8077-12	BI 29-8077-02	BI 29-8080-02
3	115	60	BI 29-8077-13	BI 29-8077-03	BI 29-8080-03



DOYEN
 BI 29-8080-11 75 x 45mm
 BI 29-8080-12 90 x 45mm
 BI 29-8080-13 110 x 45mm

Doyen
 25 cm/10"

	a	b
	mm	mm
BI 29-8081-01	60	30
BI 29-8081-02	70	30
BI 29-8081-03	80	30

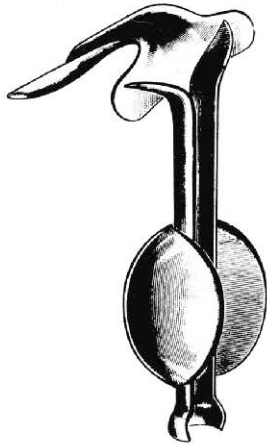

AUVARD
 BI 29-8082-01 80 x 38mm 2 lbs
 BI 29-8082-02 80 x 38mm 2.5 lbs
 BI 29-8082-03 80 x 38mm 3 lbs

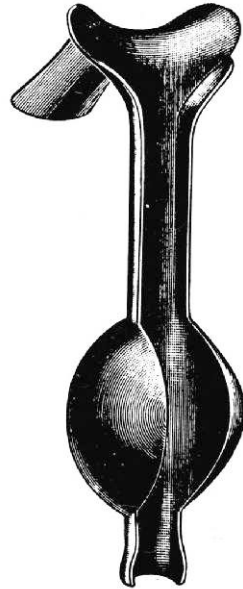

AUVARD
 BI 29-8082-00
 68 x 40mm 3 lbs



80 x 38 mm

AUVARD
 BI 29-8082-04 2.5 lbs
 BI 29-8082-05 3 lbs

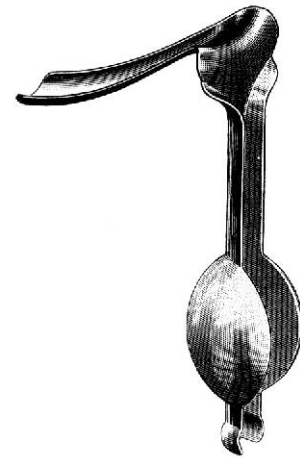

Steiner-Auvard
 BI 29-8083-01 140 x 35mm 2.5 lbs
 BI 29-8083-02 140 x 35mm 2.5 lbs
 laser pattern

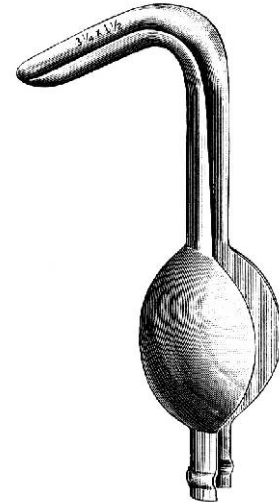

Henrotin
 BI 29-8083-03 80 x 35mm 3 lbs
 30° blade angled down



Landau

	a	b
	mm	mm
BI 29-8084-01	105	28
BI 29-8084-02	105	38



95 x 45 cm

Dunkel
 BI 29-8084-22



Breisky

	a	b
	mm	mm
BI 29-8085-20	100	20
BI 29-8085-25	100	25
BI 29-8085-30	100	30
BI 29-8085-35	100	35
BI 29-8085-40	100	40
BI 29-8086-20	130	20
BI 29-8086-25	130	25
BI 29-8086-30	130	30
BI 29-8086-35	130	35
BI 29-8086-40	130	40
BI 29-8087-20	160	20
BI 29-8087-25	160	25
BI 29-8087-30	160	30
BI 29-8087-35	160	35
BI 29-8087-40	160	40
BI 29-8088-20	180	20
BI 29-8088-25	180	25
BI 29-8088-30	180	30
BI 29-8088-35	180	35
BI 29-8088-40	180	40
BI 29-8088-50	155	40

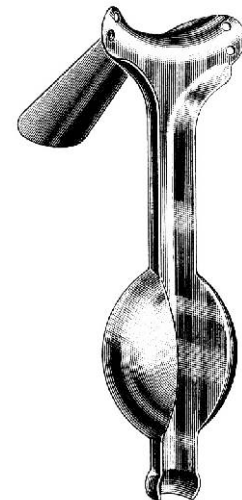

Berlind-Auvard
 BI 29-8083-04
 105 x 40mm 2.5 lbs





A
BI 29-8089-00
handle only



70 x 30mm
BI 29-8089-01



80 x 35mm
BI 29-8089-02



90 x 35mm
BI 29-8089-03



100 x 35mm
BI 29-8089-04

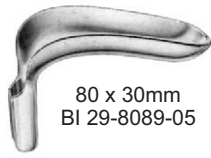

80 x 30mm
BI 29-8089-05



85 x 33mm
BI 29-8089-06



100 x 35mm
BI 29-8089-07



110 x 42mm
BI 29-8089-08



B
BI 29-8089-10
handle only

BOZEMANN

BI 29-8089-20 compl. set with handle A, B and 8 blades
BI 29-8089-30 compl. set with handle A and 8 blades
BI 29-8089-40 compl. set with handle B and 8 blades



Friedman
BI 29-8090-20
10 cm/4"



Comyn Berkeley
Vulva self retaining
BI 29-8090-15
15.5cm/6"

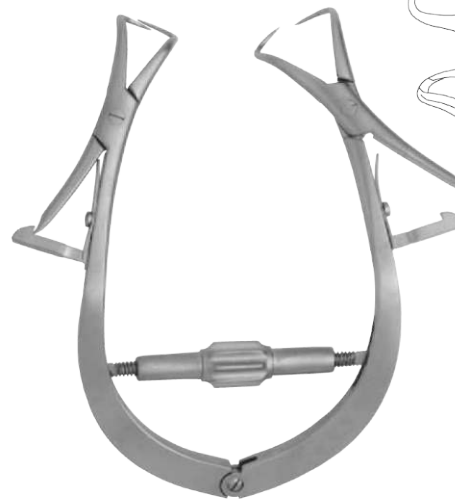

Joll
Thyroid self retaining
BI 29-8091-15
15.5cm/6"

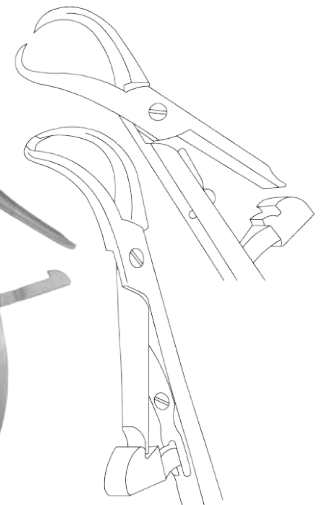

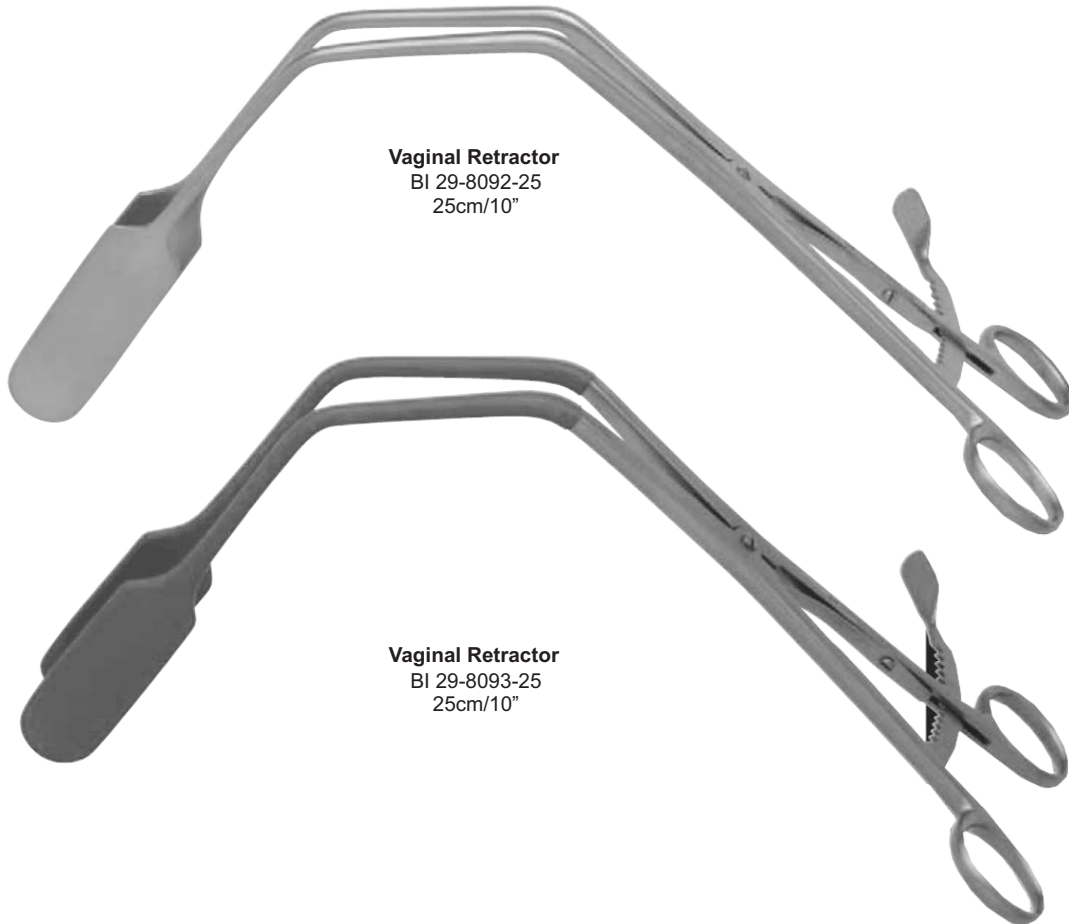
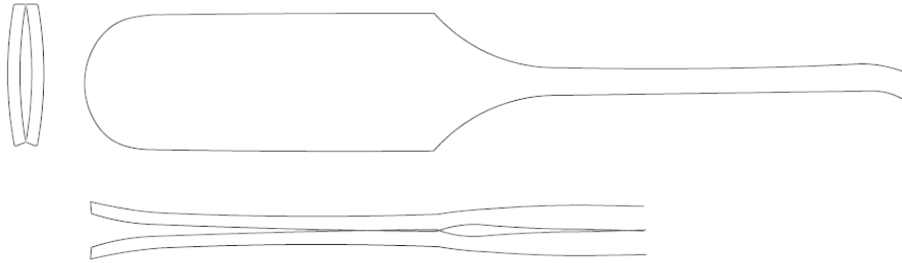

Vaginal Retractor
 BI 29-8092-25
 25cm/10"

Vaginal Retractor
 BI 29-8093-25
 25cm/10"





Scherbak
 BI 29-8094-00 Complete
 BI 29-8094-10 Handle only



BI 29-8094-01
 80x30 mm



BI 29-8094-02
 85x35 mm

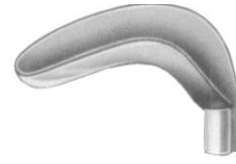

BI 29-8094-03
 90x40 mm



BI 29-8094-04
 55x40/60 mm



BI 29-8094-05
 70x45/70 mm

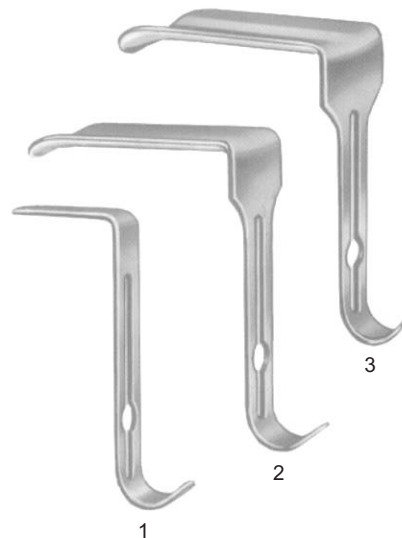
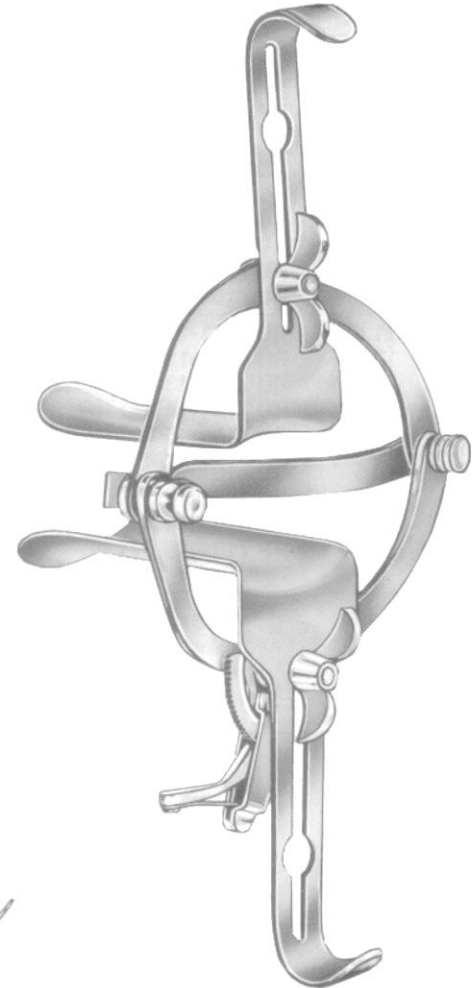

	Fig.	a mm	b mm
BI 29-8095-01	1	45	17
BI 29-8095-02	2	90	37
BI 29-8095-03	3	90	45



O'Sullivan-O'Connor
 BI 29-8095-00
 Complete

GYNECOLOGY



Hegar
 single ended
 18.5 cm long

mm Ø			mm dia.
1.0	BI 29-8096-01	BI 29-8096-51	1.5
2.0	BI 29-8096-02	BI 29-8096-52	2.5
3.0	BI 29-8096-03	BI 29-8096-53	3.5
4.0	BI 29-8096-04	BI 29-8096-54	4.5
5.0	BI 29-8096-05	BI 29-8096-55	5.5
6.0	BI 29-8096-06	BI 29-8096-56	6.5
7.0	BI 29-8096-07	BI 29-8096-57	7.5
8.0	BI 29-8096-08	BI 29-8096-58	8.5
9.0	BI 29-8096-09	BI 29-8096-59	9.5
10.0	BI 29-8096-10	BI 29-8096-60	10.5
11.0	BI 29-8096-11	BI 29-8096-61	11.5
12.0	BI 29-8096-12	BI 29-8096-62	12.5
13.0	BI 29-8096-13	BI 29-8096-63	13.5
14.0	BI 29-8096-14	BI 29-8096-64	14.5
15.0	BI 29-8096-15	BI 29-8096-65	15.5
16.0	BI 29-8096-16	BI 29-8096-66	16.5
17.0	BI 29-8096-17	BI 29-8096-67	17.5
18.0	BI 29-8096-18	BI 29-8096-68	18.5
19.0	BI 29-8096-19	BI 29-8096-69	19.5
20.0	BI 29-8096-20	BI 29-8096-70	20.5
21.0	BI 29-8096-21	BI 29-8096-71	21.5
22.0	BI 29-8096-22	BI 29-8096-72	22.5
23.0	BI 29-8096-23	BI 29-8096-73	23.5
24.0	BI 29-8096-24	BI 29-8096-74	24.5
25.0	BI 29-8096-25	BI 29-8096-75	25.5
26.0	BI 29-8096-26	BI 29-8096-76	26.5
27.0	BI 29-8096-27	BI 29-8096-77	27.5
28.0	BI 29-8096-28	BI 29-8096-78	28.5
29.0	BI 29-8096-29	BI 29-8096-79	29.5
30.0	BI 29-8096-30	BI 29-8096-80	30.5

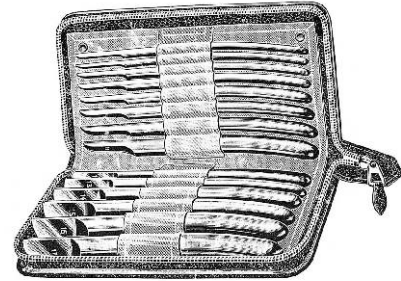

Pieces per set

BI 29-8097-10	14	4 -17 mm
BI 29-8097-20	26	1 - 26 mm
BI 29-8097-30	30	1 - 30 mm

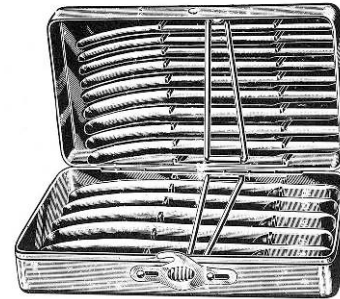

Pieces per set

BI 29-8098-40	14	4 -17 mm
BI 29-8098-50	26	1 - 26 mm
BI 29-8098-60	30	1 - 30 mm



Hegar
 double ended
 20 cm long

Ø mm	
1/2	BI 29-8099-02
3/4	BI 29-8099-04
5/6	BI 29-8099-06
7/8	BI 29-8099-08
9/10	BI 29-8099-10
11/12	BI 29-8099-12
13/14	BI 29-8099-14
15/16	BI 29-8099-16
17/18	BI 29-8099-18
19/20	BI 29-8099-20
21/22	BI 29-8099-22
23/24	BI 29-8099-24
25/26	BI 29-8099-26

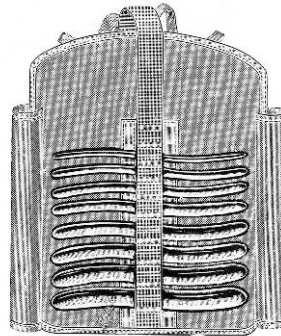

Pieces per set set

BI 29-8100-00	08	3/4 - 17/18 mm	BI 29-8100-30
BI 29-8100-01	13	1/2 - 25/26 mm	BI 29-8100-31

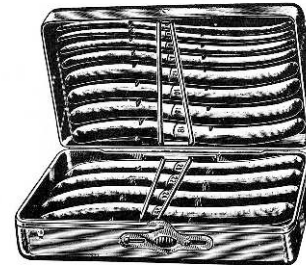



mm	
3/6	BI 29-8102-03
4/7	BI 29-8102-04
5/8	BI 29-8102-05
6/9	BI 29-8102-06
7/10	BI 29-8102-07
8/11	BI 29-8102-08
9/12	BI 29-8102-09
10/13	BI 29-8102-10
11/14	BI 29-8102-11
12/15	BI 29-8102-12
13/16	BI 29-8102-13
14/17	BI 29-8102-14
15/18	BI 29-8102-15
16/19	BI 29-8102-16
17/20	BI 29-8102-17
18/21	BI 29-8102-18

Hawklin Ambler
 BI 29-8101-12 Set of 12 3/6 - 14/17
 BI 29-8101-16 Set of 16 3/6 - 18/21
 17 cm long



Hank
 BI 29-8103-30

mm	
9/10	BI 29-8104-10
11/12	BI 29-8104-12
13/14	BI 29-8104-14
15/16	BI 29-8104-16
17/18	BI 29-8104-18
19/20	BI 29-8104-20

Set
 BI 29-8105-00
 double ended
 27 cm

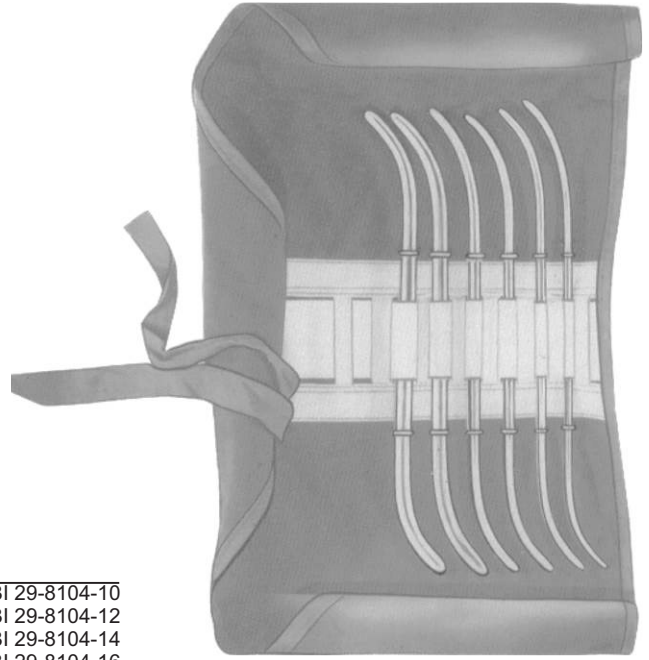

mm	
13/15	BI 29-8106-15
17/19	BI 29-8106-19
21/23	BI 29-8106-23
25/27	BI 29-8106-27
29/31	BI 29-8106-31
33/35	BI 29-8106-35
37/39	BI 29-8106-39
41/43	BI 29-8106-43

Pratt

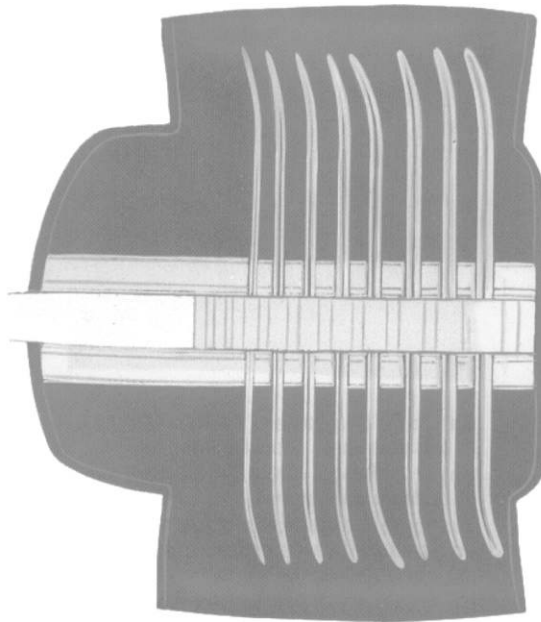

Set
 BI 29-8106-00
 double ended
 29 cm

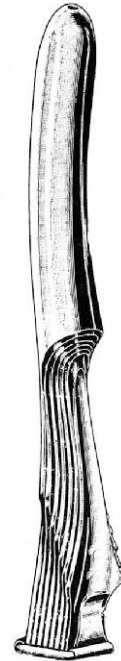

Jolly

BI 29-8107-00 set of 5
 BI 29-8107-01 3-7 mm dia
 BI 29-8107-02 5-9 mm dia
 BI 29-8107-03 7-12 mm dia
 BI 29-8107-04 9-15 mm dia
 BI 29-8107-05 12-18 mm dia

Tip 4 mm



Sims

32 cm/12½"
 cm
 BI 29-8108-01 s/s



Martin (Simpson)

32 cm/12½"
 cm
 BI 29-8109-01 s/s



Valleix

BI 29-8110-25
 25 cm/10"



Collin

BI 29-8111-28
 28 cm/11"



Braun

BI 29-8112-28
 28 cm/11"

Uterine Depressor

Rigid

Malleable

cm / in
 BI 29-8108-02 s/s
 BI 29-8108-03 c/p

cm / in
 BI 29-8109-02 s/s
 BI 29-8109-03 c/p



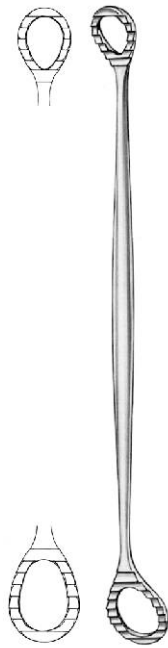

SIMS
BI 29-8113-26
26.0cm



FANO
BI 29-8114-22
22.0cm

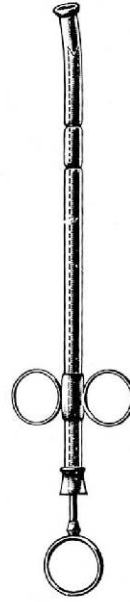

RAPID
BI 29-8115-01 200 x 8mm
BI 29-8115-02 250 x 10mm
BI 29-8115-03 250 x 12mm



SIMS
BI 29-8116-27
27.0cm

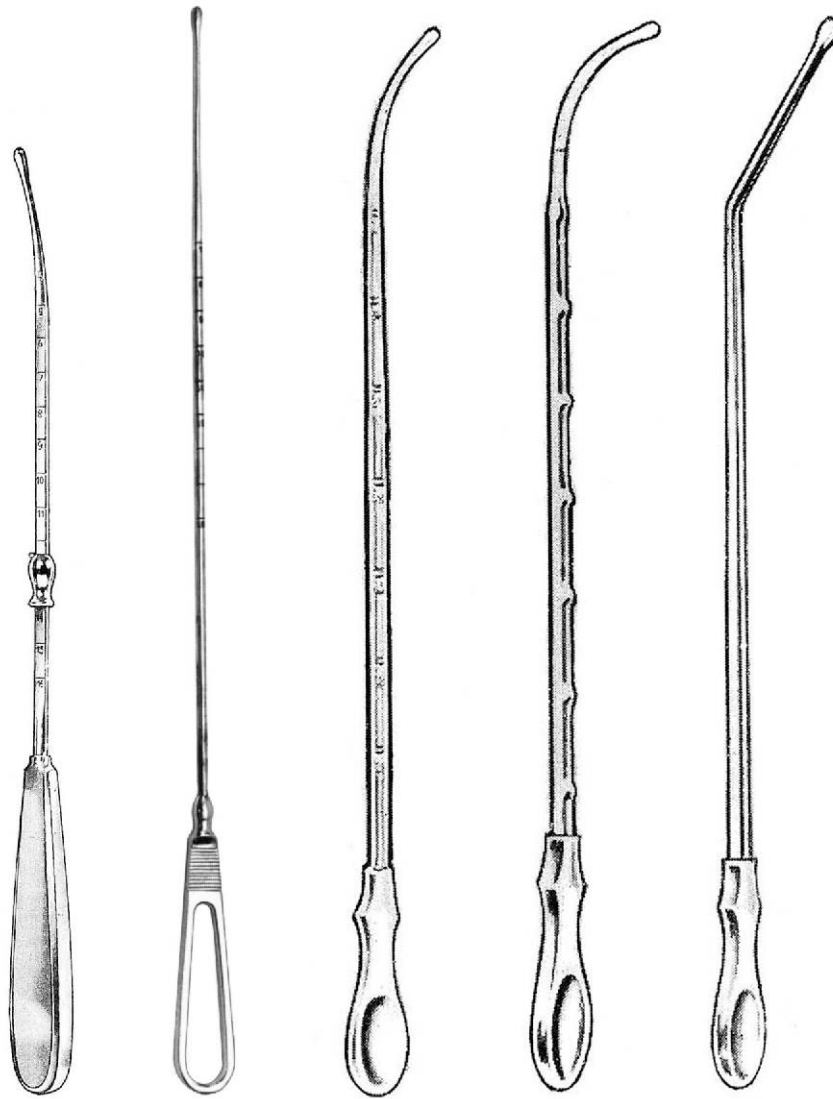

VALLEIX
 BI 29-8117-25
 25.0cm

BI 29-8118-30
 30.5cm

GALABIN
 BI 29-8119-32
 32.0cm

HORROCKS
 BI 29-8120-32
 32.0cm

SIMPSON
 BI 29-8121-32
 32.0cm



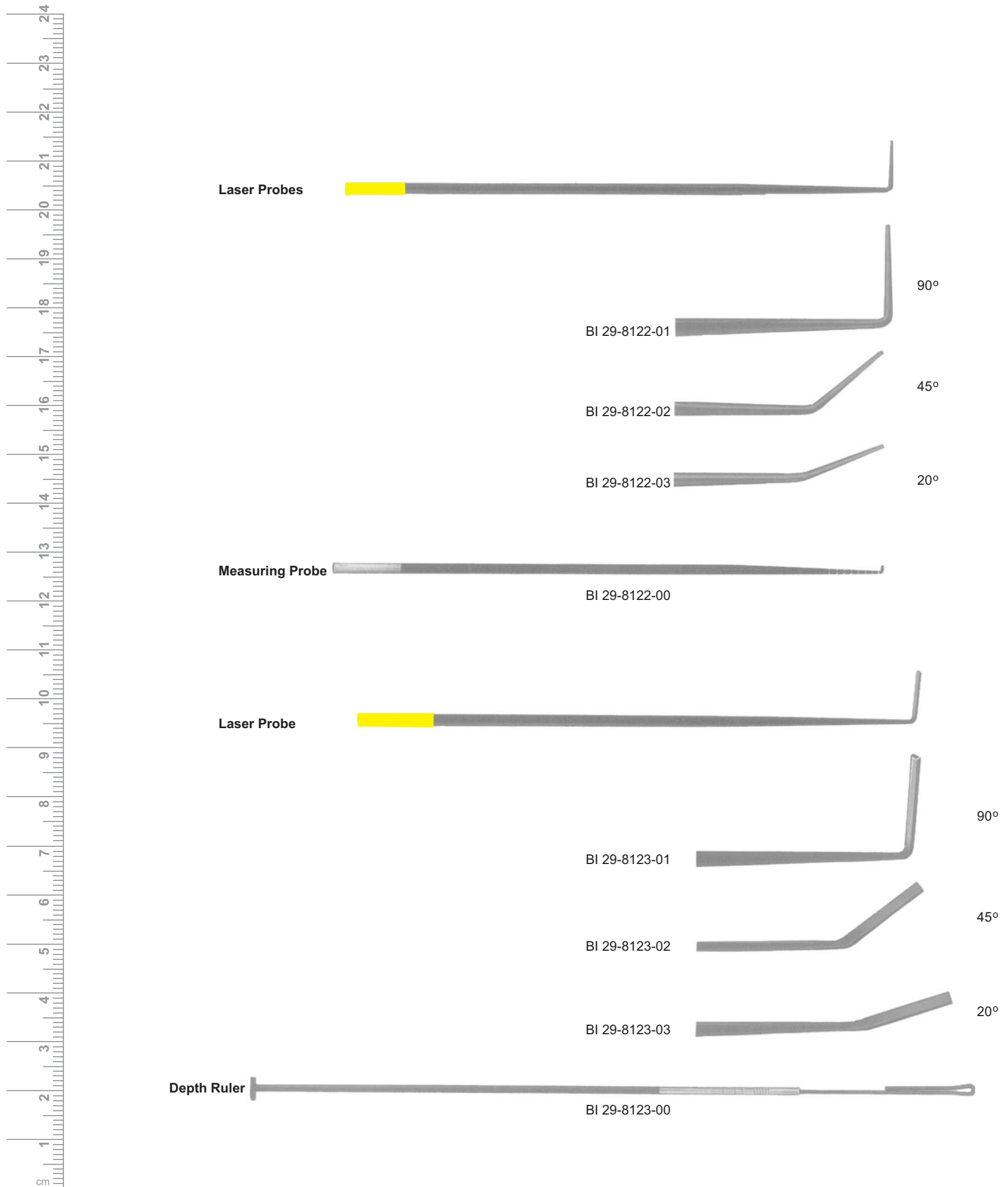

GYNECOLOGY

Measuring Instruments

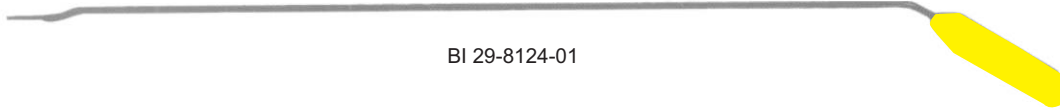

BI 29-8124-01

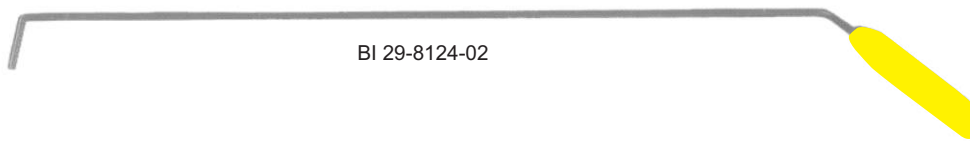

BI 29-8124-02

Hooks



BI 29-8125-01



BI 29-8125-02 Emmet



BI 29-8125-03



BI 29-8126-01



BI 29-8127-02





Ayre
BI 29-8128-23
23 cm/9"



Simon
BI 29-8129-22
22 cm/8¾"



Simon
BI 29-8130-22
22 cm/8¾"



Emmet
22 cm/8¾"



BI 29-8131-01



BI 29-8131-02



BI 29-8131-03



BI 29-8131-04



BI 29-8131-05



BI 29-8132-24
24.0cm



Doyen
BI 29-8132-17 T-Handle
BI 29-8132-18 Loop-Handle
17 cm/6¾"



Doyen
BI 29-8133-17 T-Handle
BI 29-8133-18 Loop-Handle
17 cm/6¾"



Segond
BI 29-8134-27
27 cm/10½"

GYNECOLOGY

Secretion Spoon



BI 29-8135-27
 27 cm/10½"



Muenchen
 27 cm/10½"



BI 29-8136-04
 4 mm



BI 29-8136-05
 5 mm



Randall
 24 cm/9½"

4 mmØ
 BI 29-8137-01 1 mm
 BI 29-8137-02 2 mm
 BI 29-8137-03 3 mm
 BI 29-8137-04 4 mm



Novak
 23 cm/9"

BI 29-8138-01 1 mm
 BI 29-8138-02 2 mm
 BI 29-8138-03 3 mm
 BI 29-8138-04 4 mm



Novak-Schoeckaert
 BI 29-8139-24
 24 cm/9"





Kevorkian
 BI 29-8140-30 malleable
 30 cm/12"



Kevorkian
 BI 29-8142-30 malleable
 30 cm/12"



Townsend
 BI 29-8144-30 malleable
 31 cm/12¼"



Duncan
 BI 29-8146-31
 31 cm/12¼"



Duncan
 BI 29-8147-31
 31 cm/12¼"

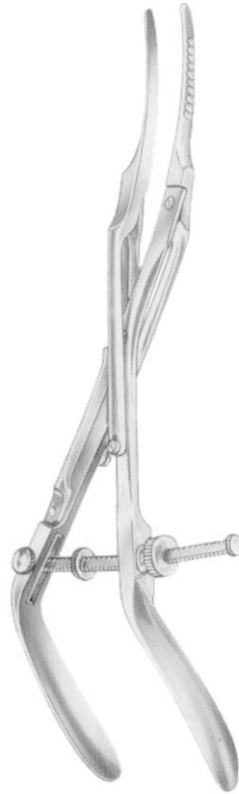

Goodell
BI 29-8148-34
34 cm/13 1/2"



Kogan-Laser
24 cm

Black Insulated



BI 29-8149-28



BI 29-8150-28



BI 29-8151-28
28 cm/11"

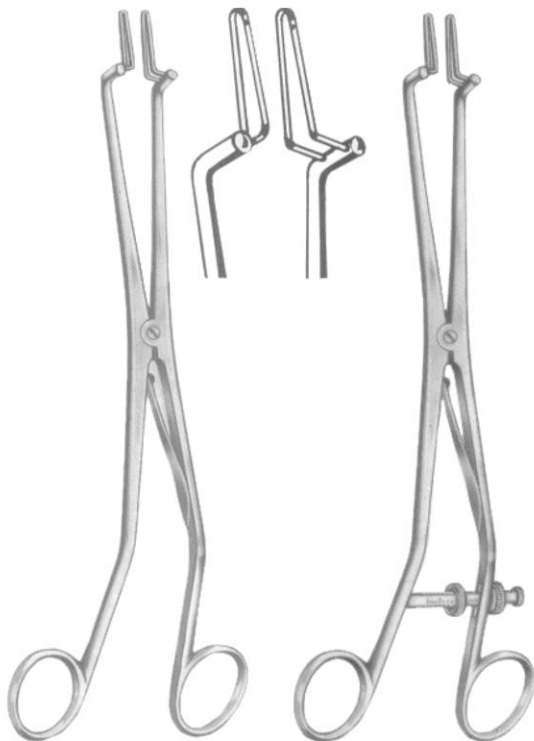

Kogan
BI 29-8152-24 24 cm
BI 29-8152-48 48 cm

Kogan
BI 29-8153-24 24 cm
BI 29-8153-48 48 cm

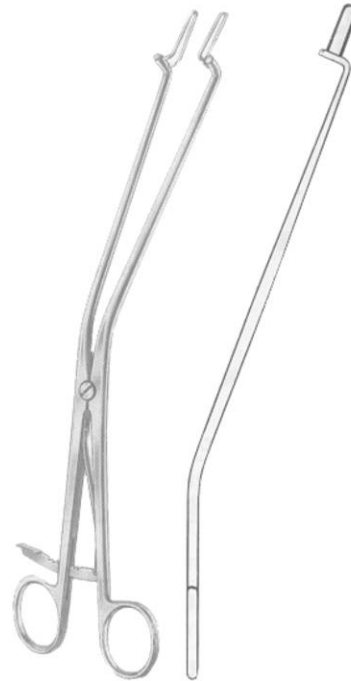

Kogan
28 cm/11"



BI 29-8154-28



BI 29-8155-28





Martin
BI 29-8156-27
27 cm/10½"

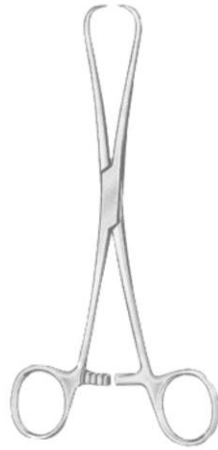

Stauder-Moore
BI 29-8157-17
17 cm/6¾"



Barrett
BI 29-8158-18
18 cm/7"



Schroeder
BI 29-8159-10
25 cm/10"



Teale
BI 29-8159-18 18.0cm
BI 29-8159-23 23.0cm
BI 29-8159-25 25.0cm



Braun
BI 29-8160-25
25 cm/10"



Collin-Pozzi
BI 29-8161-25
25 cm/10"



Pozzi
BI 29-8162-01
25.5 cm/10¼"

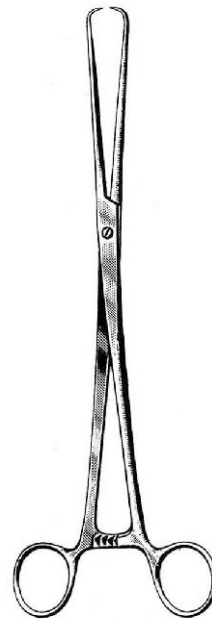

Pozzi
BI 29-8162-02
25.0cm



Duplay
BI 29-8163-28
28 cm/11"

GYNECOLOGY

Amniotome for the
 amnion Bladder



Skene
 BI 29-8164-24
 24 cm/9½"

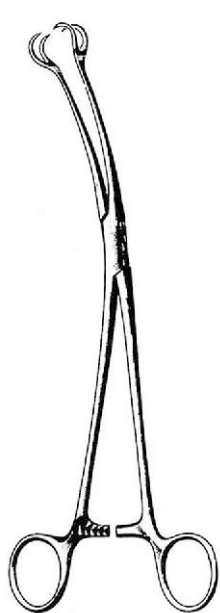

Skene
 BI 29-8164-23
 23.0cm



Beacham
 BI 29-8165-26
 26 cm/10¼"



Czerny
 BI 29-8166-20
 20.5 cm/8¼"



BI 29-8167-26
 26 cm/10¼"



Henrotin
 BI 29-8167-20
 20.0cm



Abel
 BI 29-8168-27
 27.0cm



Schroeder
 BI 29-8168-23 23 cm
 BI 29-8168-24 24 cm
 BI 29-8168-26 26 cm
 Straight



Schroeder
 BI 29-8169-23
 BI 29-8169-24
 BI 29-8169-26

Curved on Flat



Schroeder
 BI 29-8170-23
 BI 29-8170-24
 BI 29-8170-26

Curved Sideway

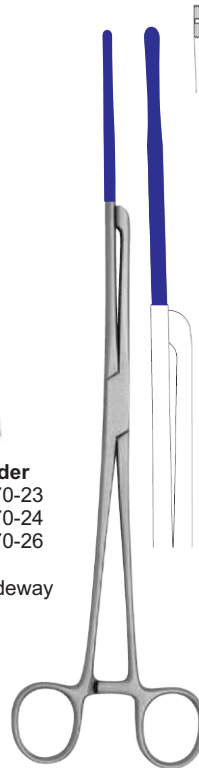

Atrauma
 BI 29-8171-29
 Vulsellum Forcep
 29cm/11 ½"

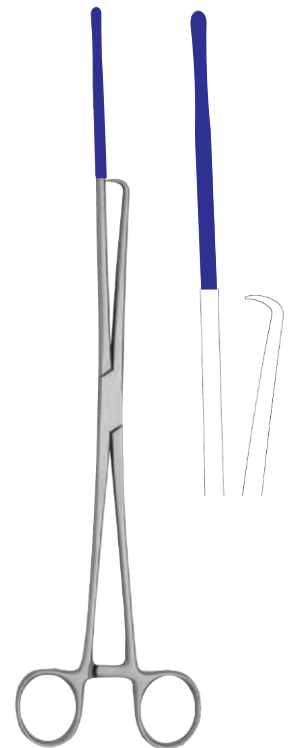

Luer
 BI 29-8172-30
 Vulsellum Forcep
 30.5cm/12"





Atrauma
BI 29-8173-29
29cm/11 1/2"



Bozeman
BI 29-8174-27
27cm/10 1/2"

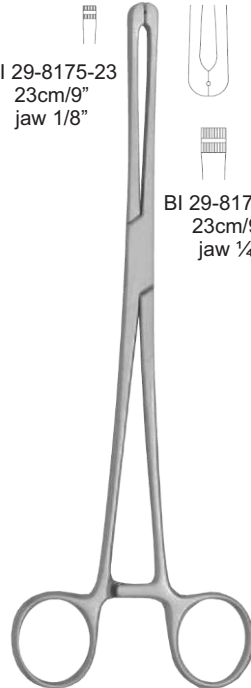

BI 29-8175-23
23cm/9"
jaw 1/8"

BI 29-8176-23
23cm/9"
jaw 1/4"



Rotunda
BI 29-8177-27
27cm/10 1/2"

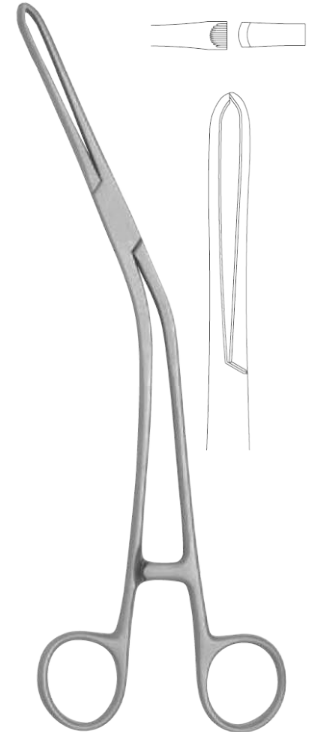

Bierer
BI 29-8178-24
24cm/9 1/2"

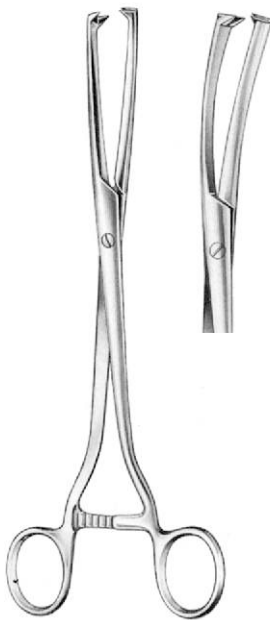

MUSEUX curved
straight 24.0cm sideways

- | | | |
|---------------|------|---------------|
| BI 29-8179-06 | 6mm | BI 29-8179-16 |
| BI 29-8179-08 | 8mm | BI 29-8179-18 |
| BI 29-8179-10 | 10mm | BI 29-8179-20 |

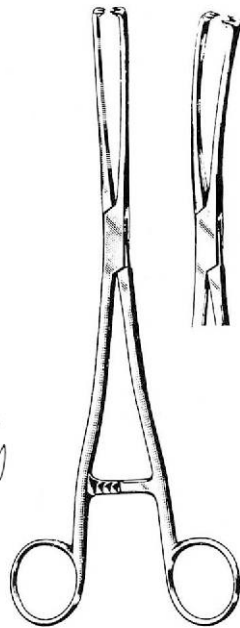

MUSEUX curved
straight 24.0cm sideways

- | | | |
|---------------|------|---------------|
| BI 29-8180-06 | 6mm | BI 29-8180-16 |
| BI 29-8180-08 | 8mm | BI 29-8180-18 |
| BI 29-8180-10 | 10mm | BI 29-8180-20 |

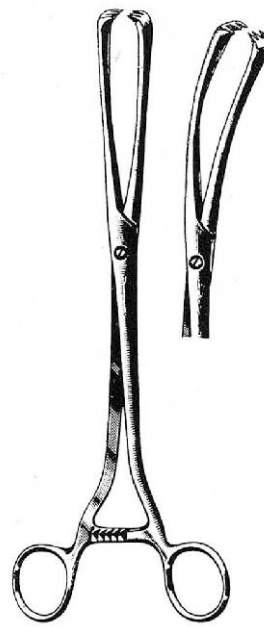

MUSEUX curved
straight 26.0cm sideways

- | | | |
|---------------|------|---------------|
| BI 29-8181-09 | 9mm | BI 29-8181-16 |
| BI 29-8181-11 | 11mm | BI 29-8181-18 |
| BI 29-8181-13 | 13mm | BI 29-8181-20 |

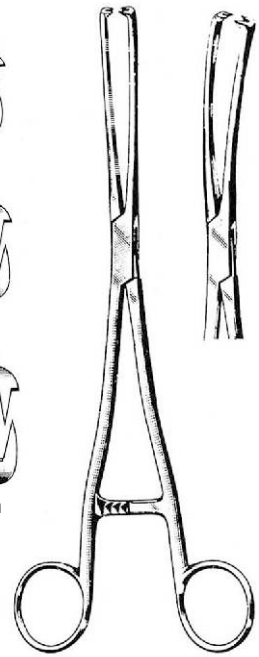

MUSEUX curved
straight 26.0cm sideways

- | | | |
|---------------|------|---------------|
| BI 29-8182-09 | 9mm | BI 29-8182-16 |
| BI 29-8182-11 | 11mm | BI 29-8182-18 |
| BI 29-8182-13 | 13mm | BI 29-8182-20 |

GYNECOLOGY

For the amnion Bladder



Pratt
 BI 29-8183-28
 28 cm/11"



Iowa
 BI 29-8184-26
 26 cm/10¼"



Jacobs
 Straight Curved Sideway
 BI 29-8185-21 BI 29-8186-21
 21 cm/8¼"



Bonney Polypus
 BI 29-8187-26
 24 cm/9 ½"



Kelly
 BI 29-8188-32
 32 cm/12½"



Heywood-Bliith
 BI 29-8189-20
 20 cm/8"



Heywood-Bliith
 BI 29-8190-25
 25 cm/10"



Noto
 BI 29-8191-27
 27 cm/10½"

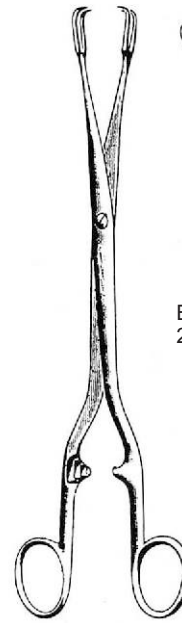

Schroeder
 BI 29-8192-01
 26.0cm

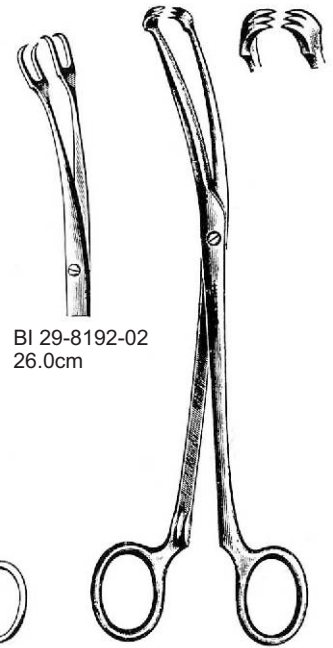

Teale
 BI 29-8193-18 18.0cm
 BI 29-8193-23 23.0cm



GYNECOLOGY



THOMS-GAYLOR
 BI 29-8202-24
 24.0cm



THOMS-GAYLOR
 BI 29-8203-22 22.0cm
 BI 29-8203-24 24.0cm



VAN DOREN
 24.0cm

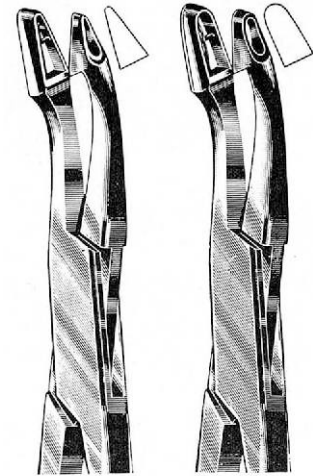

BI 29-8204-01 BI 29-8204-02



GELLHORN
 BI 29-8205-23
 23.0cm



FAURE
 BI 29-8206-21
 21.0cm



SCHUBERT
 BI 29-8207-26
 26.0cm



SCHUBERT
 BI 29-8208-21 21.0cm
 BI 29-8208-29 29.0cm



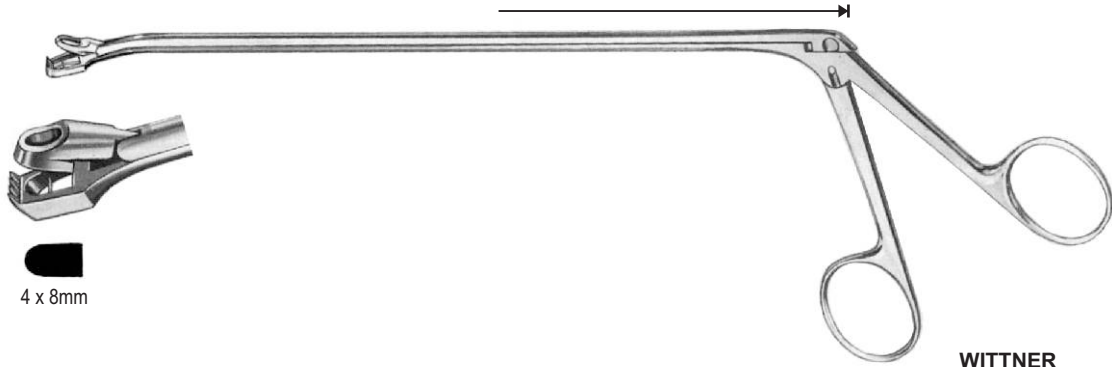

WITTNER

BI 29-8209-23 23.0cm (straight)
 BI 29-8210-23 23.0cm (angled)

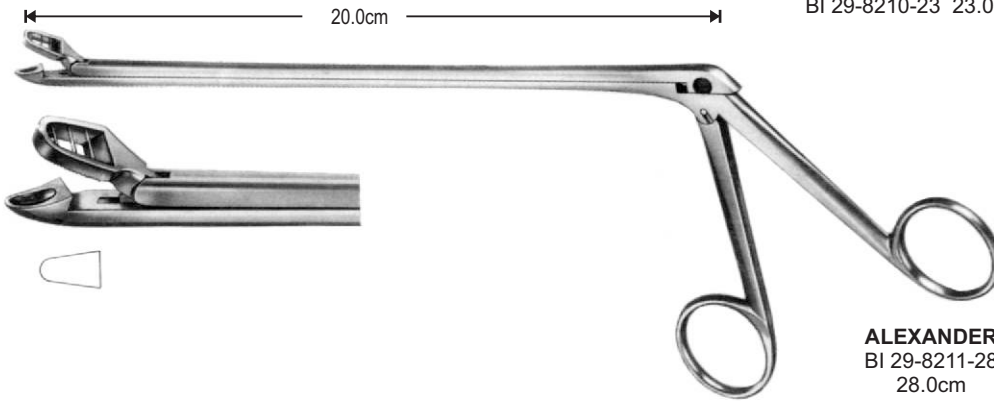

ALEXANDER

BI 29-8211-28
 28.0cm

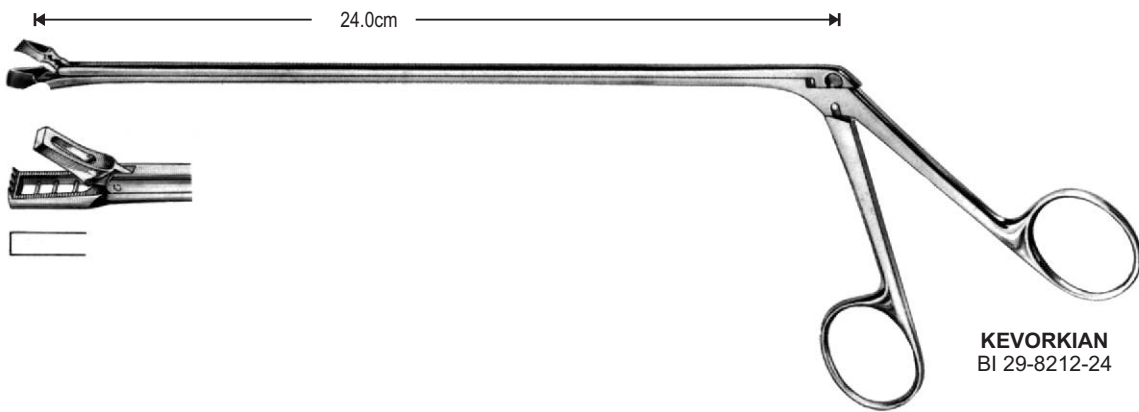

KEVORKIAN

BI 29-8212-24

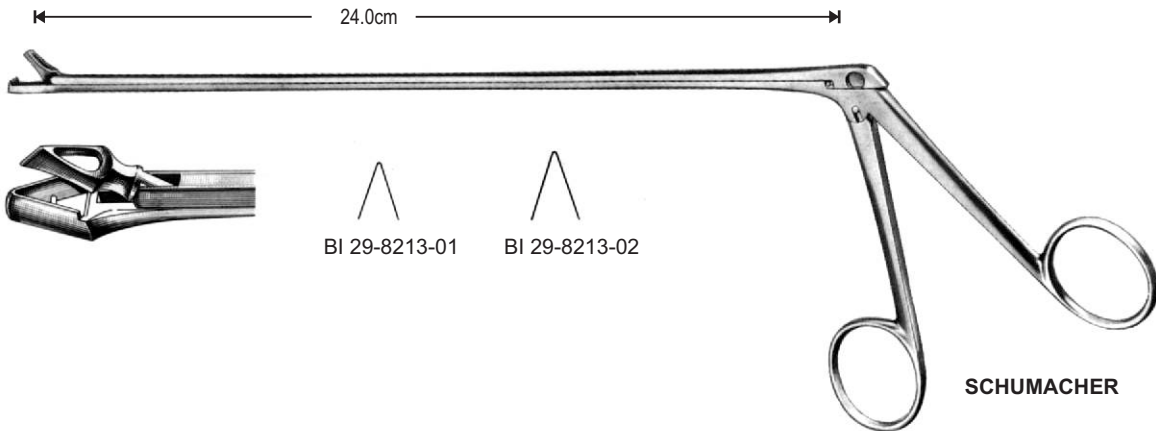

SCHUMACHER

GYNECOLOGY



2.3 x 4.2 mm

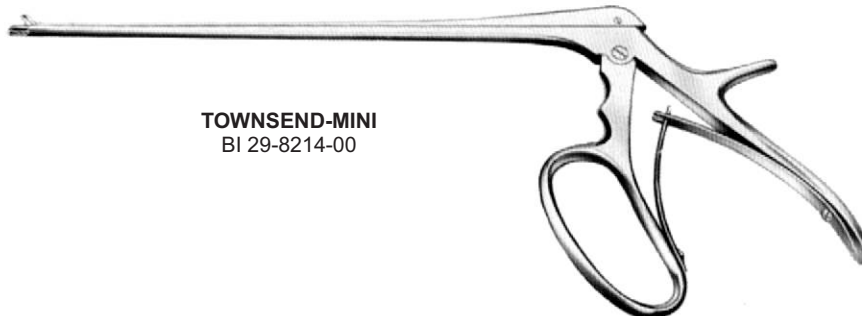

TOWNSEND-MINI
 BI 29-8214-00



3 x 9.5 mm



TISCHLER-KEVORKIAN
 BI 29-8215-00



4 x 6.5 mm

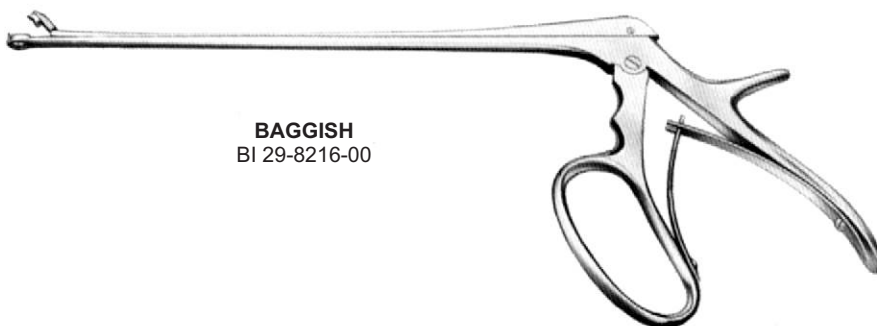

BAGGISH
 BI 29-8216-00



4 x 8 mm

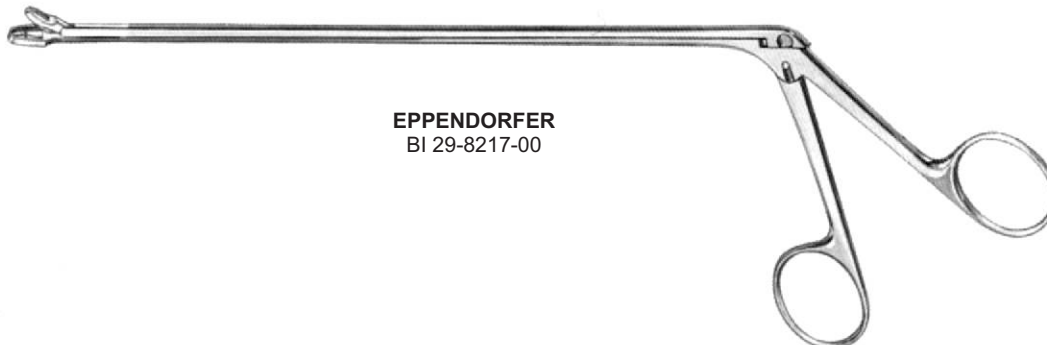

EPPENDORFER
 BI 29-8217-00



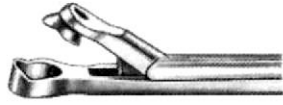

oval
7 x 5 mm

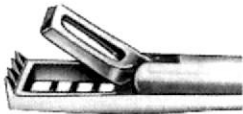

3 x 8 mm



Fig.1

TISCHLER-MORGAN



Fig.3

oval 3.7 x 5 mm



Fig.4

KEVORKIAN



Fig.5

mini

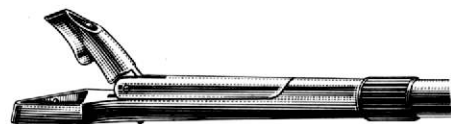

Tip only



BI 29-8221-01

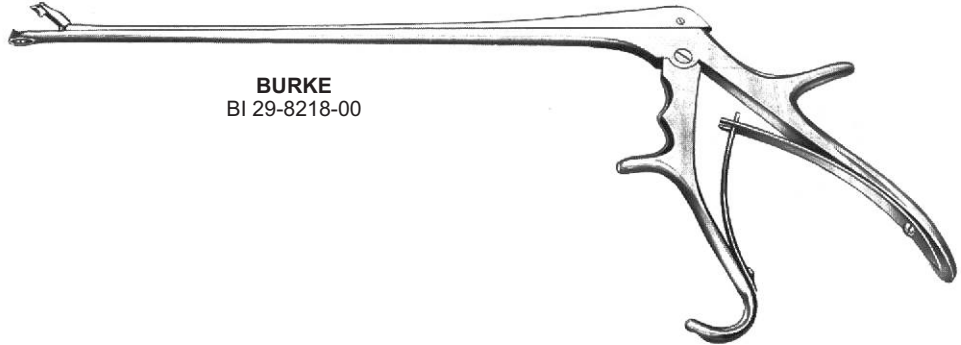

BURKE
BI 29-8218-00

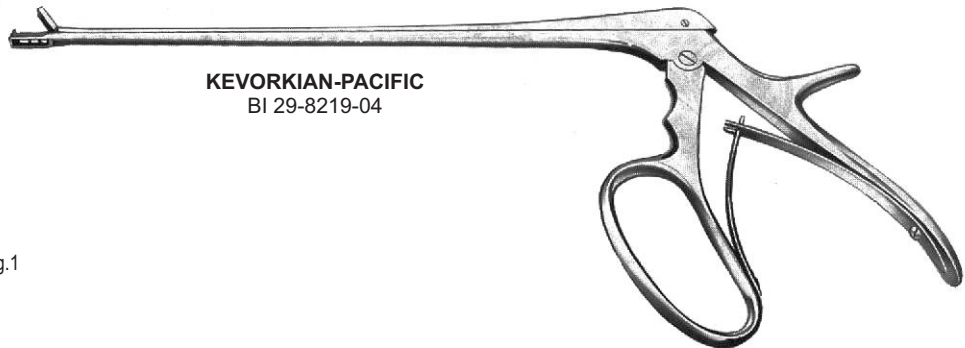

KEVORKIAN-PACIFIC
BI 29-8219-04

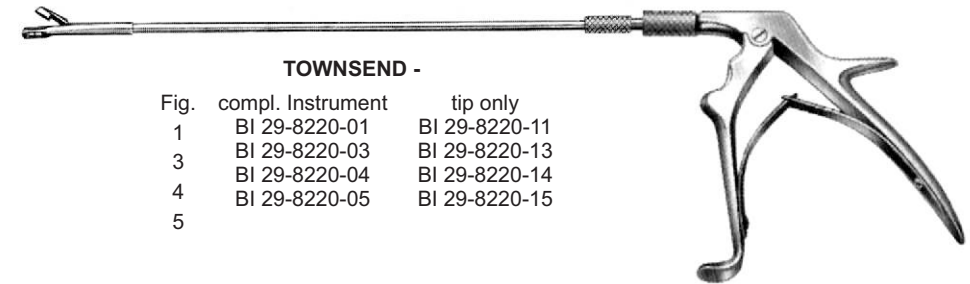

TOWNSEND -

Fig.	compl. Instrument	tip only
1	BI 29-8220-01	BI 29-8220-11
3	BI 29-8220-03	BI 29-8220-13
4	BI 29-8220-04	BI 29-8220-14
5	BI 29-8220-05	BI 29-8220-15

BI 29-8220-99
handle only

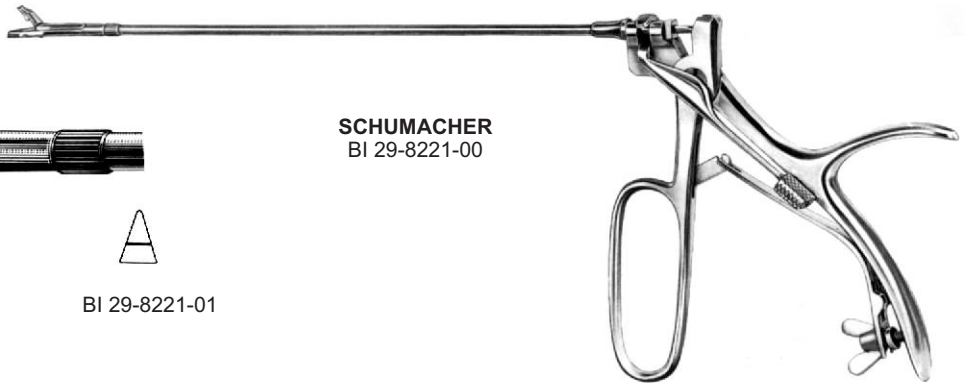

SCHUMACHER
BI 29-8221-00

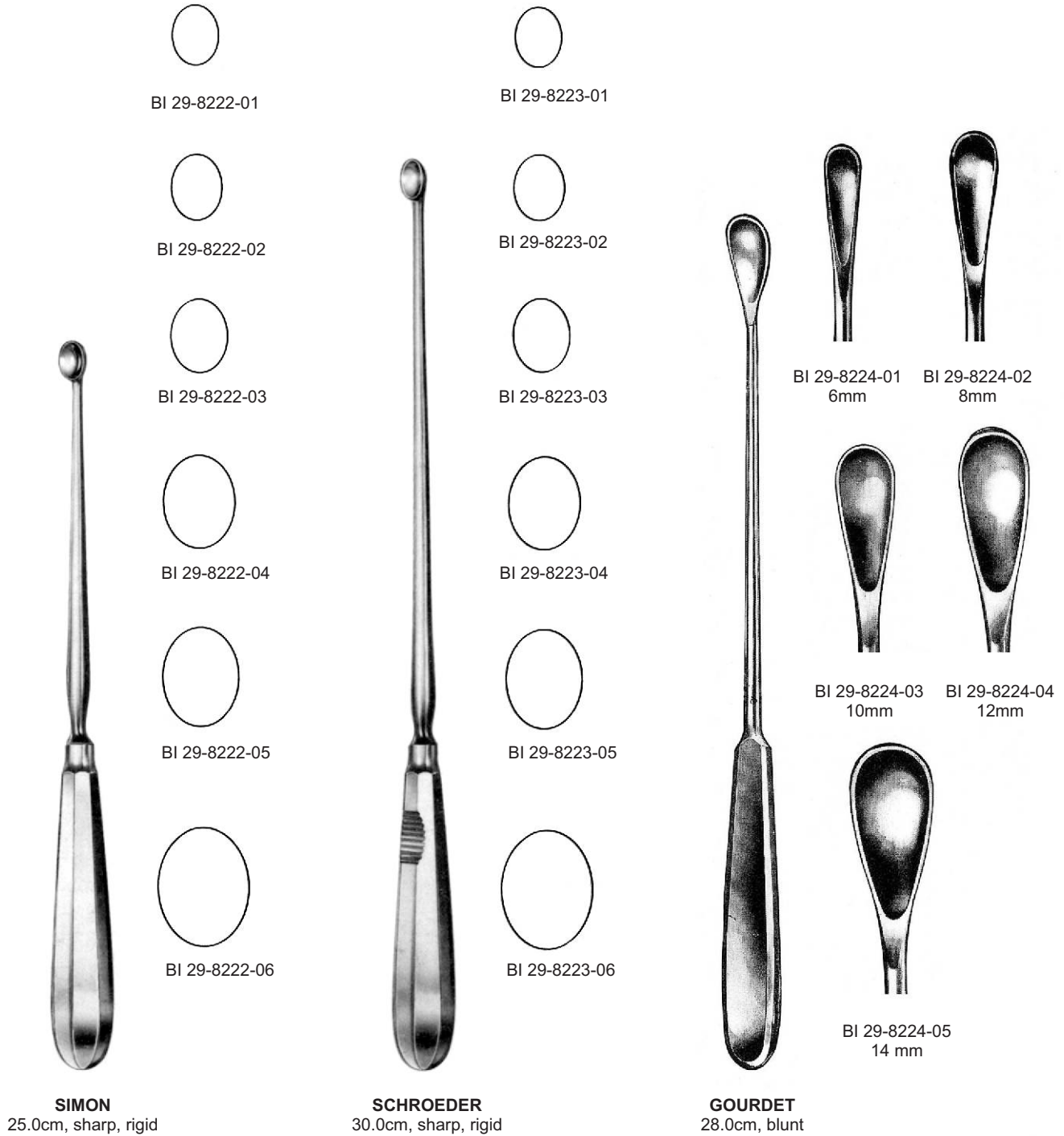

SIMON
 25.0cm, sharp, rigid

SCHROEDER
 30.0cm, sharp, rigid

GOURDET
 28.0cm, blunt

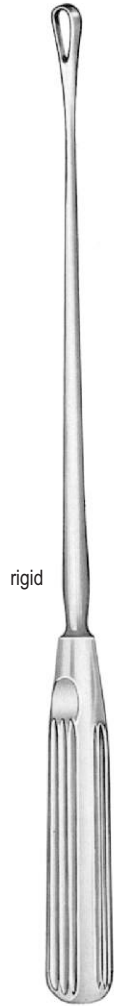

SIMS
31.0cm

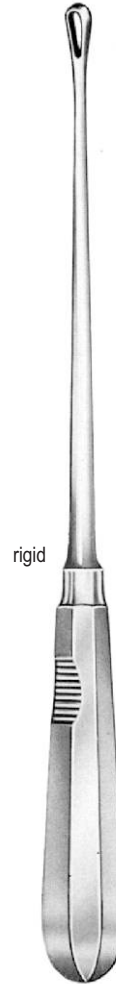
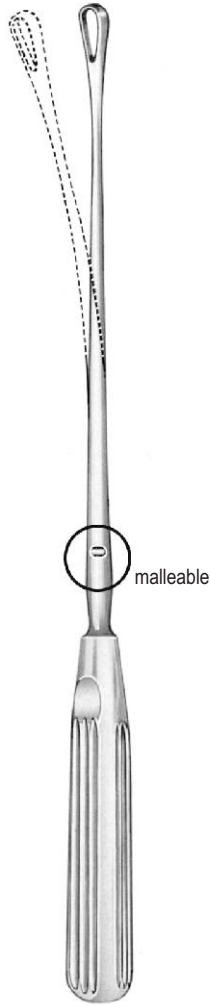

RECAMIER
31.0cm



Fig	sharp	blunt	sharp	blunt	Fig	sharp	blunt	sharp	blunt
00	BI 29-8225-05	BI 29-8226-05	BI 29-8227-05	BI 29-8228-05	00	BI 29-8229-05	BI 29-8230-05	BI 29-8231-05	BI 29-8232-05
0	BI 29-8225-06	BI 29-8226-06	BI 29-8227-06	BI 29-8228-06	0	BI 29-8229-06	BI 29-8230-06	BI 29-8231-06	BI 29-8232-06
1	BI 29-8225-07	BI 29-8226-07	BI 29-8227-07	BI 29-8228-07	1	BI 29-8229-07	BI 29-8230-07	BI 29-8231-07	BI 29-8232-07
2	BI 29-8225-08	BI 29-8226-08	BI 29-8227-08	BI 29-8228-08	2	BI 29-8229-08	BI 29-8230-08	BI 29-8231-08	BI 29-8232-08
3	BI 29-8225-09	BI 29-8226-09	BI 29-8227-09	BI 29-8228-09	3	BI 29-8229-09	BI 29-8230-09	BI 29-8231-09	BI 29-8232-09
4	BI 29-8225-11	BI 29-8226-11	BI 29-8227-11	BI 29-8228-11	4	BI 29-8229-11	BI 29-8230-11	BI 29-8231-11	BI 29-8232-11
5	BI 29-8225-12	BI 29-8226-12	BI 29-8227-12	BI 29-8228-12	5	BI 29-8229-12	BI 29-8230-12	BI 29-8231-12	BI 29-8232-12
6	BI 29-8225-14	BI 29-8226-14	BI 29-8227-14	BI 29-8228-14	6	BI 29-8229-14	BI 29-8230-14	BI 29-8231-14	BI 29-8232-14
7	BI 29-8225-15	BI 29-8226-15	BI 29-8227-15	BI 29-8228-15	7	BI 29-8229-15	BI 29-8230-15	BI 29-8231-15	BI 29-8232-15
8	BI 29-8225-16	BI 29-8226-16	BI 29-8227-16	BI 29-8228-16	8	BI 29-8229-16	BI 29-8230-16	BI 29-8231-16	BI 29-8232-16
9	BI 29-8225-19	BI 29-8226-19	BI 29-8227-19	BI 29-8228-19	9	BI 29-8229-19	BI 29-8230-19	BI 29-8231-19	BI 29-8232-19
10	BI 29-8225-20	BI 29-8226-20	BI 29-8227-20	BI 29-8228-20	10	BI 29-8229-20	BI 29-8230-20	BI 29-8231-20	BI 29-8232-20
11	BI 29-8225-21	BI 29-8226-21	BI 29-8227-21	BI 29-8228-21	11	BI 29-8229-21	BI 29-8230-21	BI 29-8231-21	BI 29-8232-21
12	BI 29-8225-23	BI 29-8226-23	BI 29-8227-23	BI 29-8228-23	12	BI 29-8229-23	BI 29-8230-23	BI 29-8231-23	BI 29-8232-23
13	BI 29-8225-25	BI 29-8226-25	BI 29-8227-25	BI 29-8228-25	13	BI 29-8229-25	BI 29-8230-25	BI 29-8231-25	BI 29-8232-25
14	BI 29-8225-30	BI 29-8226-30	BI 29-8227-30	BI 29-8228-30	14	BI 29-8229-30	BI 29-8230-30	BI 29-8231-30	BI 29-8232-30
15	BI 29-8225-35	BI 29-8226-35	BI 29-8227-35	BI 29-8228-35	15	BI 29-8229-35	BI 29-8230-35	BI 29-8231-35	BI 29-8232-35
16	BI 29-8225-40	BI 29-8226-40	BI 29-8227-40	BI 29-8228-40	16	BI 29-8229-40	BI 29-8230-40	BI 29-8231-40	BI 29-8232-40

GYNECOLOGY

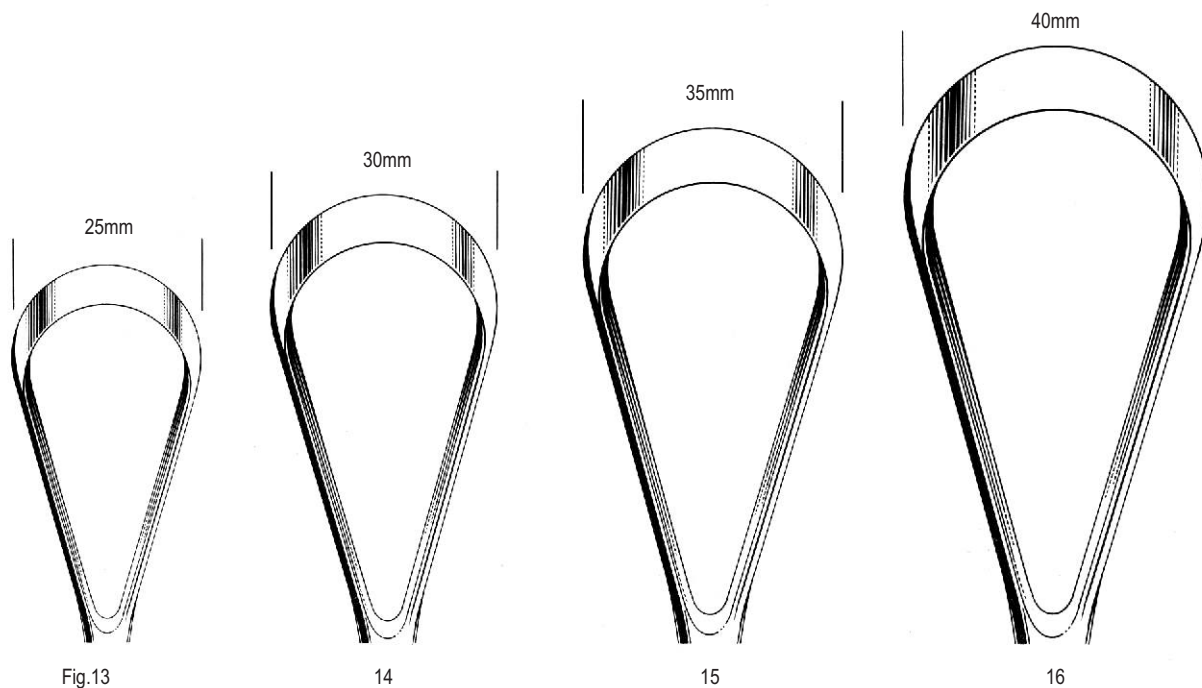
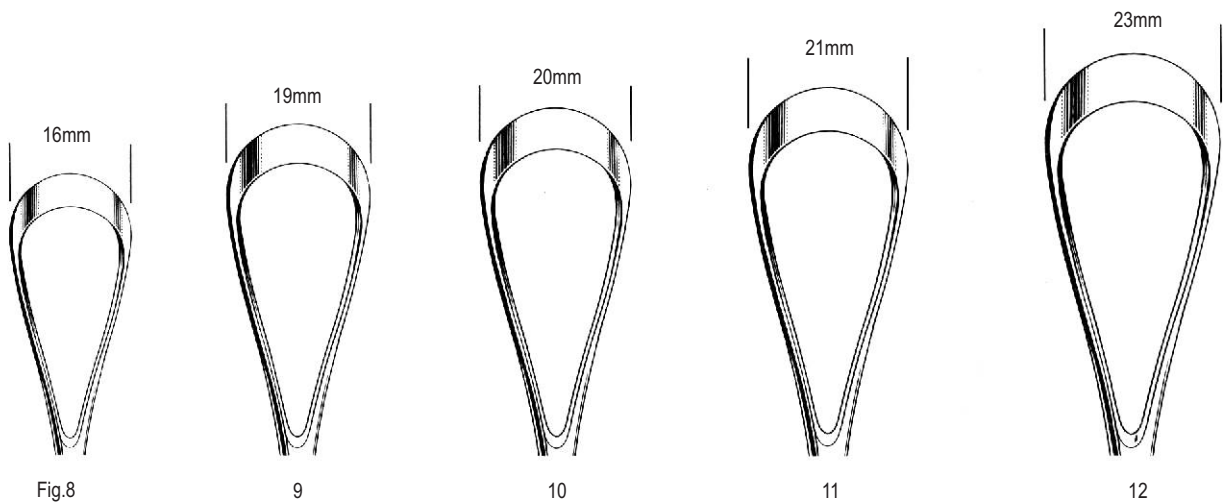
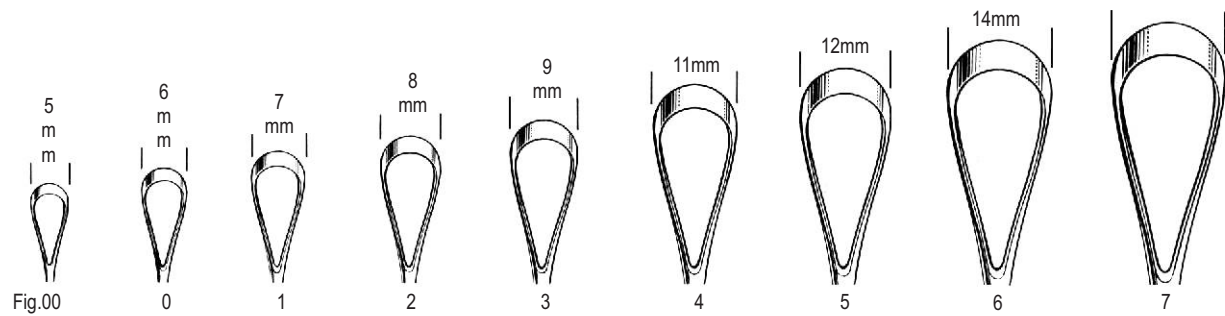



BUMM
34.0cm

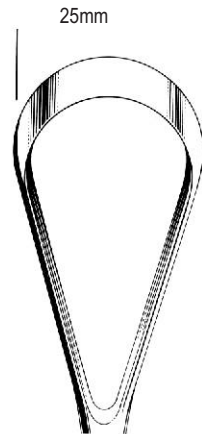
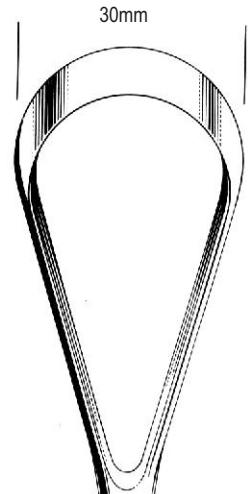
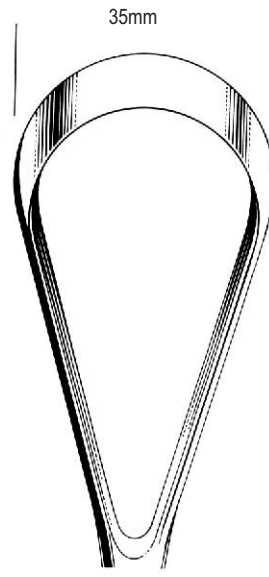

Fig. 13



14



15

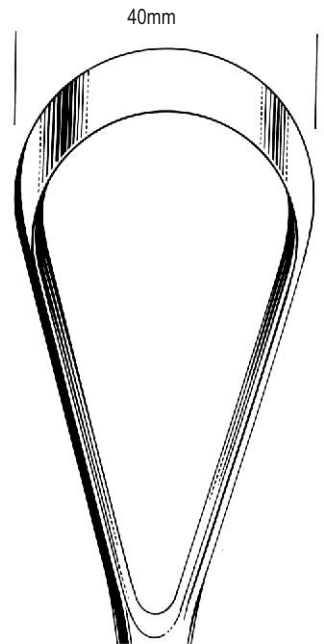

16

Fig	sharp	blunt	sharp	blunt
13	BI 29-8233-25	BI 29-8234-25	BI 29-8235-25	BI 29-8236-25
14	BI 29-8233-30	BI 29-8234-30	BI 29-8235-30	BI 29-8236-30
15	BI 29-8233-35	BI 29-8234-35	BI 29-8235-35	BI 29-8236-35
16	BI 29-8233-40	BI 29-8234-40	BI 29-8235-40	BI 29-8236-40

GYNECOLOGY

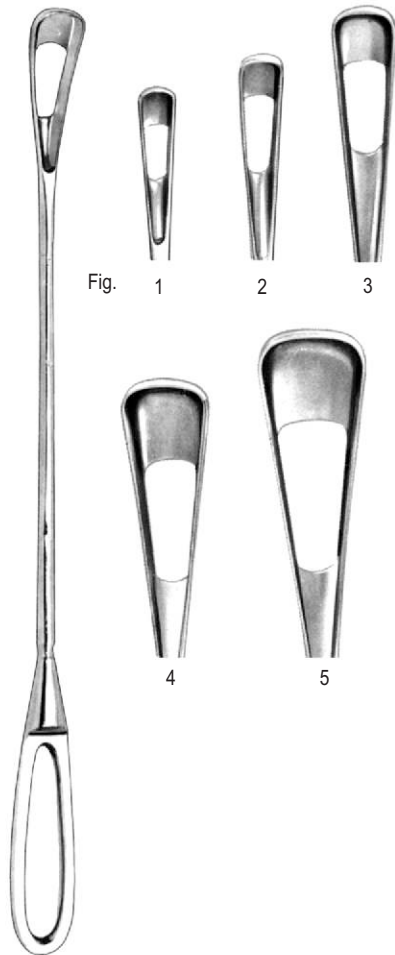

Fig. 1 2 3

4 5

28.0cm

Fig.		mm
1	BI 29-8237-01	4.5
2	BI 29-8237-02	6
3	BI 29-8237-03	9
4	BI 29-8237-04	12
5	BI 29-8237-05	15

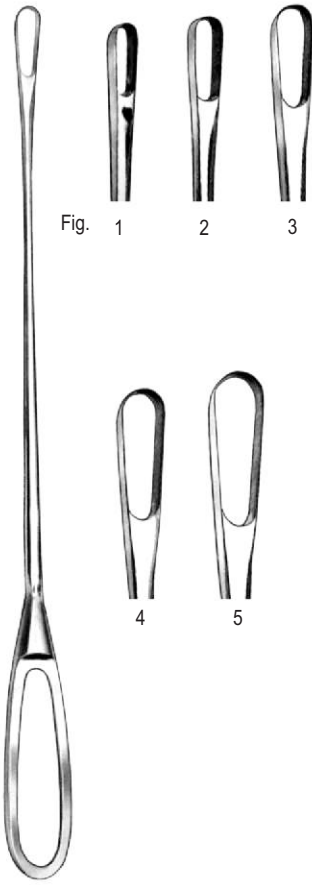

Fig. 1 2 3

4 5

27.0cm

Fig.	
1	BI 29-8238-01
2	BI 29-8238-02
3	BI 29-8238-03
4	BI 29-8238-04
5	BI 29-8238-05

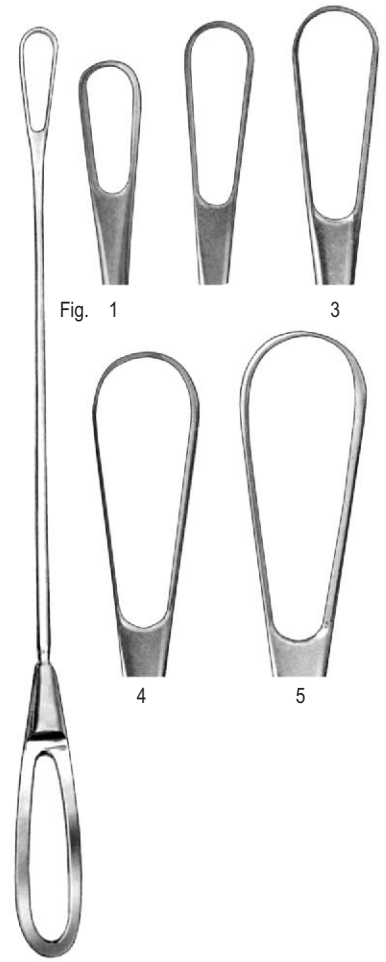

Fig. 1 3

4 5

28.0cm

Fig.	
1	BI 29-8239-01
2	BI 29-8239-02
3	BI 29-8239-03
4	BI 29-8239-04
5	BI 29-8239-05



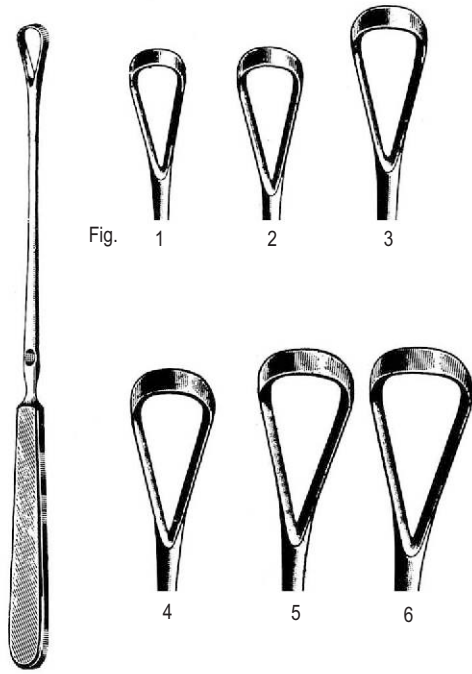
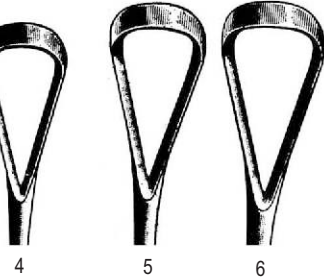

Fig.

1 2 3



4 5 6

SIMS
25.0cm

	sharp	Fig	blunt
BI 29-8240-01	1	BI 29-8241-01	
BI 29-8240-02	2	BI 29-8241-02	
BI 29-8240-03	3	BI 29-8241-03	
BI 29-8240-04	4	BI 29-8241-04	
BI 29-8240-05	5	BI 29-8241-05	
BI 29-8240-06	6	BI 29-8241-06	

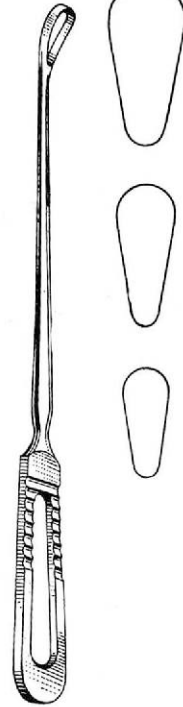

SIMS
25.0cm

	sharp	Fig	blunt
BI 29-8242-01	1	BI 29-8243-01	
BI 29-8242-02	2	BI 29-8243-02	
BI 29-8242-03	3	BI 29-8243-03	

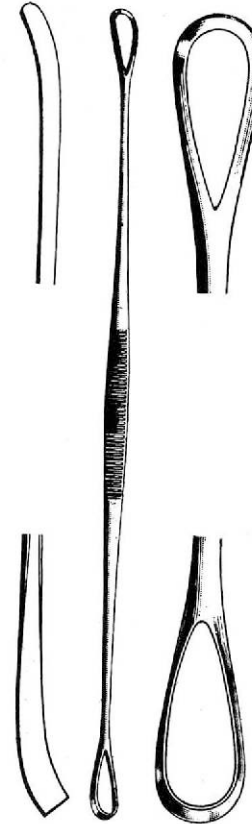

sharp / blunt
BI 29-8244-27 27.0cm

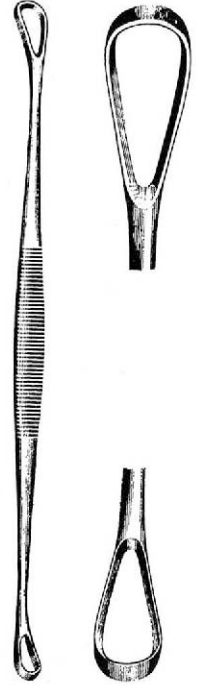

BLAKE
sharp / blunt
BI 29-8245-27 27.0cm

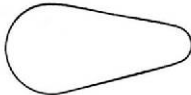

SIMS
BI 29-8246-25
25.0cm, sharp



SIMS
BI 29-8247-25
25.0cm, sharp / blunt

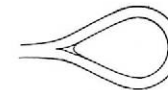



Fig.1

UNIVERSAL
28.0cm

- Fig
 1 BI 29-8248-01
 2 BI 29-8248-02
 3 BI 29-8248-03

RHEINSTADTER
29.0cm

- | | | |
|---------------|---------|---------------|
| | sharp | blunt |
| BI 29-8249-01 | 7.9 mm | BI 29-8250-01 |
| BI 29-8249-02 | 11.1 mm | BI 29-8250-02 |
| BI 29-8249-03 | 14.3 mm | BI 29-8250-03 |

CHELSEA HOSPITAL
BI 29-8251-31 31.0cm

DONALD
sharp
BI 29-8252-33 33.0cm



RANDALL
 24.0cm
 1mm dia. BI 29-8253-01
 2mm dia. BI 29-8253-02
 3mm dia. BI 29-8253-03
 4mm dia. BI 29-8253-04

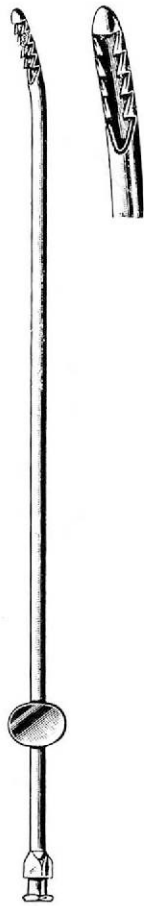

NOVAK
 23.0cm
 BI 29-8254-01
 BI 29-8254-02
 BI 29-8254-03
 BI 29-8254-04

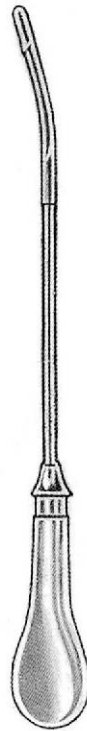

SHERMAN
 BI 29-8255-23 23.0cm
 3.5mm dia.

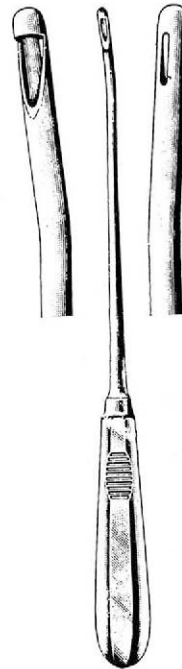

MUENCHEN
 BI 29-8256-27 27.0cm



with basket

KEVORKIAN
 30.0cm
 BI 29-8257-12 1.2mm BI 29-8258-12
 BI 29-8257-40 4.0mm BI 29-8258-40