

28

- EN** Ophthalmology
- DE** Ophthalmologie
- ES** Oftalmología
- FR** Ophtalmologie
- IT** Oftalmologia

Page 651 to 681

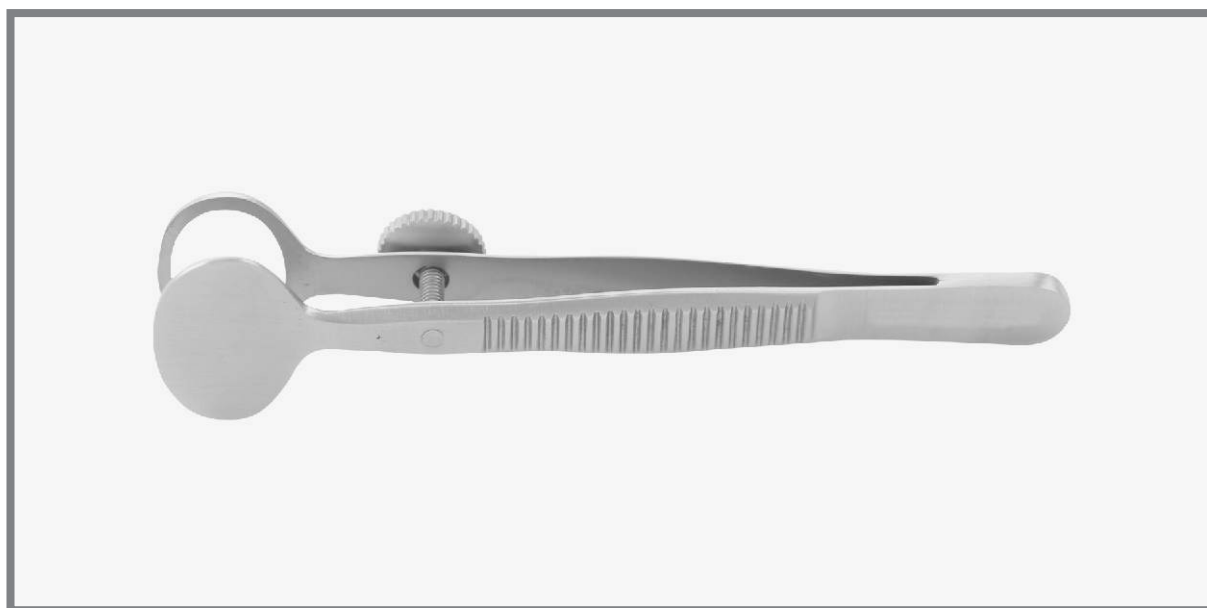



Children **Weiss** Adults  
BI 28-7601-07 BI 28-7602-09  
7 cm/2¾" 9 cm/3½"



Children **Weiss** Adults  
BI 28-7603-07 BI 28-7604-09  
7 cm/2¾" 9 cm/3½"

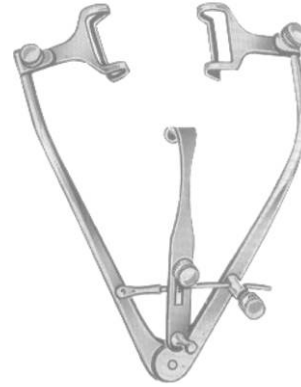

**Park**  
BI 28-7605-08  
8 cm/3¼"

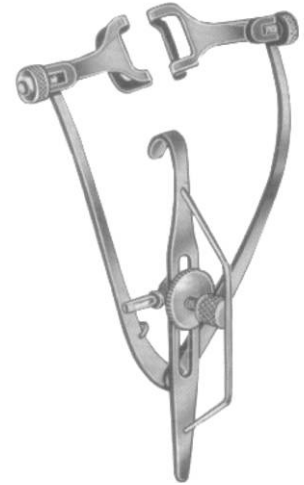

**Park-Guyton**  
BI 28-7606-08  
8 cm/3¼"



**Park-Maumenee**  
BI 28-7607-08  
8 cm/3¼"



**Barraquer (Colibri)**  
Children Adults  
BI 28-7608-03 BI 28-7609-04  
3 cm/1¼" 4 cm/1½"



**Sauer**  
BI 28-7612-03  
3 cm/1¼"



**Barraquer**  
BI 28-7610-04  
4 cm/1½"



**Bowman**  
BI 28-7611-07  
7 cm/2¾"



**Goldstein**  
BI 28-7613-03  
3 cm/1¼"



**Pley**  
BI 28-7614-06  
6 cm/2¼"

For left eye

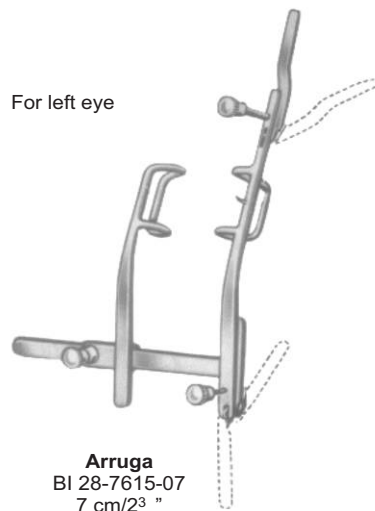

**Arruga**  
BI 28-7615-07  
7 cm/2¾"

For right eye

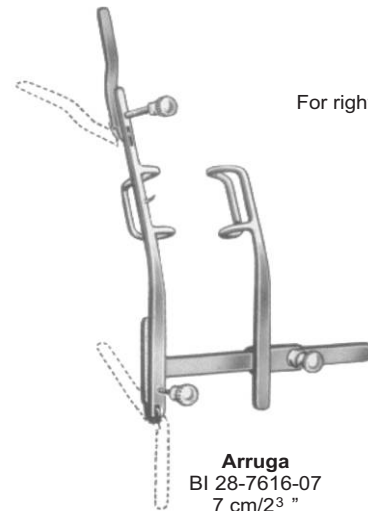

**Arruga**  
BI 28-7616-07  
7 cm/2¾"



**Mellinger-Axenfeld**  
 BI 28-7617-07  
 7 cm/2 3/4"



**Mellinger-Axenfeld**  
 BI 28-7618-07  
 7 cm/2 3/4"



Children **Mellinger** Adults  
 BI 28-7619-05 BI 28-7620-07  
 5 cm/2 3/4" 7 cm/2 3/4"



Children **Mellinger Beard** Adults  
 BI 28-7621-05 BI 28-7622-07  
 5 cm/2" 7 cm/2 3/4"



**Knapp Clark**  
 BI 28-7623-08  
 8 cm/3 1/4"



Children **Graefe** Adults  
 BI 28-7624-06 BI 28-7625-09  
 6 cm/2 1/2" 9 cm/3 1/2"



**Lancaster**  
 BI 28-7626-08  
 8 cm/3 1/4"



Children **Williams** Adults  
 BI 28-7627-07 BI 28-7628-08  
 7 cm/2 3/4" 8 cm/3 1/4"



**Lister-Burch**  
 BI 28-7629-08  
 8 cm/3 1/4"



**Weiss**  
 BI 28-7630-08  
 8 cm/3 1/4"



**Murdock**  
 BI 28-7631-05  
 5 cm/2"



**Mueller**  
 BI 28-7632-07  
 7 cm/2 3/4"



**Critchett**  
 BI 28-7633-06  
 6 cm/2 1/2"



**Castroviejo**  
 BI 28-7634-08  
 8 cm/3 1/4"





**Schepens**  
 BI 28-7635-13  
 13 cm/5"



**DeBlarres**  
 BI 28-7636-13  
 13 cm/5"



**Conway**  
 BI 28-7637-13  
 13 cm/5"

8 mm



**DeBlarres**  
 13 cm/5"



BI 28-7638-12  
 12 mm

BI 28-7638-14  
 14 mm

BI 28-7638-16  
 16 mm

BI 28-7638-18  
 18 mm

Lid plate



**Jaeger**  
 BI 28-7639-11  
 11 cm/4 1/2"

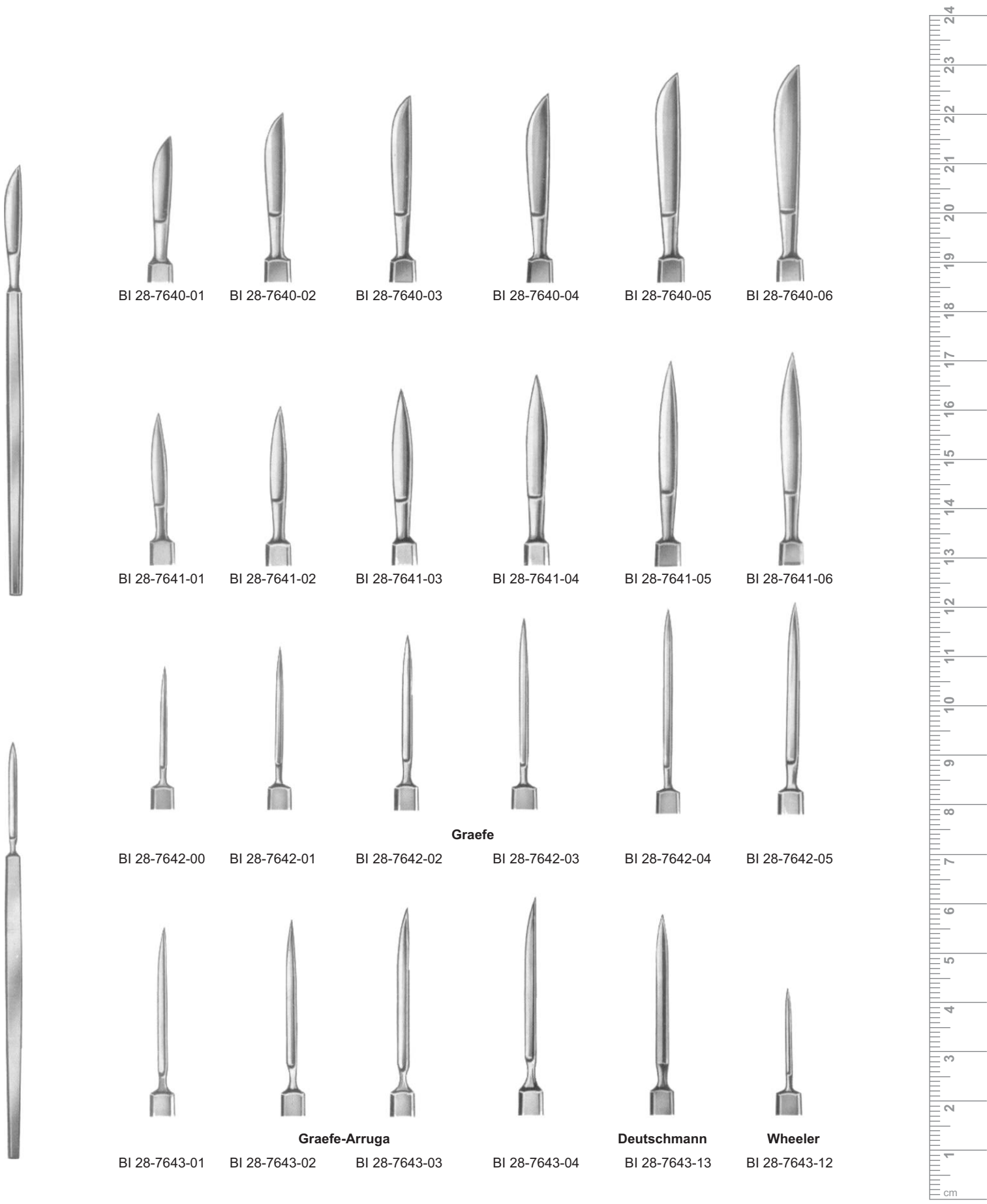

BI 28-7640-01   BI 28-7640-02   BI 28-7640-03   BI 28-7640-04   BI 28-7640-05   BI 28-7640-06

BI 28-7641-01   BI 28-7641-02   BI 28-7641-03   BI 28-7641-04   BI 28-7641-05   BI 28-7641-06

BI 28-7642-00   BI 28-7642-01   BI 28-7642-02   BI 28-7642-03   BI 28-7642-04   BI 28-7642-05

BI 28-7643-01   BI 28-7643-02   BI 28-7643-03   BI 28-7643-04   BI 28-7643-13   BI 28-7643-12

**Graefe**

**Graefe-Arruga**

**Deutschmann**

**Wheeler**



**Jaeger**  
BI 28-7644-01



BI 28-7644-02



BI 28-7644-03



BI 28-7644-04



BI 28-7645-01



BI 28-7645-02



BI 28-7645-03



BI 28-7645-04



BI 28-7646-01



BI 28-7646-02



BI 28-7646-03



BI 28-7646-04



BI 28-7647-01



BI 28-7647-02



BI 28-7647-03



BI 28-7647-04

**Jaeger-Grieshaber**



BI 28-7648-01



BI 28-7648-02



BI 28-7648-03



BI 28-7648-04

**Jaeger-Grieshaber**

OPHTHALMOLOGY

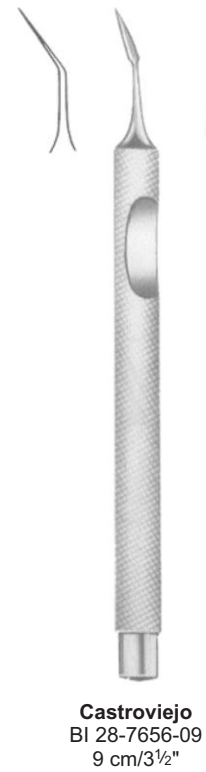
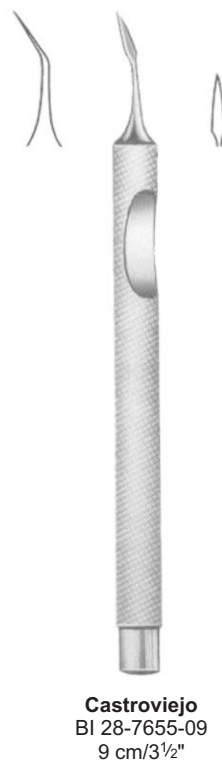
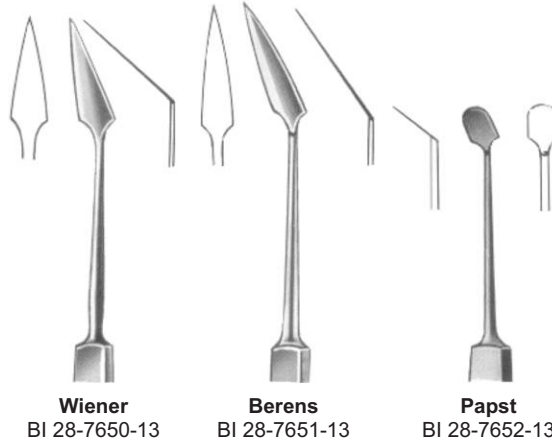
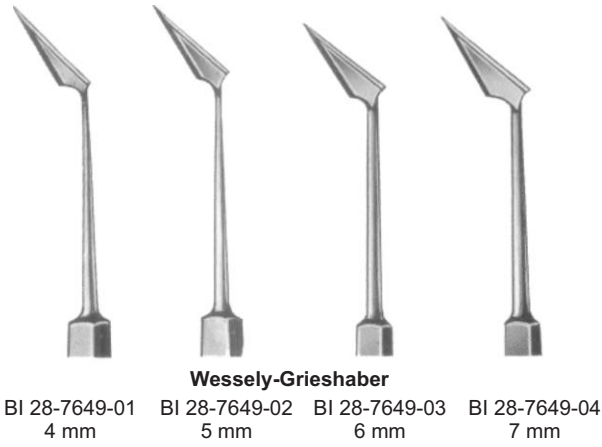



**Mod. Hamburg**  
BI 28-7657-12



**Graefe**  
BI 28-7658-13



BI 28-7659-01



**Weber**  
BI 28-7659-02



BI 28-7659-03



**Bowman**  
BI 28-7660-04  
0.4 mm



**Bowman**  
BI 28-7660-05  
0.5 mm



**Bowman**  
BI 28-7660-06  
0.6 mm



**Bowman**  
BI 28-7660-07  
0.7 mm



**Bowman**  
BI 28-7660-08  
0.8 mm



Left **Bowman** Right  
BI 28-7661-01 BI 28-7661-02



BI 28-7662-01



**Knapp**  
BI 28-7662-02



BI 28-7662-03



BI 28-7663-05  
5 mm



**Ziegler**  
BI 28-7663-06  
6 mm



BI 28-7663-07  
7 mm



OPHTHALMOLOGY

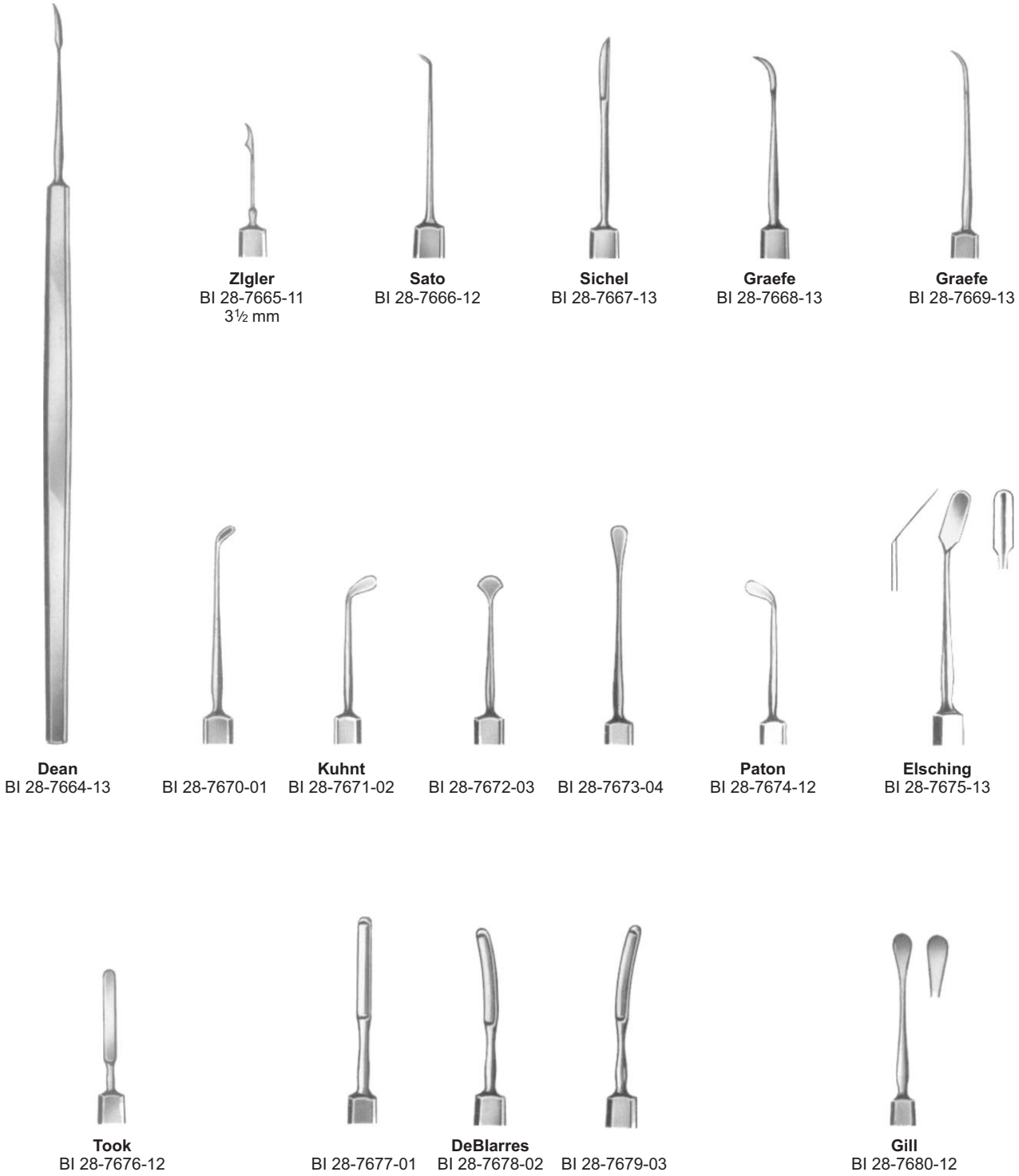



**Guthrie**  
BI 28-7681-12



**Guthrie**  
BI 28-7682-13



**Berens**  
BI 28-7683-12



**Knapp Blunt**  
BI 28-7684-13



**Rollet Sharp**  
BI 28-7685-12



**Rollet**  
BI 28-7686-12



**Fink Blunt**  
BI 28-7687-12



Right  
BI 28-7688-01  
Left  
BI 28-7688-02

10.5 cm/4 1/4"



Flexible  
BI 28-7689-03 BI 28-7689-04

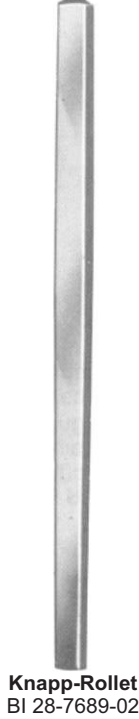

**Knapp-Rollet**  
BI 28-7689-02

OPHTHALMOLOGY



**Axenfeld**

Sharp  
 BI 28-7690-14

Blunt  
 BI 28-7691-14



**Axenfeld**

Sharp  
 BI 28-7692-14

Blunt  
 BI 28-7693-14



**Paul**  
 BI 28-7694-12



**Sautter**  
 BI 28-7695-01



**Sautter**  
 BI 28-7696-02



**Sautter**  
 BI 28-7697-03



**Arruga**  
 BI 28-7698-13



**Stevens**  
 BI 28-7699-14



**Stevens**  
 BI 28-7700-12



**Graefe**  
 BI 28-7701-01



**Graefe**  
 BI 28-7702-02



**Graefe**  
 BI 28-7703-03



**Wecker**  
 BI 28-7704-13



**Wecker**  
 BI 28-7705-13



**Stock**  
 BI 28-7706-13



**Stock**  
 BI 28-7707-13



**Culler**  
 BI 28-7708-13



**Suker**  
 BI 28-7709-14





Enucleation Scoops

Blall  
BI 28-7710-16

Large  
BI 28-7710-20

Wells

Chalazion Curettes

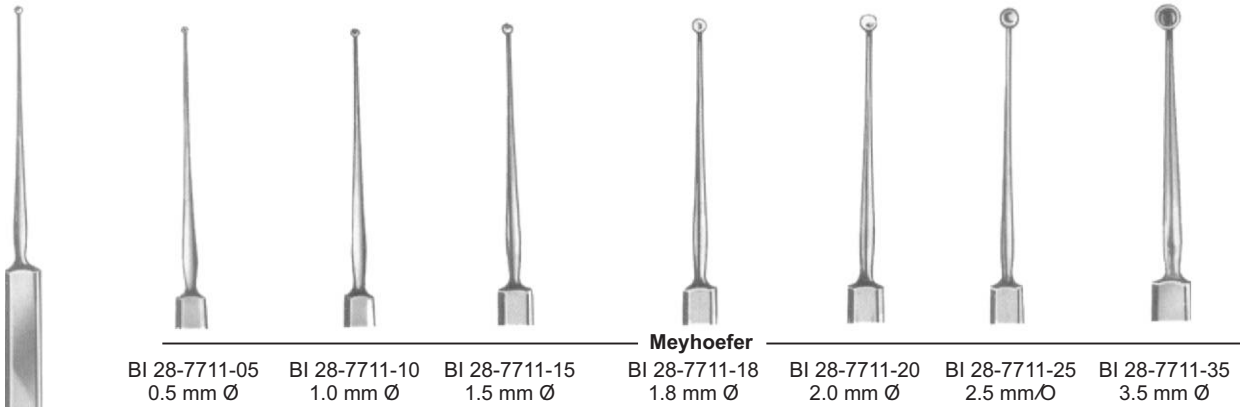

**Meyhoefer**  
 BI 28-7711-05 0.5 mm Ø    BI 28-7711-10 1.0 mm Ø    BI 28-7711-15 1.5 mm Ø    BI 28-7711-18 1.8 mm Ø    BI 28-7711-20 2.0 mm Ø    BI 28-7711-25 2.5 mm Ø    BI 28-7711-35 3.5 mm Ø

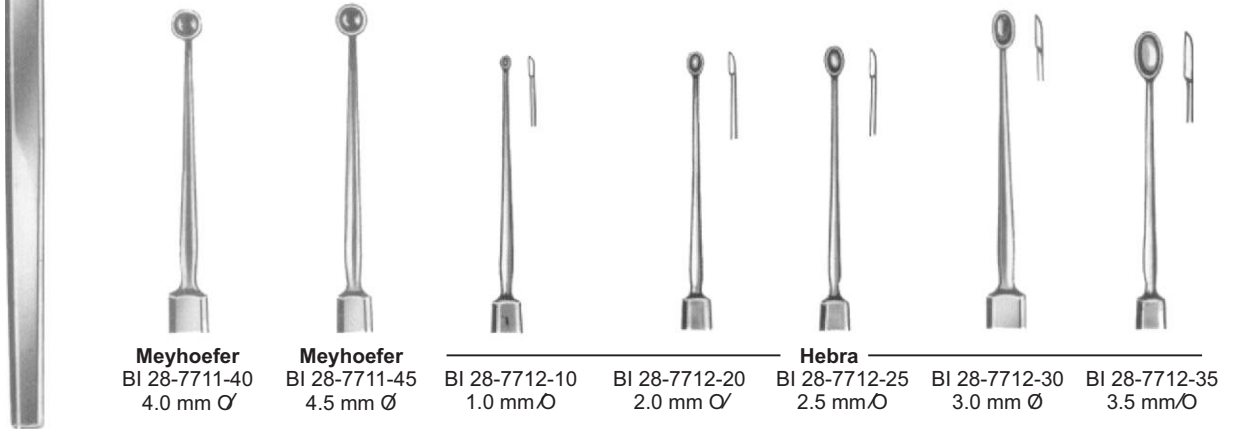

**Meyhoefer**    **Meyhoefer**    **Hebra**  
 BI 28-7711-40 4.0 mm Ø    BI 28-7711-45 4.5 mm Ø    BI 28-7712-10 1.0 mm Ø    BI 28-7712-20 2.0 mm Ø    BI 28-7712-25 2.5 mm Ø    BI 28-7712-30 3.0 mm Ø    BI 28-7712-35 3.5 mm Ø

Exenteration Scoops



BI 28-7713-01



BI 28-7713-02



**Bunge**  
 BI 28-7713-03



BI 28-7713-04



BI 28-7713-05



Chalazion Curette, Double

**Axenfeld**  
 BI 28-7714-13  
 13 cm/5"



Lachrymal Sac Dissector

**Lang**  
 BI 28-7715-13  
 13 cm/5"





Irrigating Cannulas

Straight



**Binkhorst**  
BI 28-7716-01  
22 gauge

Right



**Binkhorst**  
BI 28-7717-02  
22 gauge

Left



**Binkhorst**  
BI 28-7718-03  
22 gauge

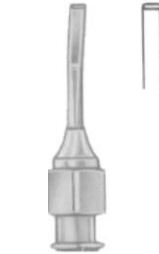

**Bonn**  
BI 28-7719-04  
20 gauge



**Bonn**  
BI 28-7720-05  
19 gauge

Probe Point

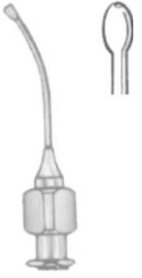

**Hamburg**  
BI 28-7721-06  
23 gauge

Irrigation/Aspiration Cannulas



**Simcoe**  
BI 28-7722-01  
23 gauge

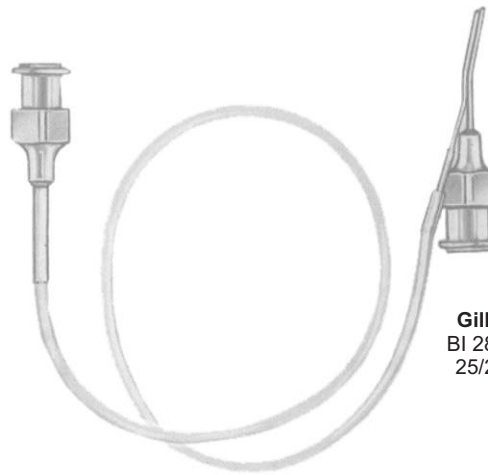

stotome Cannulas  
**Gills-Welsh**  
BI 28-7723-02  
25/23 gauge

Lens Mainpulation Cannulas



**Knolle-Kelmann**  
BI 28-7724-01  
22 gauge



**Nevyas**  
BI 28-7725-02  
22 gauge



**Kratz**  
BI 28-7726-03  
22 gauge



**Freeman**  
BI 28-7727-01  
27 gauge



**Sheets**  
 BI 28-7728-01

Irrigating Vectis Cannulas



**Knolle Pearce**  
 BI 28-7729-02

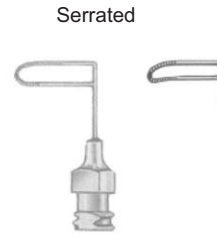

**Simcoe**  
 BI 28-7730-03

Cortex Aspiration Cannulas



**Simcoe**  
 BI 28-7731-01  
 23 gauge



**Simcoe**  
 BI 28-7732-02  
 23 gauge



**Kratz**  
 BI 28-7733-01



**Simcoe**  
 BI 28-7734-02



**Jensen**  
 BI 28-7735-03

Capsule Polishing Cannulas

Posterior





**Castroviejo**  
BI 28-7736-15



**Castroviejo**  
BI 28-7737-20  
20 mm



**Holth**  
BI 28-7738-01



**Haitz**  
BI 28-7739-02



**West**  
BI 28-7740-16  
16 cm/6 1/4"



**West**  
BI 28-7741-16  
16 cm/6 1/4"

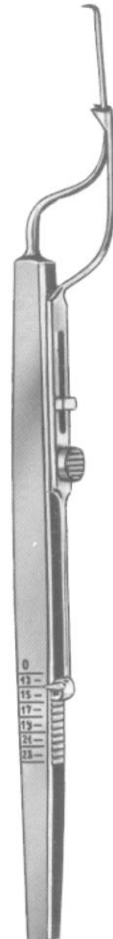

**Connin-Amsler**  
BI 28-7742-13  
13 cm/5"



**Wilder**  
BI 28-7743-01



**Wilder**  
BI 28-7744-02



**Wilder**  
BI 28-7745-03



OPHTHALMOLOGY



BI 28-7746-13 BI 28-7747-13

Needle Only  
 BI 28-7748-01

Chisel Only  
 BI 28-7748-02

Gouge Only  
 BI 28-7748-03



BI 28-7749-13

Instrumentation for D. B. Kirby Operations



BI 28-7750-10



Teeth  
 BI 28-7751-10 1:2 Teeth  
 BI 28-7752-10 2:3 Teeth



BI 28-7753-10  
 1 : 2



**Kirby**  
 BI 28-7754-10  
 10 cm/4"



**Kirby**  
 BI 28-7755-10  
 10 cm/4"



BI 28-7756-10



BI 28-7757-10





**Tuebingen**  
BI 28-7758-10  
10 cm/4"



BI 28-7759-08  
8.5 cm/3 1/2"



**Paufique**  
BI 28-7760-10  
10 cm/4"



**Barraquer**  
BI 28-7761-10  
10.5 cm/4 1/4"



**McPherson**  
BI 28-7762-10  
10 cm/4"



**McPherson**  
BI 28-7763-07  
7.5 cm/3"

OPHTHALMOLOGY



**McCullough**  
 BI 28-7764-09  
 9.5 cm/3 3/4"



**McCullough**  
 BI 28-7765-09  
 9.5 cm/3 3/4"



**Bonaccoito**  
 BI 28-7766-10  
 10 cm/4"



**Bonaccoito**  
 BI 28-7767-10  
 10 cm/4"



BI 28-7768-11  
 11 cm/4 1/2"



11 cm/4 1/2"



BI 28-7769-11  
 1 : 2



BI 28-7770-11  
 2 : 3



**Nugent**  
 10 cm/4"



BI 28-7771-01



BI 28-7772-02



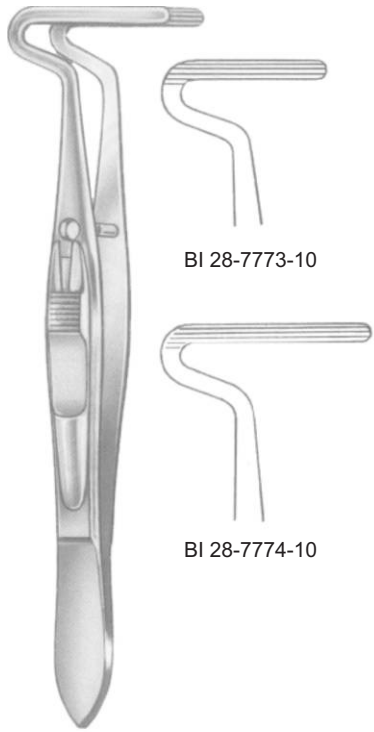

**Berke**  
10 cm/4"



**Blascovics**  
BI 28-7775-09  
9 cm/3 1/2"

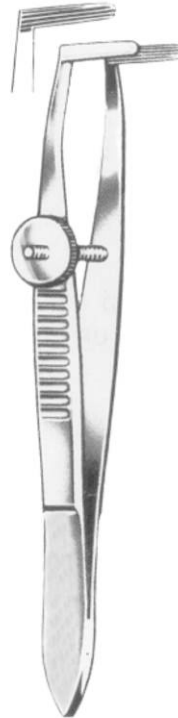

**Blascovics**  
BI 28-7776-09  
9 cm/3 1/2"



**Worth**  
BI 28-7777-10  
10 cm/4"

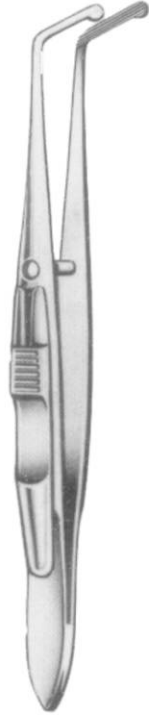

**Worth**  
BI 28-7778-10  
10 cm/4"



**Jameson**  
BI 28-7779-10  
10 cm/4"

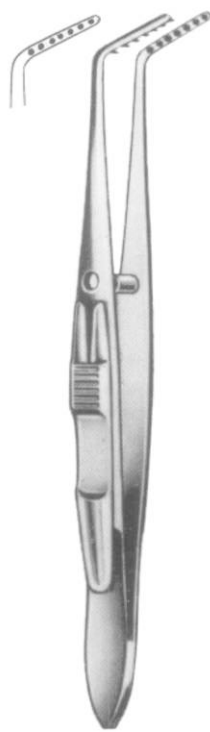

**Jameson**  
BI 28-7780-10  
10 cm/4"



**Prince**  
BI 28-7781-10  
10 cm/4"



**Prince**  
BI 28-7782-10  
10 cm/4"

OPHTHALMOLOGY



**Snellen**  
 BI 28-7783-10  
 10 cm/4"



**Snellen**  
 BI 28-7784-10  
 10 cm/4"



**Erhardt**  
 BI 28-7785-09  
 9 cm/3 1/2"

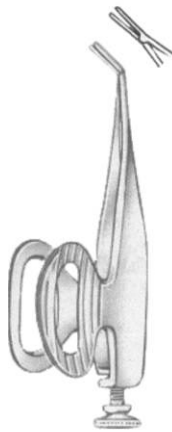

**Barraquer**  
 BI 28-7786-05  
 5.5 cm/2 1/4"

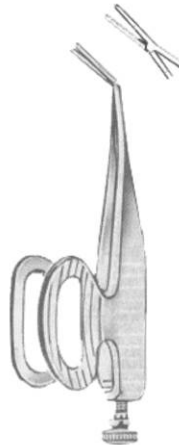

**Barraquer**  
 BI 28-7787-05  
 5.5 cm/2 1/4"



**Barraquer**  
 BI 28-7788-05  
 5.5 cm/2 1/4"





10 x

With guide pin

1:2  
**Bonn**  
BI 28-7789-07  
7 cm/2 3/4"



10 x

Without guide pin

1:2  
**Bonn**  
BI 28-7790-07  
7 cm/2 3/4"

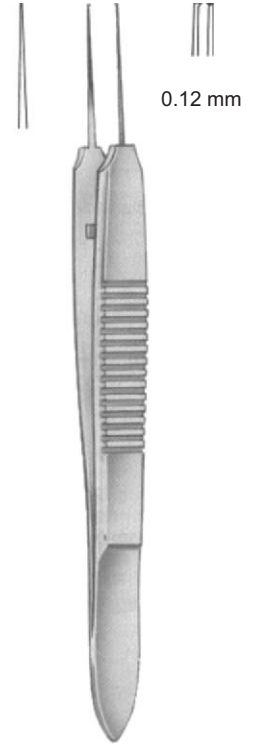

0.12 mm

**Bonn**  
BI 28-7791-10  
10 cm/4"



**Bishop-Harman**  
BI 28-7792-08  
8.5 cm/3 1/2"



**Bishop-Harman**  
BI 28-7793-08  
8.5 cm/3 1/2"



fine

**Bishop-Harman**  
BI 28-7794-08  
8.5 cm/3 1/2"



10 x  
fine

1:2  
**Bishop-Harman**  
BI 28-7795-08  
8.5 cm/3 1/2"



**Graefe**  
 10 cm/4"



BI 28-7796-10



BI 28-7797-10



BI 28-7798-10



BI 28-7799-10



BI 28-7800-10



BI 28-7801-10

Conjunctival forceps



**Stevens**  
 10.5 cm/4¼"



BI 28-7802-10



BI 28-7803-10



BI 28-7804-10



BI 28-7805-10



BI 28-7806-10



BI 28-7807-10



**O'Connor**  
 BI 28-7808-10  
 10 cm/4"



**Stevens**  
 BI 28-7809-11  
 11 cm/4½"



**Stevens**  
 BI 28-7810-11  
 11 cm/4"





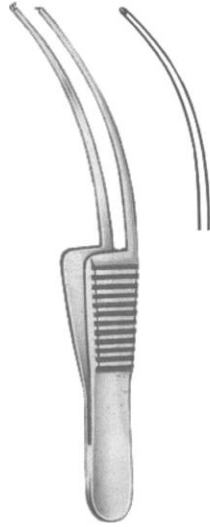

**Fischer**  
BI 28-7811-07  
7 cm/2 3/4"

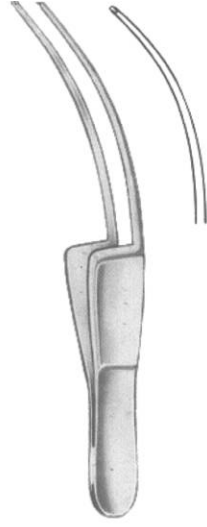

**Fischer-Arit**  
BI 28-7812-07  
7 cm/2 3/4"



**Hess**  
BI 28-7813-07  
7 cm/2 3/4"



**Hess**  
BI 28-7814-07  
7 cm/2 3/4"



**Bloth** BI 28-7815-01  
**Chandler** BI 28-7816-02  
 Serrated BI 28-7816-02



**Fuchs**  
BI 28-7817-07  
7 cm/2 3/4"



**Gill-Hess**  
BI 28-7818-07  
7.5 cm/3"



**Gill-Hess** BI 28-7819-07  
 Teeth Below BI 28-7820-07  
 Teeth on side

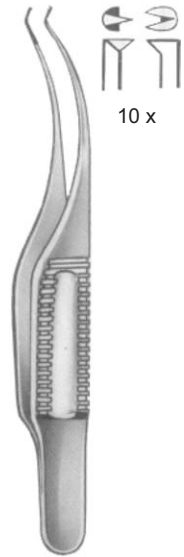

**Barraquer-Katzin**  
(Colibri)  
BI 28-7821-07  
7 cm/2 3/4"



10 x





**Fuchs**  
 BI 28-7822-07  
 7 cm/2 ¾"

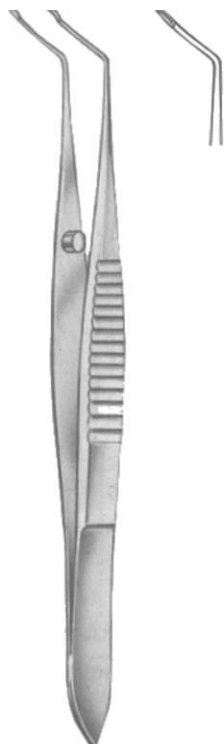

**Kalt**  
 BI 28-7823-10  
 10 cm/4"



**Terson**  
 BI 28-7824-09  
 9.5 cm/3 ¾"



**Arruga-Nizetic**  
 BI 28-7825-10  
 10 cm/4"



**Castroviejo**  
 BI 28-7826-10  
 10 cm/4"



**Castroviejo**  
 BI 28-7827-10  
 10 cm/4"



**Elschnig**  
 BI 28-7828-10  
 10 cm/4"

For Len Implantation



**Binkhorst**  
 BI 28-7829-07  
 7 cm/2 ¾"



**Arruga**  
 BI 28-7830-09  
 9.5 cm/3 ¾"



**Arruga**  
 BI 28-7831-09  
 9.5 cm/3 ¾"





**Knapp**  
BI 28-7832-11  
11 cm/4¼"



**Ayer**  
BI 28-7833-09  
9 cm/3½"



**Ayer**  
BI 28-7834-09  
9 cm/3½"



**Lambert**  
BI 28-7835-09  
9 cm/3½"



**DeBlarres**  
9 cm/3½"



BI 28-7836-01



BI 28-7837-02



BI 28-7838-03



Fig. 1

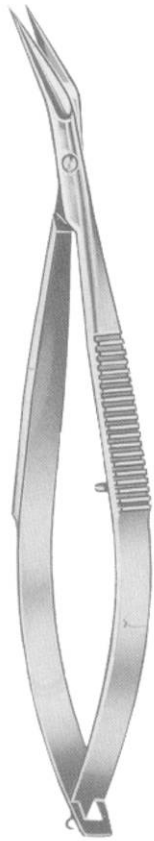

Fig. 2



Fig. 3

**Noyes**  
 Fig.1 BI 28-7839-01  
 Fig.2 BI 28-7839-02  
 Fig.3 BI 28-7839-03  
 12 cm/4 3/4"



**Noyes**  
 BI 28-7840-12  
 12 cm/4 3/4"



BI 28-7841-01

BI 28-7842-02

**Wecker**  
 11.5 cm/4 1/2"



**Barraquer**  
 BI 28-7843-05  
 5.5 cm/2 1/4"

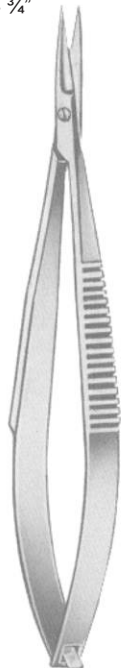

BI 28-7844-09  
 9 cm/3 1/2"



BI 28-7845-09



BI 28-7846-09



BI 28-7847-09



BI 28-7848-09



BI 28-7849-09



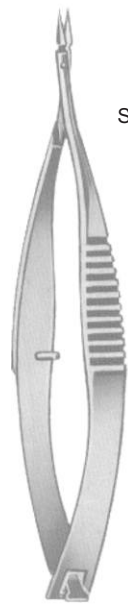

Straight

**Vannas**  
BI 28-7850-08  
8 cm/3 1/4"

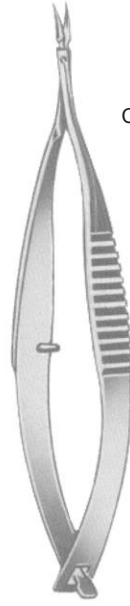

Curved

**Vannas**  
BI 28-7851-08  
8 cm/3 1/4"

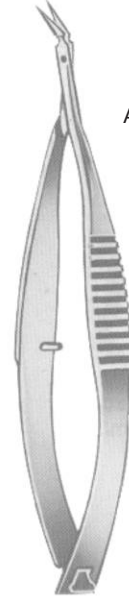

Angular

**Vannas**  
BI 28-7852-08  
8 cm/3 1/4"

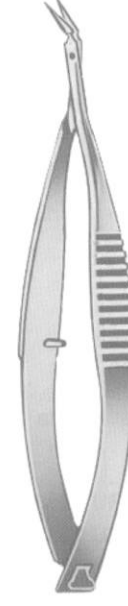

**Vannas**  
BI 28-7853-08  
8 cm/3 1/4"



Straight

BI 28-7854-08  
8.5 cm/3 1/4"

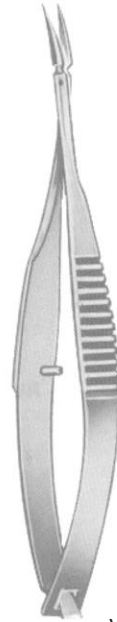

Curved

**Vannas Mod, Tubingen**  
BI 28-7855-08  
8.5 cm/3 1/4"

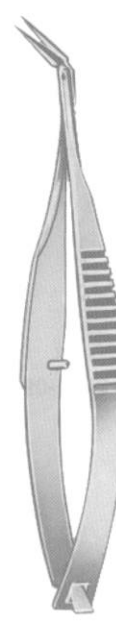

Angular

BI 28-7856-08  
8.5 cm/3 1/4"

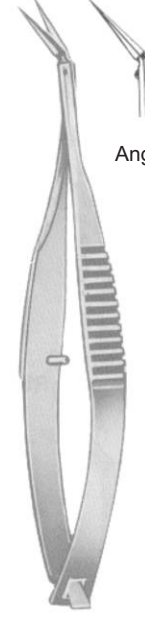

Angular

BI 28-7857-08  
8.5 cm/3 1/4"

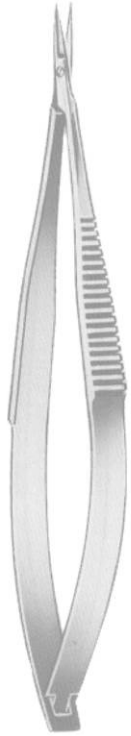

BI 28-7858-10  
 10 cm/4"



BI 28-7859-10  
 10 cm/4"



**Castroviejo**  
 BI 28-7860-10  
 10 cm/4"



**Castroviejo**  
 BI 28-7861-10  
 10 cm/4"



**Aebli**  
 BI 28-7862-10  
 10 cm/4"

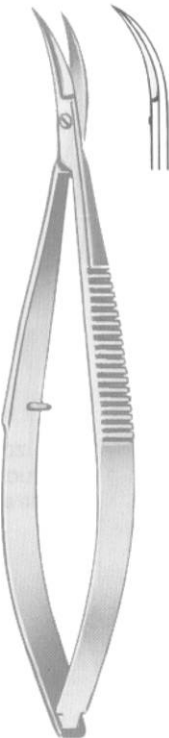

**Castroviejo**  
 BI 28-7863-10  
 10 cm/4"

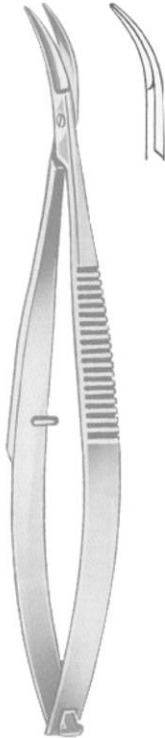

**Castroviejo**  
 BI 28-7864-10  
 10 cm/4"

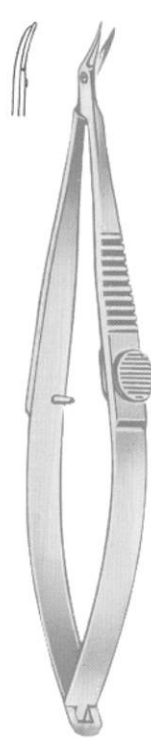

**Troutman-Barraquer**  
 BI 28-7865-10  
 10 cm/4"

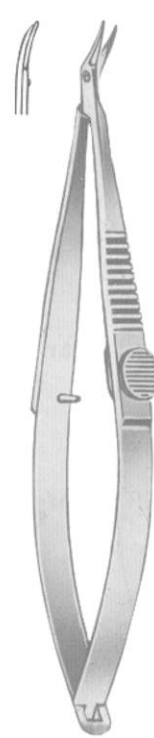

**Troutman-Barraquer**  
 BI 28-7866-10  
 10 cm/4"



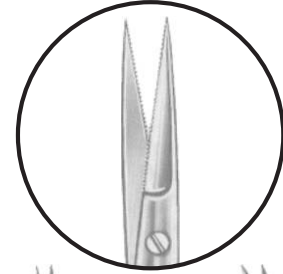

Saw Edge

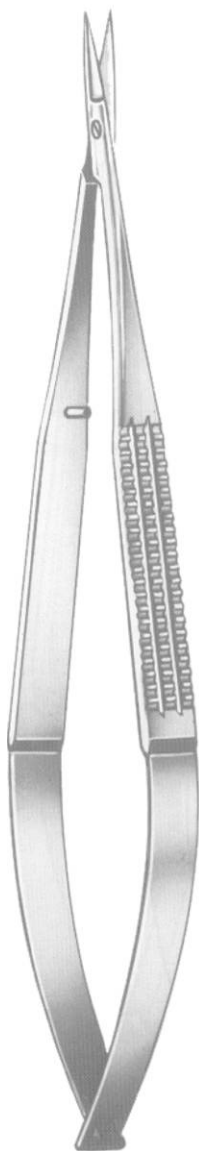

Straight  
BI 28-7867-16  
16cm/6 1/4"

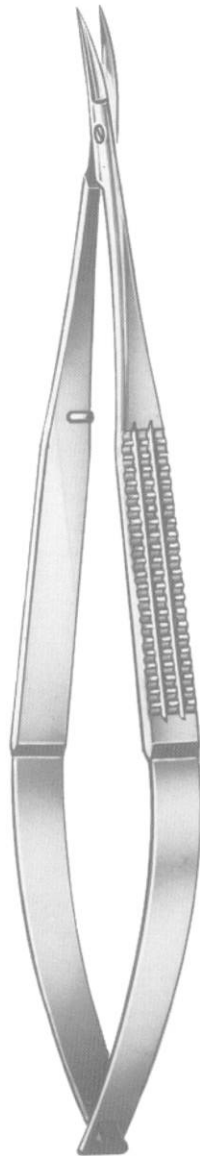

Curved  
BI 28-7868-16  
16cm/6 1/4"

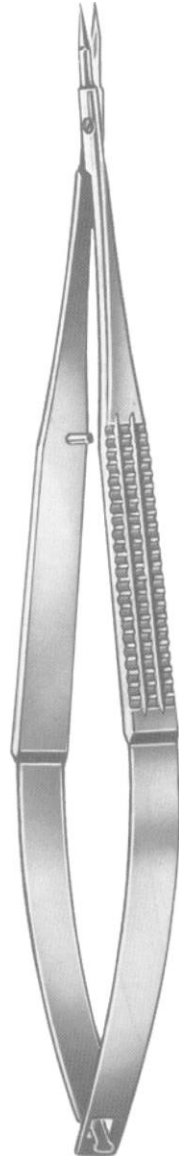

Straight  
BI 28-7869-16  
16cm/6 1/4"

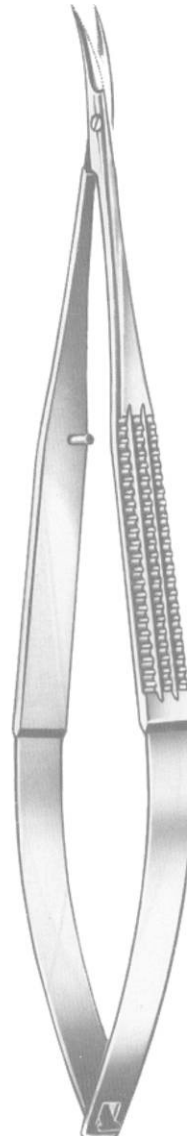

Curved  
BI 28-7870-16  
16cm/6 1/4"

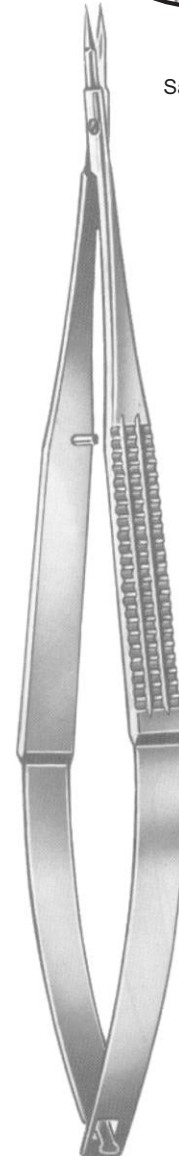

**Millesi**  
Straight  
BI 28-7871-16  
16cm/6 1/4"

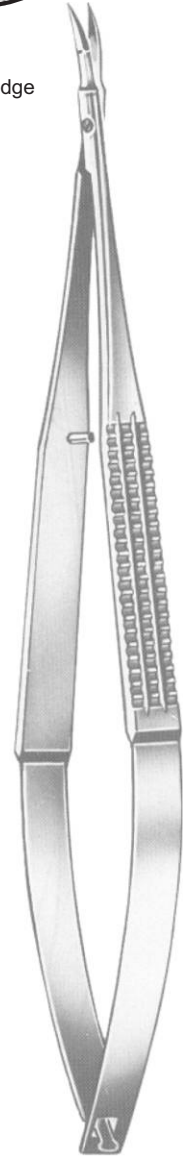

**Millesi**  
Curved  
BI 28-7872-16  
16cm/6 1/4"





Straight  
 BI 28-7873-18  
 18.5cm/7 ¼"

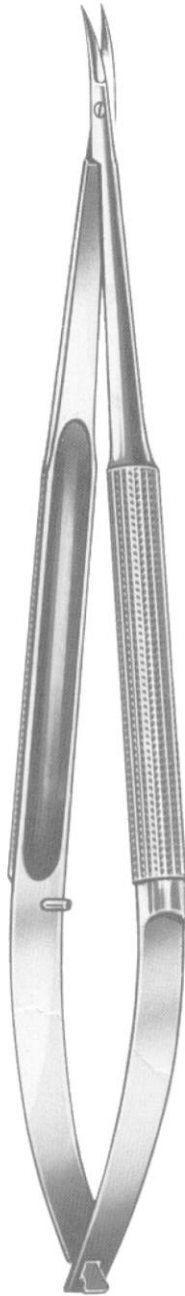

Curved  
 BI 28-7874-18  
 18.5cm/7 ¼"

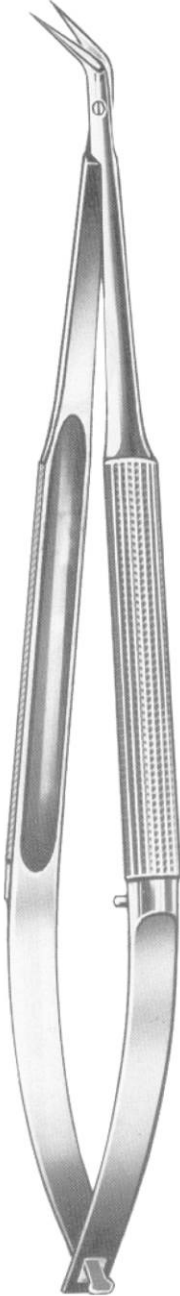

Angular  
 BI 28-7875-18  
 18.5cm/7 ¼"



Straight  
 BI 28-7876-23  
 23cm/9"



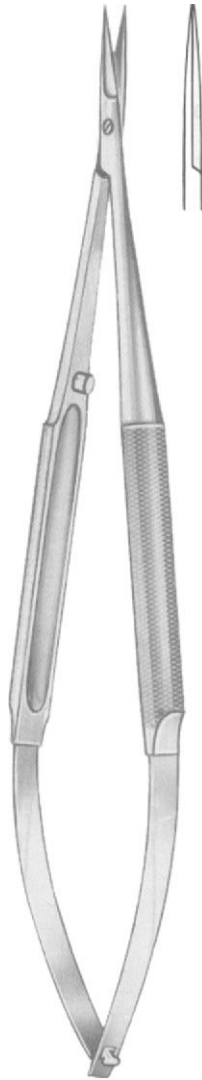

Straight  
BI 28-7877-14  
14.5cm/5 3/4"

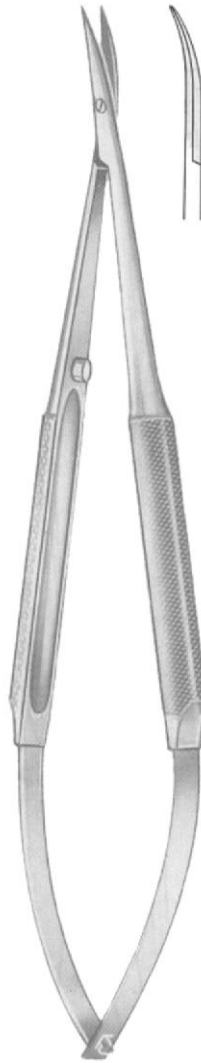

Curved  
BI 28-7878-14  
14.5cm/5 3/4"

Dissecting Scissors

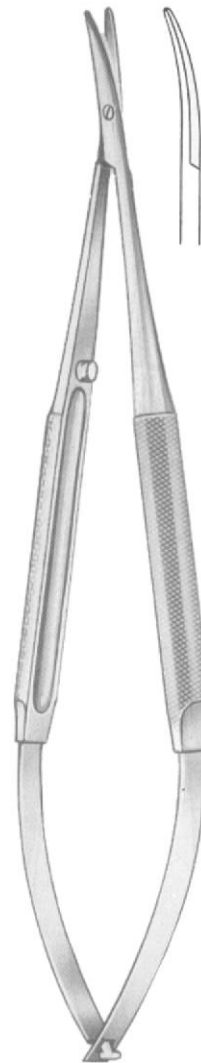

Curved  
BI 28-7879-14  
14.5cm/5 3/4"