

25

- EN** Kidney, Liver, Gall Stone, Urology
- DE** Niere, Leber, Galle, Urologie
- ES** Riñón, Hígado, Bilis, Urología
- FR** Rein, foie, calculs biliaires, urologie
- IT** Rene, fegato, calcoli biliari, urologia

Page 620 to 638





Guyon

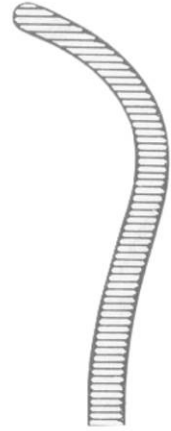

BI 25-7301-20
20 cm/8"

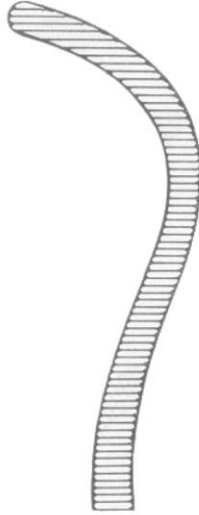

BI 25-7301-22
22 cm/8¾"

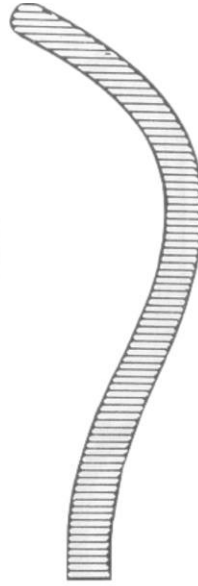

BI 25-7301-24
24 cm/9½"

Atrauma

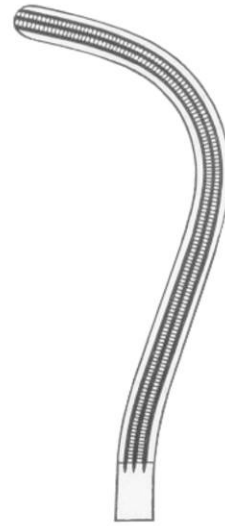

BI 25-7302-23
23 cm/9"

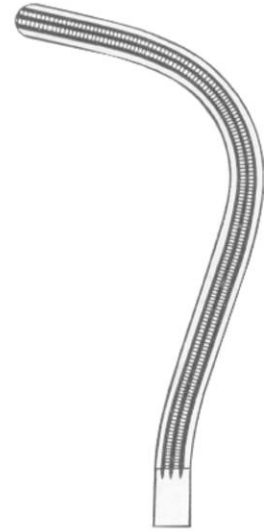

BI 25-7302-24
24 cm/9½"

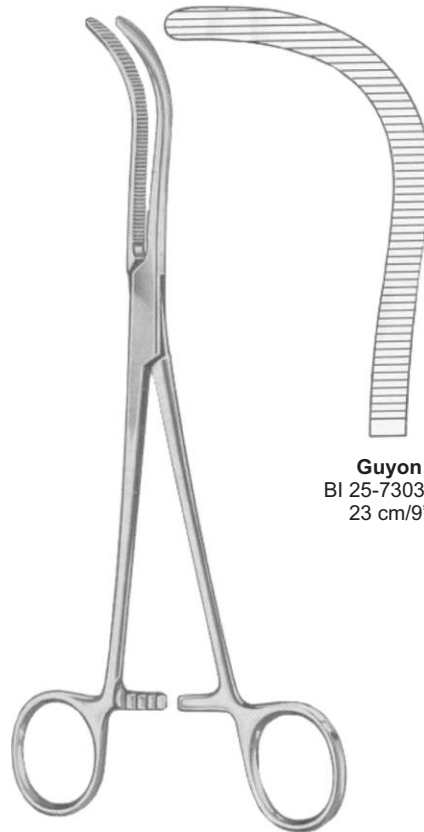

Guyon
BI 25-7303-23
23 cm/9"



KIDNEY, UROLOGY

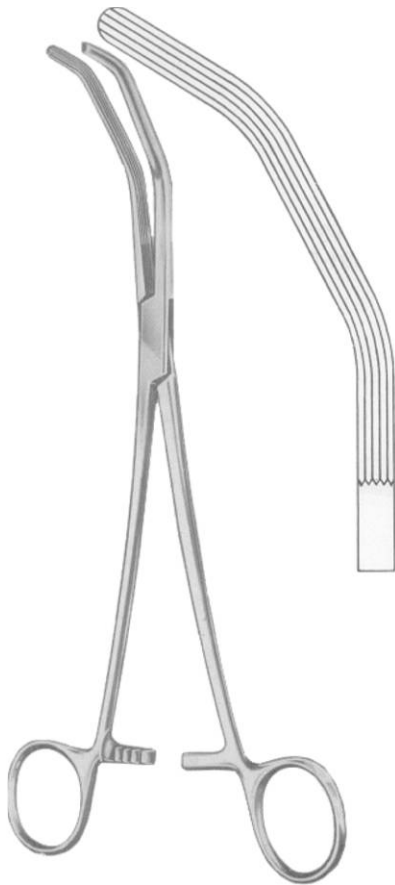

Herrick
 BI 25-7304-23
 23 cm/9"

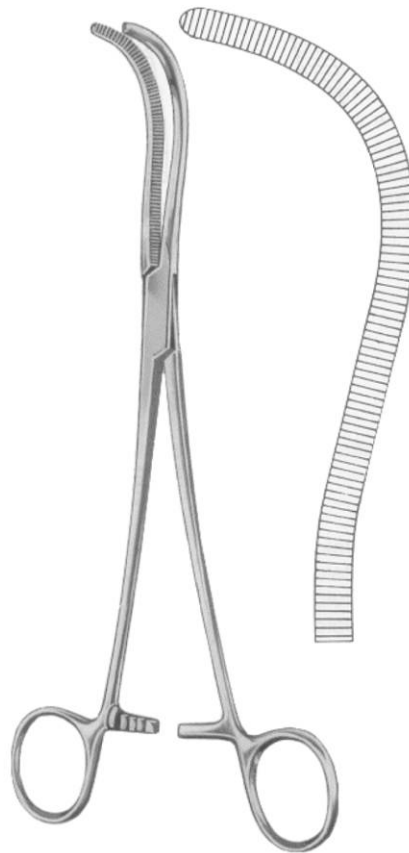

Mayo-Guyon
 BI 25-7305-23
 23 cm/9"

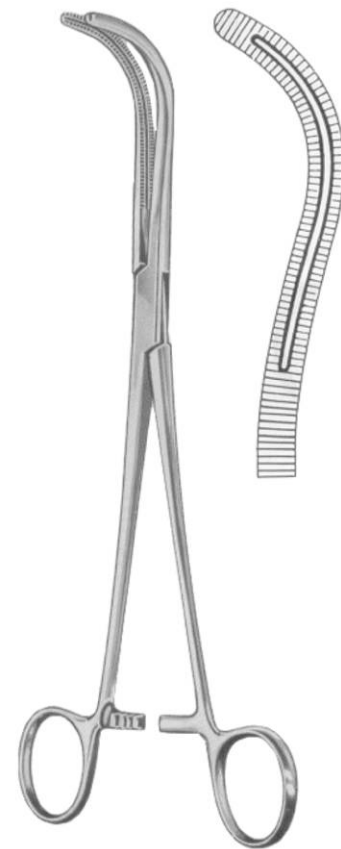

Stille
 BI 25-7306-23
 23 cm/9"



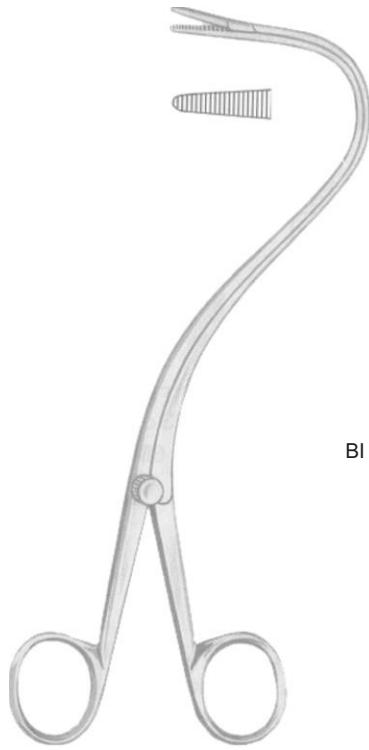

Elsasser
BI 25-7307-20
20 cm/8"

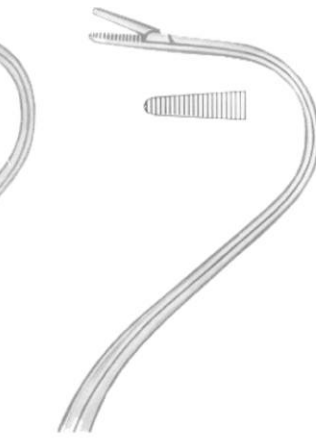

BI 25-7308-20
20 cm/8"

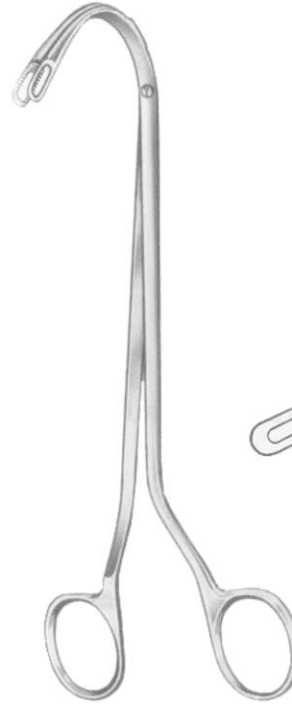

Randall

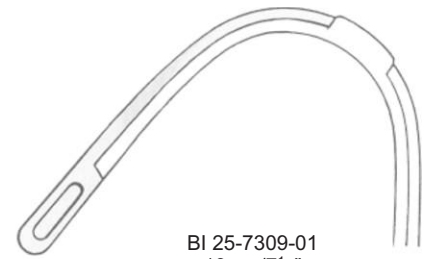

BI 25-7309-01
19 cm/7½"



BI 25-7309-02
19 cm/7½"



Randall

Fig. 4
BI 25-7310-04
22 cm/8¾"

Fig. 3
BI 25-7310-03
22 cm/8¾"

Fig. 2
BI 25-7310-02
22 cm/8¾"

Fig. 1
BI 25-7310-01
23 cm/9"

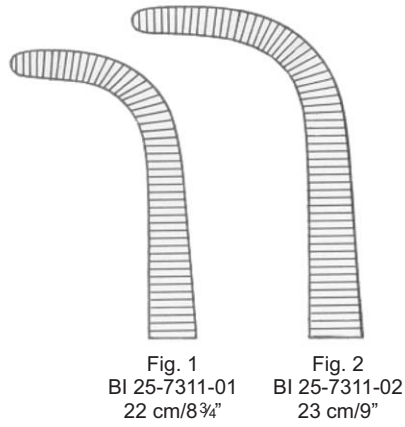
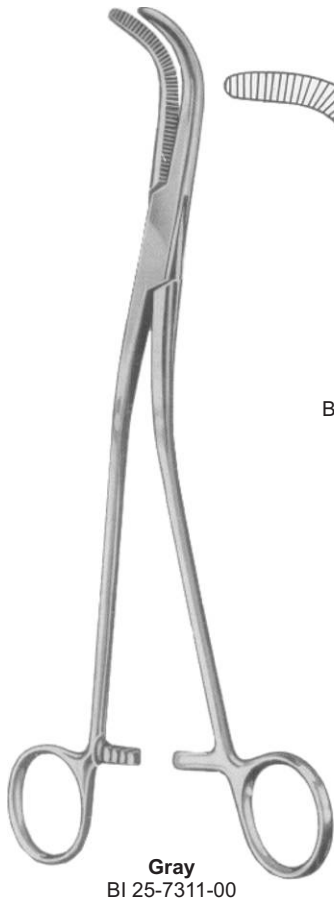

Set of 2 pieces

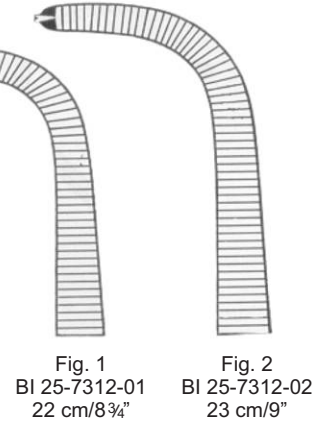
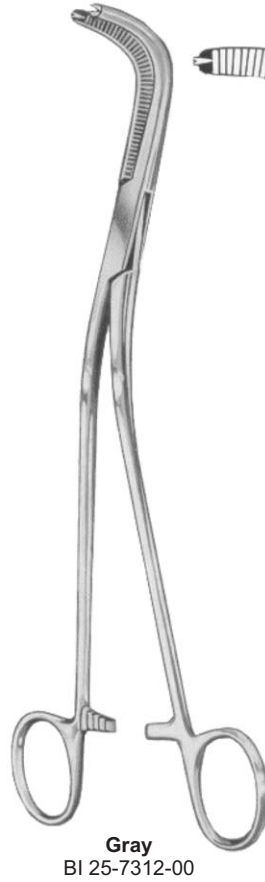

Set of 2 pieces

Gall duct and
 cystic forceps

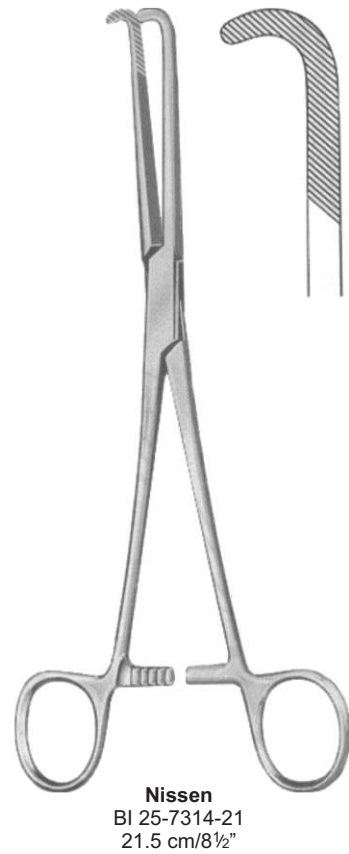
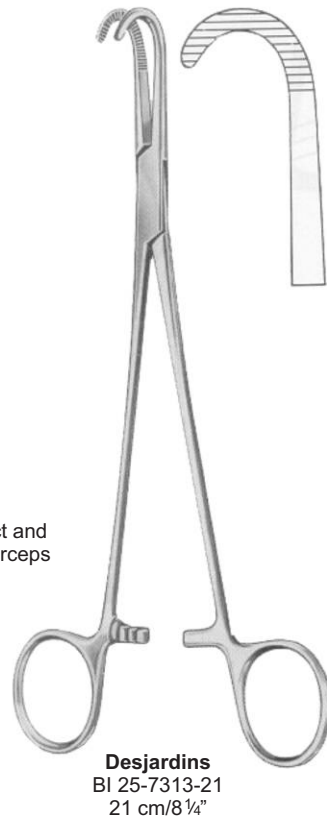

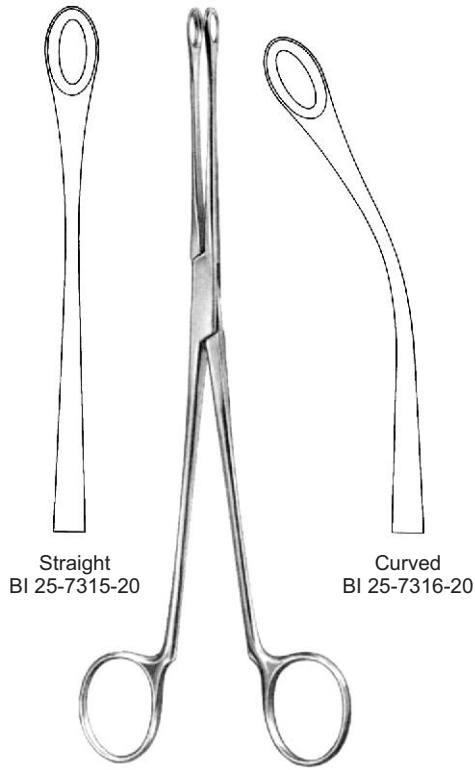

Straight
BI 25-7315-20

Curved
BI 25-7316-20

Blake
20 cm/8"



Straight
BI 25-7317-20

Mayo-Blake
20 cm/8"



Curved
BI 25-7318-20

Mayo-Blake
20 cm/8"



Czerny
BI 25-7319-24
24.5 cm/9¾"

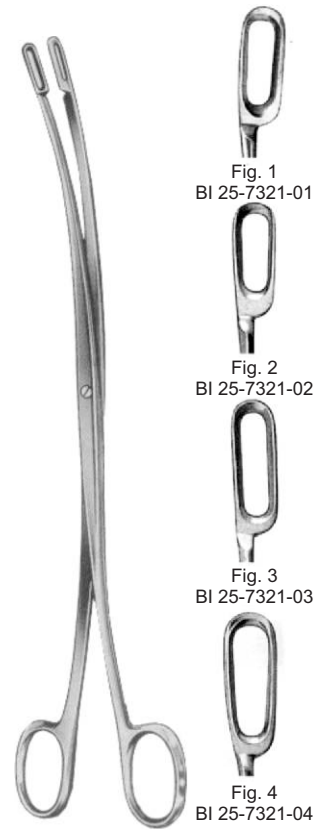

Desjardins
23 cm/9"

Fig. 1
BI 25-7321-01

Fig. 2
BI 25-7321-02

Fig. 3
BI 25-7321-03

Fig. 4
BI 25-7321-04

KIDNEY, UROLOGY

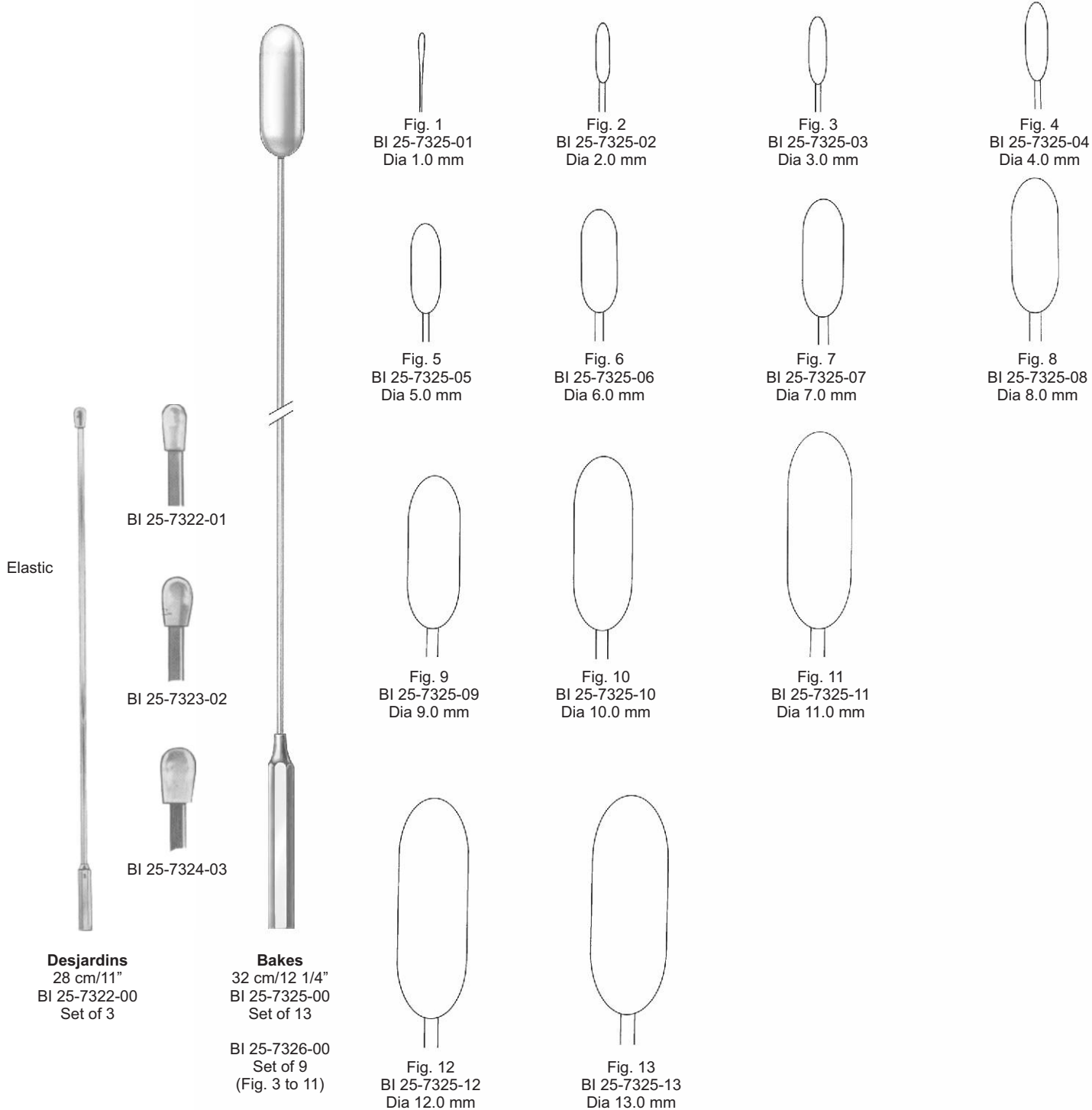



Elastic



Desjardins
30 cm/12"
BI 25-7327-00
Set of 4



Fig.1
BI 25-7327-01



Fig.2
BI 25-7327-02



Fig.3
BI 25-7327-03



Fig.4
BI 25-7327-04

Malleable



Luer-Koerte
32 cm/12½"
BI 25-7328-00
Set of 8



BI 25-7328-02
2.5 mm



BI 25-7328-03
3.2 mm



BI 25-7328-04
4.2 mm



BI 25-7328-05
5.5 mm

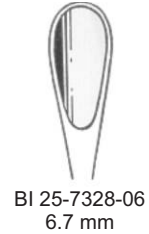

BI 25-7328-06
6.7 mm



BI 25-7328-08
8.0 mm

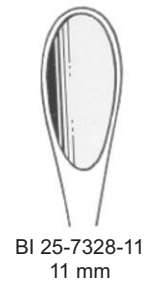

BI 25-7328-11
11 mm



BI 25-7328-15
15 mm

KIDNEY, UROLOGY

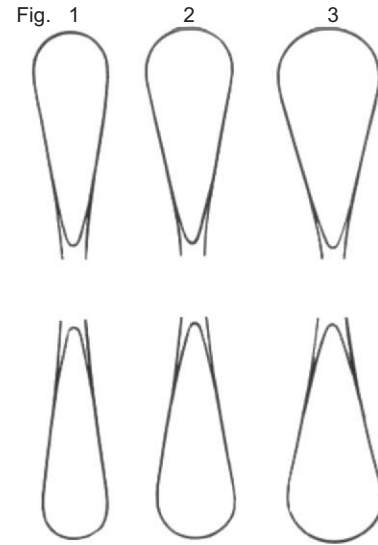
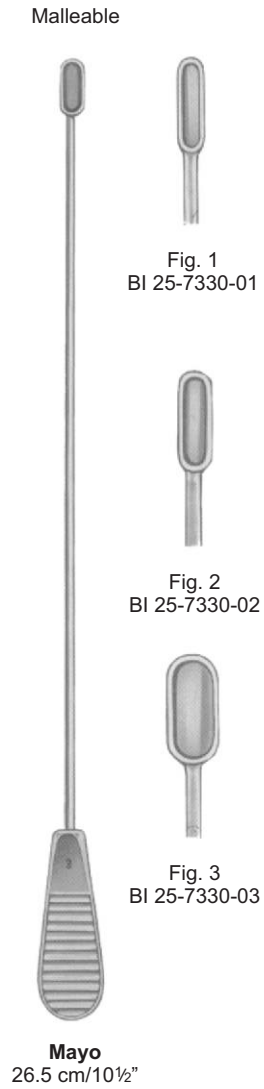

Fig.
 1 BI 25-7331-01
 2 BI 25-7331-02
 3 BI 25-7331-03





Young
BI 25-7332-22
22 cm/8¾"



Young
BI 25-7333-21
21 cm/8¼"



Young
BI 25-7334-22
22 cm/8¾"

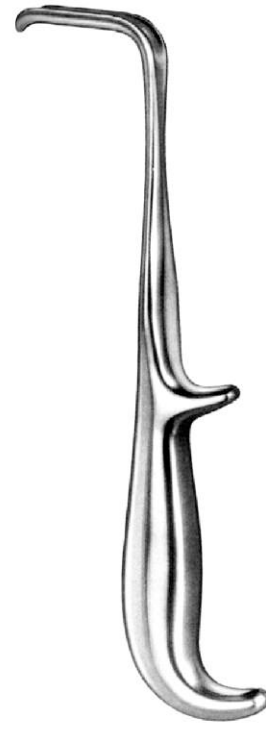

Young
BI 25-7335-21
21 cm/8¼"



MILLIN
BI 25-7336-01
24.5cm



BI 25-7336-02 23.5cm

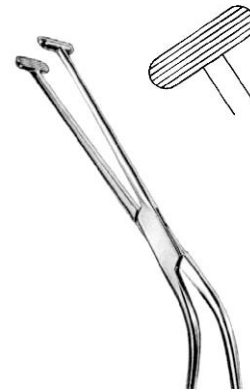

BI 25-7336-03 23.0cm

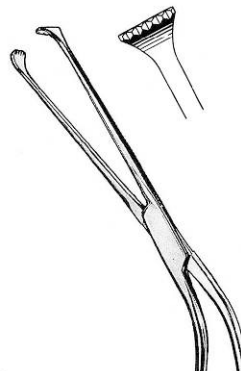

BI 25-7336-04 23.0cm

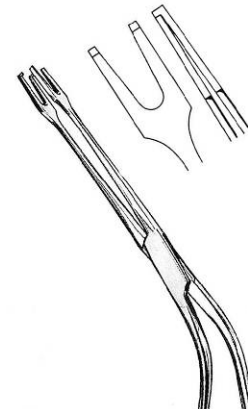

BI 25-7336-05 24.0cm

KIDNEY, UROLOGY

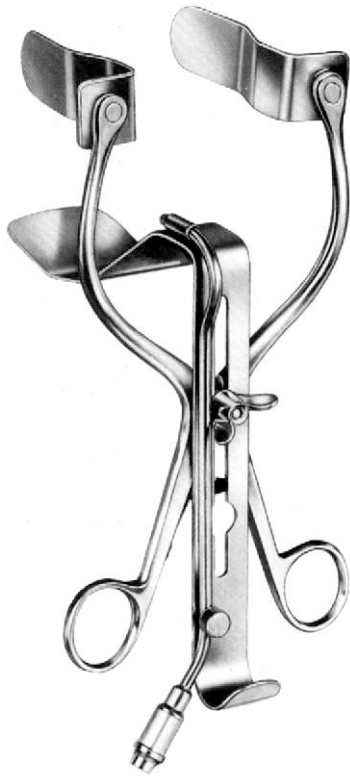

Millin
 BI 25-7339-00

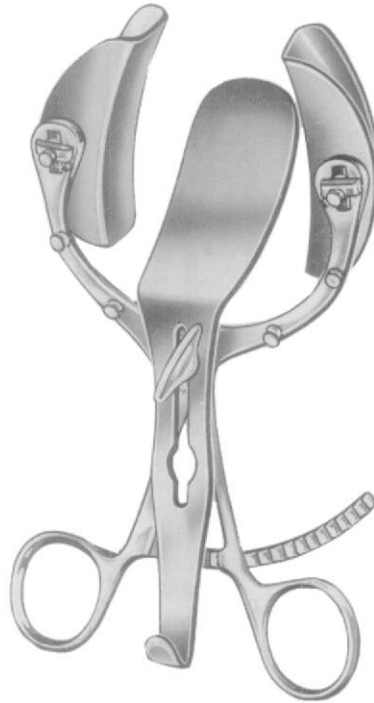

Legueu
 BI 25-7340-00

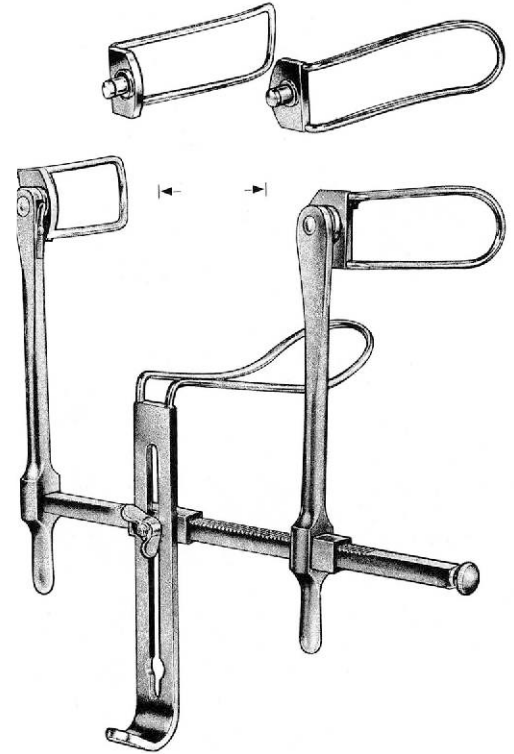

Gosset
 BI 25-7341-00

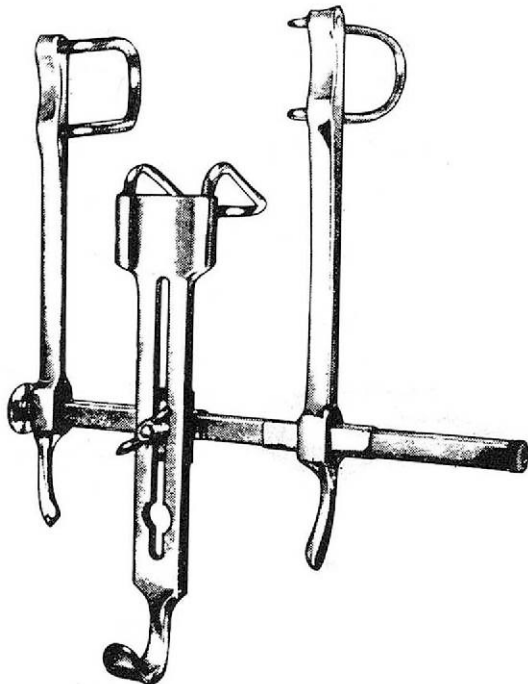

Pantings
 BI 25-7342-00

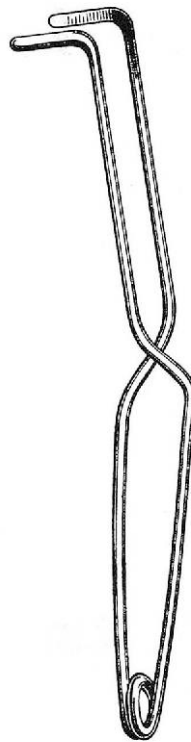

Millin
 BI 25-7342-01
 24 cm/9½"

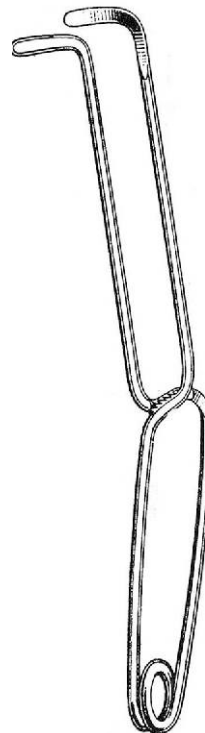

Millin
 BI 25-7342-02
 24 cm/9½"



Millin
 BI 25-7342-03
 24 cm/9½"



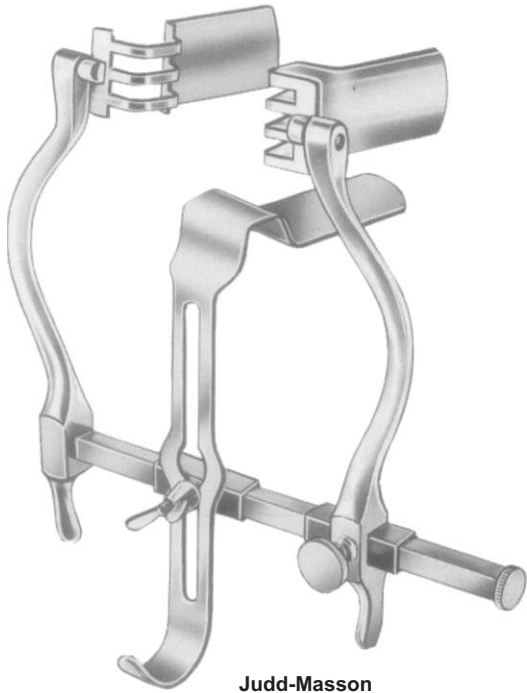

Judd-Masson
BI 25-7343-00

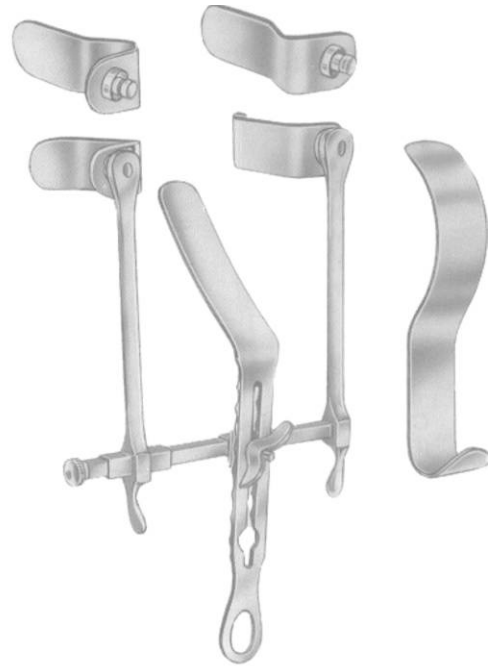

Thomson-Walker
BI 25-7344-00



Legueu
BI 25-7345-27
27 cm/10½"



Kocher
BI 25-7345-26
26 cm/10¼"

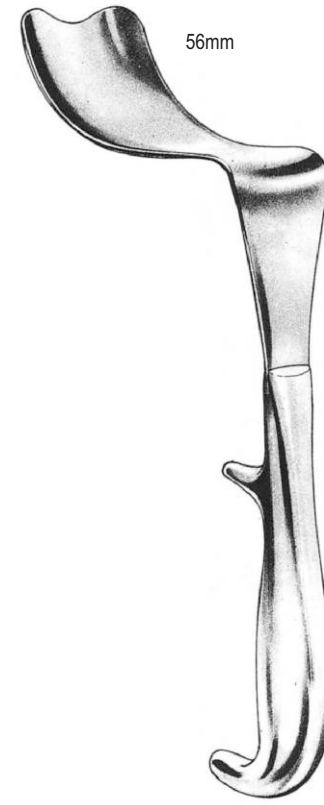

Kocher
BI 25-7346-26
26 cm/10¼"

Foreign Body Forceps ● EN
 Fremdkörperzangen ● DE
 Pinzas p/cuerpos extraños ● ES
 Forceps pour corps étrangers ● FR
 Pinze per corpi estranei ● IT

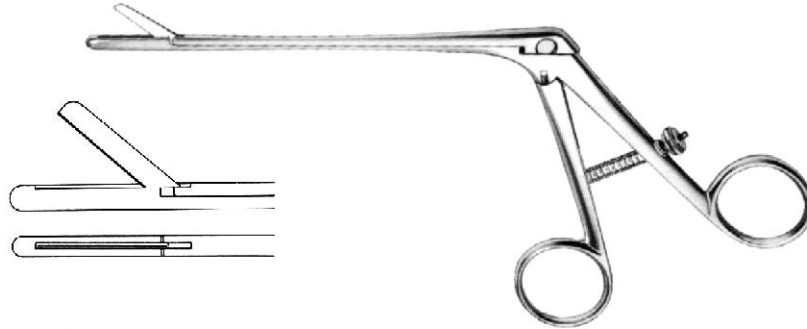

SACHSE
 BI 25-7347-12

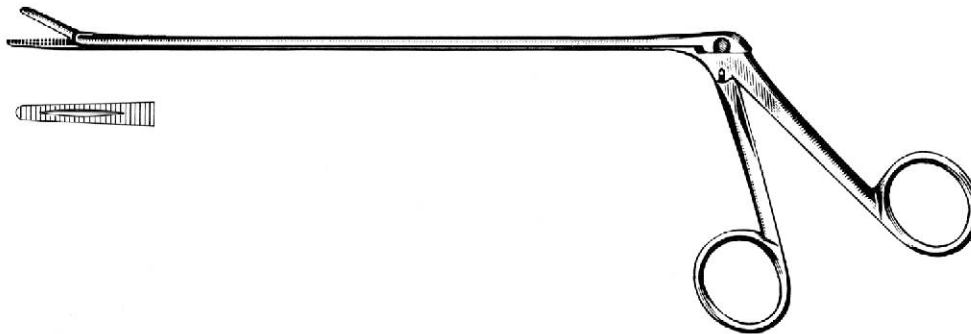

MATHIEU
 BI 25-7348-20 20.0cm
 BI 25-7348-28 28.0cm

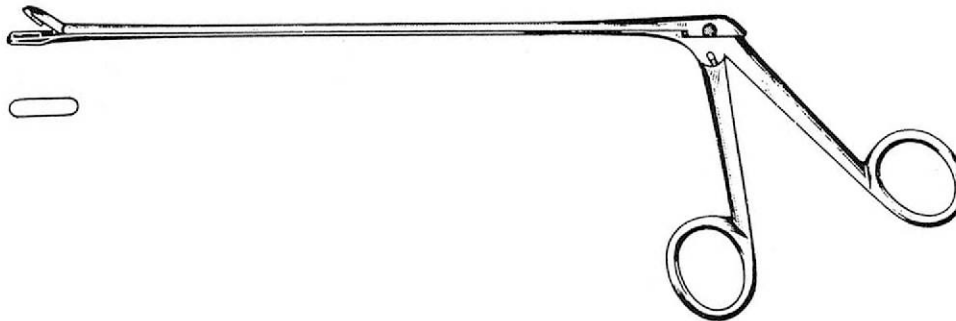

MATHIEU
 BI 25-7349-20 20.0cm
 BI 25-7349-28 28.0cm





STOCKMANN
BI 25-7350-08



ZIESER MEAEUS CLAMP
BI 25-7351-10
10.0cm



STRAUSS
BI 25-7352-11

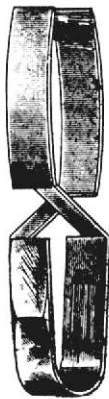

THOMSON-WALKER
BI 25-7353-00



LEWKOWITZ
BI 25-7354-26
26.0cm



BI 25-7355-26

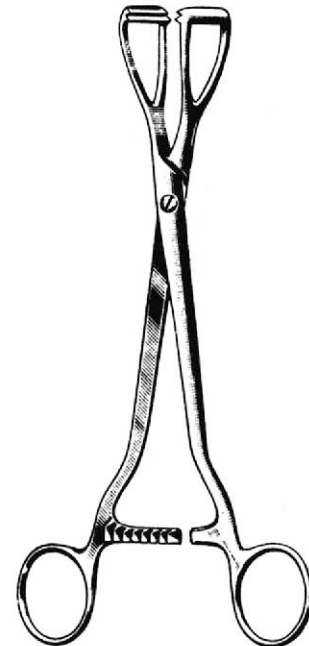

YOUNG
BI 25-7356-20
20.0cm

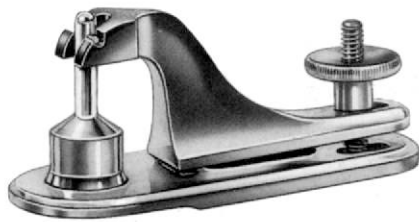
**GAMCO**

- BI 25-7357-08 8mm Ø, baby size
- BI 25-7357-11 11mm Ø, child size
- BI 25-7357-13 13mm Ø, child size
- BI 25-7357-16 16mm Ø, adolescent size
- BI 25-7357-21 21mm Ø, adolescent size
- BI 25-7357-26 26mm Ø, men's size
- BI 25-7357-32 32mm Ø, men's size

**WINKELMANN**

- BI 25-7358-12 12mm Ø
- BI 25-7358-16 16mm Ø
- BI 25-7358-20 20mm Ø

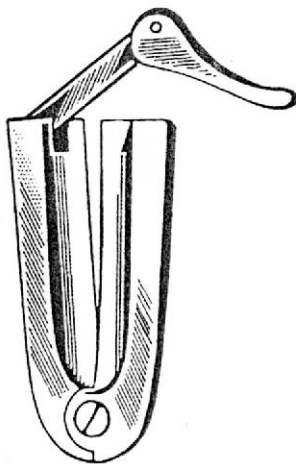
**MOGEN**

- BI 25-7359-00
- 58.0162.00

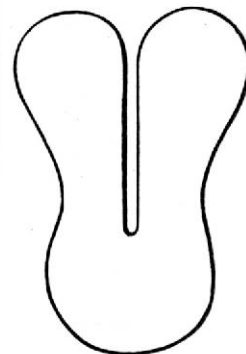
**CIRCUMCISION SHIELD**

- BI 25-7360-10
- 10.0cm

**CIRCUMCISION PROBE**

- BI 25-7361-15
- 15.0cm





CHILD
BI 25-7362-00



KEY
BI 25-7363-00

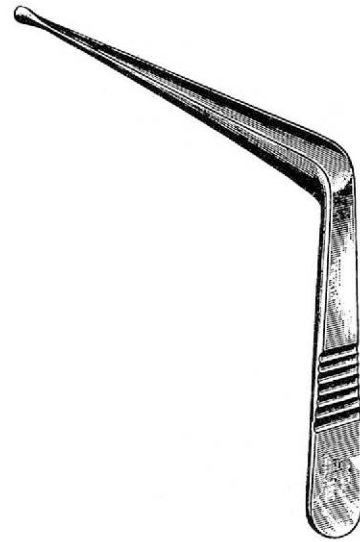

TEALE
BI 25-7364-00

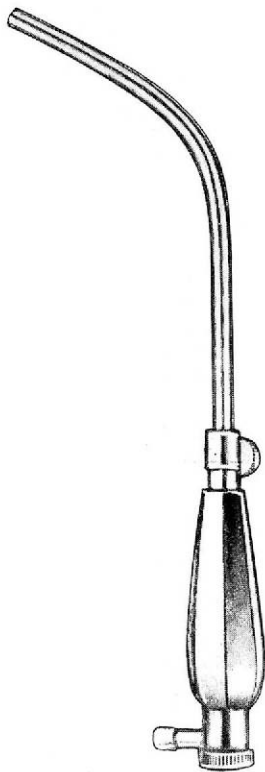

MILLIN
BI 25-7365-00



CORD HOOK
BI 25-7366-16
16.0cm



GUTTMANN
BI 25-7367-26
26.0cm



COXETER

F.G.	MALE 27.0cm	28.0cm
6	BI 25-7368-06	BI 25-7369-06
8	BI 25-7368-08	BI 25-7369-08
10	BI 25-7368-10	BI 25-7369-10
12	BI 25-7368-12	BI 25-7369-12
14	BI 25-7368-14	BI 25-7369-14
16	BI 25-7368-16	BI 25-7369-16
18	BI 25-7368-18	BI 25-7369-18
20	BI 25-7368-20	BI 25-7369-20
22	BI 25-7368-22	BI 25-7369-22
24	BI 25-7368-24	BI 25-7369-24



FEMALE 15.0cm	
6	BI 25-7370-06
8	BI 25-7370-08
10	BI 25-7370-10
12	BI 25-7370-12
14	BI 25-7370-14
16	BI 25-7370-16
18	BI 25-7370-18
20	BI 25-7370-20
22	BI 25-7370-22
24	BI 25-7370-24



MALE 20.0cm	
6	BI 25-7371-06
8	BI 25-7371-08
10	BI 25-7371-10
12	BI 25-7371-12
14	BI 25-7371-14
16	BI 25-7371-16
18	BI 25-7371-18
20	BI 25-7371-20
22	BI 25-7371-22
24	BI 25-7371-24

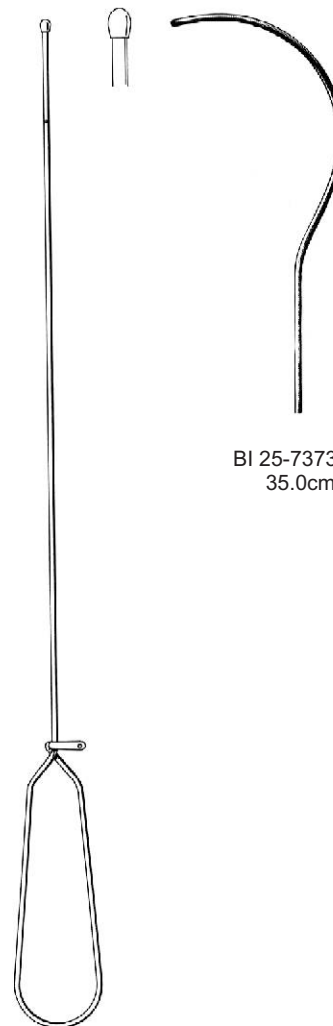

BI 25-7373-35
 35.0cm

BI 25-7372-39
 39.0cm



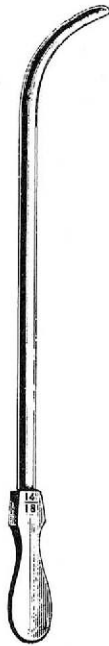

CLUTTON

set	BI 25-7374-00
F.G.	
06/10	BI 25-7374-06
08/12	BI 25-7374-08
10/14	BI 25-7374-10
12/16	BI 25-7374-12
14/18	BI 25-7374-14
16/20	BI 25-7374-16
18/22	BI 25-7374-18
20/24	BI 25-7374-20
22/26	BI 25-7374-22
24/28	BI 25-7374-24
26/30	BI 25-7374-26
28/32	BI 25-7374-28



LISTER

set	BI 25-7375-00
F.G.	
00/1	BI 25-7375-01
0/2	BI 25-7375-02
1/3	BI 25-7375-03
1/4	BI 25-7375-04
2/5	BI 25-7375-05
3/6	BI 25-7375-06
4/7	BI 25-7375-07
5/8	BI 25-7375-08
6/9	BI 25-7375-09
7/10	BI 25-7375-10
8/11	BI 25-7375-11
9/12	BI 25-7375-12
10/13	BI 25-7375-13
11/14	BI 25-7375-14
12/15	BI 25-7375-15
13/16	BI 25-7375-16
14/17	BI 25-7375-17
15/18	BI 25-7375-18



F.G.

06	BI 25-7376-06
08	BI 25-7376-08
10	BI 25-7376-10
12	BI 25-7376-12
14	BI 25-7376-14
16	BI 25-7376-16



WHEELHOUSE

BI 25-7377-00



	VAN BUREN	GUYON	GUYON	DITTEL	DITTEL
	BI 25-7378-00	BI 25-7379-00	BI 25-7380-00	BI 25-7381-00	BI 25-7382-00
	set No. 8-36	set No. 10-30	set No. 10-30	set No.10-30	set No.8-30
(French)					
8	BI 25-7378-08				BI 25-7382-08
9					BI 25-7382-09
10	BI 25-7378-10	BI 25-7379-10	BI 25-7380-10	BI 25-7381-10	BI 25-7382-10
11		BI 25-7379-11	BI 25-7380-11	BI 25-7381-11	BI 25-7382-11
12	BI 25-7378-12	BI 25-7379-12	BI 25-7380-12	BI 25-7381-12	BI 25-7382-12
13		BI 25-7379-13	BI 25-7380-13	BI 25-7381-13	BI 25-7382-13
14	BI 25-7378-14	BI 25-7379-14	BI 25-7380-14	BI 25-7381-14	BI 25-7382-14
15		BI 25-7379-15	BI 25-7380-15	BI 25-7381-15	BI 25-7382-15
16	BI 25-7378-16	BI 25-7379-16	BI 25-7380-16	BI 25-7381-16	BI 25-7382-16
17		BI 25-7379-17	BI 25-7380-17	BI 25-7381-17	BI 25-7382-17
18	BI 25-7378-18	BI 25-7379-18	BI 25-7380-18	BI 25-7381-18	BI 25-7382-18
19		BI 25-7379-19	BI 25-7380-19	BI 25-7381-19	BI 25-7382-19
20	BI 25-7378-20	BI 25-7379-20	BI 25-7380-20	BI 25-7381-20	BI 25-7382-20
21		BI 25-7379-21	BI 25-7380-21	BI 25-7381-21	BI 25-7382-21
22	BI 25-7378-22	BI 25-7379-22	BI 25-7380-22	BI 25-7381-22	BI 25-7382-22
23		BI 25-7379-23	BI 25-7380-23	BI 25-7381-23	BI 25-7382-23
24	BI 25-7378-24	BI 25-7379-24	BI 25-7380-24	BI 25-7381-24	BI 25-7382-24
25		BI 25-7379-25	BI 25-7380-25	BI 25-7381-25	BI 25-7382-25
26	BI 25-7378-26	BI 25-7379-26	BI 25-7380-26	BI 25-7381-26	BI 25-7382-26
27		BI 25-7379-27	BI 25-7380-27	BI 25-7381-27	BI 25-7382-27
28	BI 25-7378-28	BI 25-7379-28	BI 25-7380-28	BI 25-7381-28	BI 25-7382-28
29		BI 25-7379-29	BI 25-7380-29	BI 25-7381-29	BI 25-7382-29
30	BI 25-7378-30	BI 25-7379-30	BI 25-7380-30	BI 25-7381-30	BI 25-7382-30
31	BI 25-7378-31				
32	BI 25-7378-32				
33	BI 25-7378-33				
34	BI 25-7378-34				
35	BI 25-7378-35				
36	BI 25-7378-36				



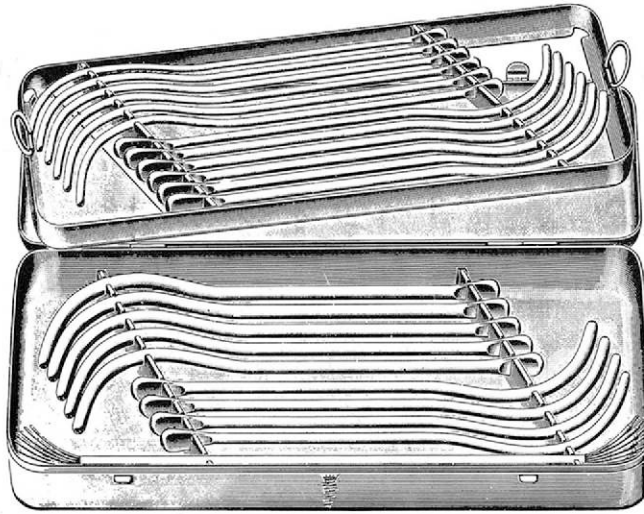

VAN BUREN
BI 25-7383-00
420x175x40 mm
set in metal case containing
21 bougies



GUYON
BI 25-7384-00
420x175x40mm
set in metal case containing
21 bougies
6 liliform in metal tube