

24

- EN** Stomach, Intestine, Rectum
- DE** Magen, Darm, Mastdarm
- ES** Estómago, Intestinos, Recto
- FR** Estomac, intestin, rectum
- IT** Stomaco, Intestino, Retto

Page 596 to 619

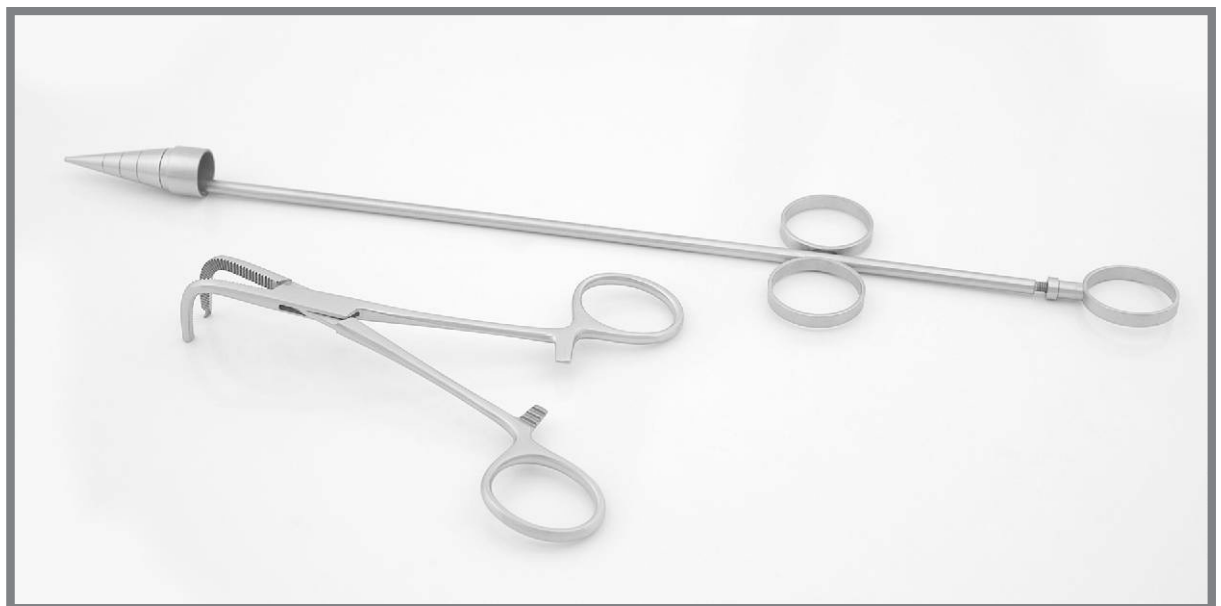



Allis

		4 : 5		5 : 6	
cm	in	BI 24-7101-15	BI 24-7102-15	BI 24-7101-19	BI 24-7102-19
15	6"				
19	7½"				
23	9"	BI 24-7101-23	BI 24-7102-23		
25	10"	BI 24-7101-25	BI 24-7102-25		



Baby-Allis

BI 24-7103-12	12 cm/4¾"
BI 24-7103-14	14 cm/5½"



Allis-Atrauma

BI 24-7104-16	16 cm/6¼"
BI 24-7104-20	20 cm/8"
BI 24-7104-25	25 cm/10"
BI 24-7104-30	30 cm/12"



Allis-Adair
 BI 24-7105-15
 15 cm/6"



Boys-Allis
 BI 24-7106-15
 15 cm/6"



Lockwood-Allis
 BI 24-7107-16 16 cm/6 ¼"
 BI 24-7107-20 20 cm/8"



Thoms-Allis
 BI 24-7108-20
 20 cm/8"

Tissue Seizing, Intestinal Atrauma Tissue Forceps
 Tissue Beschlagnahme, Darm Atrauma Tissue Zange
 Aprovechando el tejido intestinal y pinzas de tejido Atrauma
 Grippage de tissu, pince pour tissu d'atraumatiBle intestinal
 Pinze per il grippaggio dei tessuti, pinze per atraumi intestinali

- EN
- DE
- ES
- FR
- IT

STOMACH, INTESTINE & RECTUM

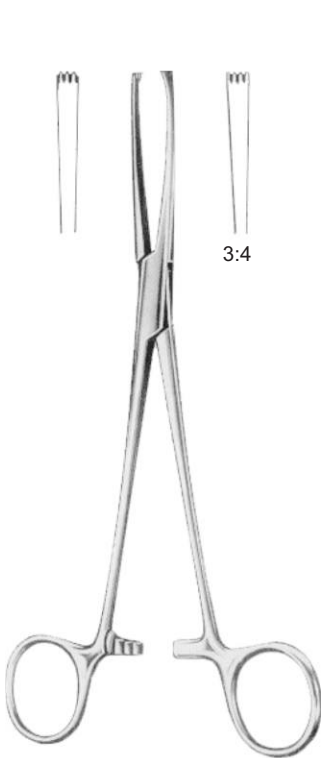

Judd-Allis
 BI 24-7109-15 15 cm/6"
 BI 24-7109-19 19 cm/7 1/2"



Littlewood
 BI 24-7110-18
 18.5 cm/7 1/4"

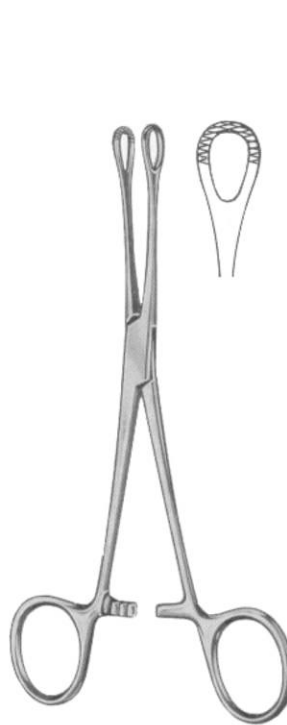

Williams
 BI 24-7111-16
 16 cm/6 1/4"



Lockwood
 BI 24-7112-20
 20 cm/8"

Atrauma



Babcock-Atrauma
 BI 24-7113-16
 BI 24-7113-20

cm/in
 16 cm/6 1/4"
 18 cm/7"
 20 cm/8"
 24 cm/9 1/2"



Babcock(Standard)
 BI 24-7114-16
 BI 24-7114-18
 BI 24-7114-20
 BI 24-7114-24



Baby-Babcock
 BI 24-7115-16



Babcock
 BI 24-7116-16
 BI 24-7116-18
 BI 24-7116-20
 BI 24-7116-24





Atrauma



BI 24-7117-18
18 cm/7"



BI 24-7117-20
20 cm/8"



BI 24-7117-23
23 cm/9"



Duval

	cm	in	
BI 24-7118-18	18	7"	BI 24-7119-18
BI 24-7118-20	20	8"	BI 24-7119-20
BI 24-7118-23	23	9"	BI 24-7119-23



Duval
BI 24-7120-20
20 cm/8"



TC



Child
BI 24-7121-24
24 cm/9½"



BI 24-7121-00
Pair

Atrauma



BI 24-7122-25
25 cm/10"



BI 24-7122-26
26 cm/10¼"

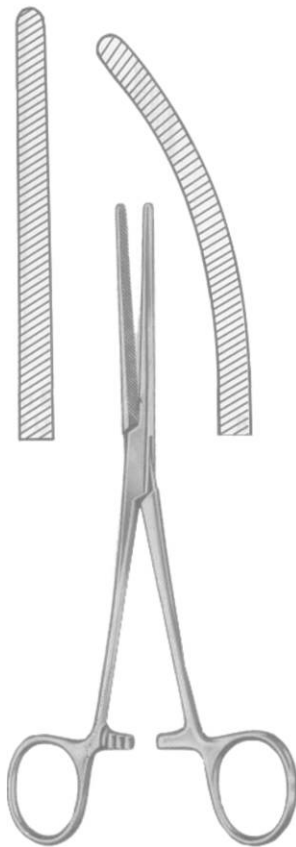

Baby-Doyen
 Straight BI 24-7123-18 18 cm/7"
 Curved BI 24-7124-18 18 cm/7"

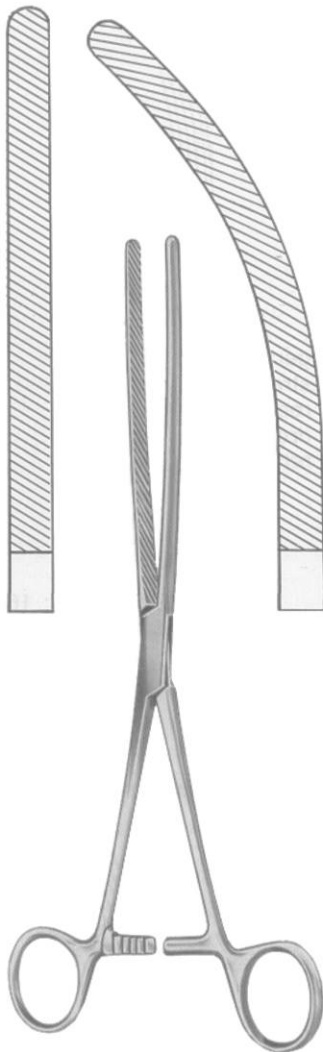

Doyen
 Straight BI 24-7125-21 21 cm/8 ¼ BI 24-7125-23 23 cm/9"
 Curved BI 24-7126-21 21 cm/8 ¼ BI 24-7126-23 23 cm/9"

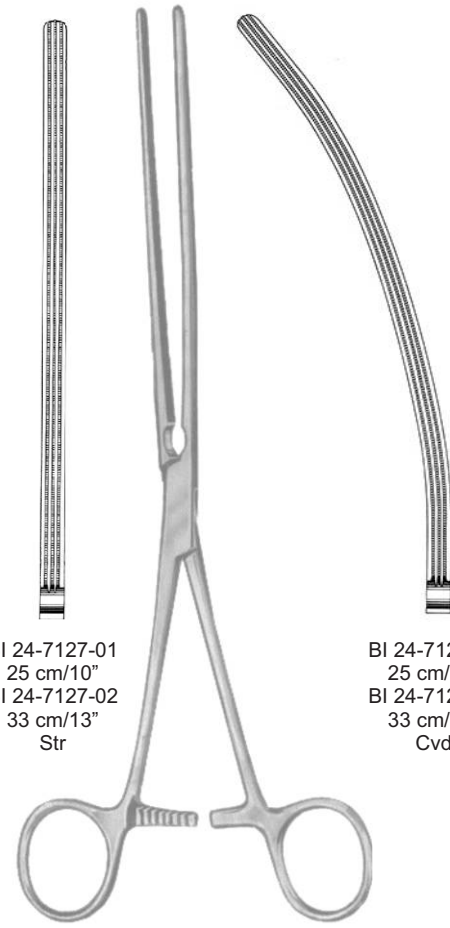

BI 24-7127-01 25 cm/10"
 BI 24-7127-02 33 cm/13"
 Str

BI 24-7127-03 25 cm/10"
 BI 24-7127-04 33 cm/13"
 Cvd

Scudder





Doyen-Atrauma

Atrauma

Straight

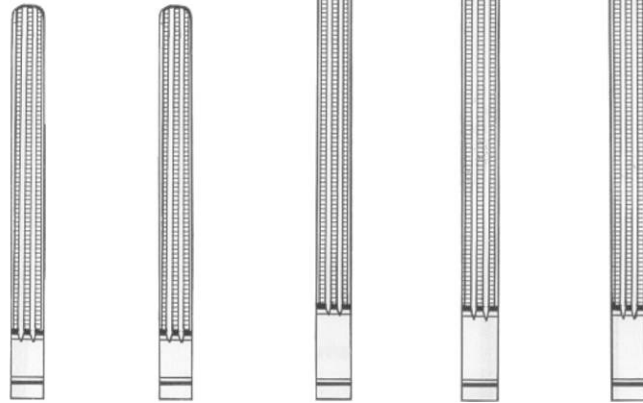

BI 24-7128-13 13 cm/5" BI 24-7128-16 16 cm/6¼" BI 24-7128-18 18 cm/7" BI 24-7128-21 21 cm/8¼" BI 24-7128-23 23 cm/9"

Curved

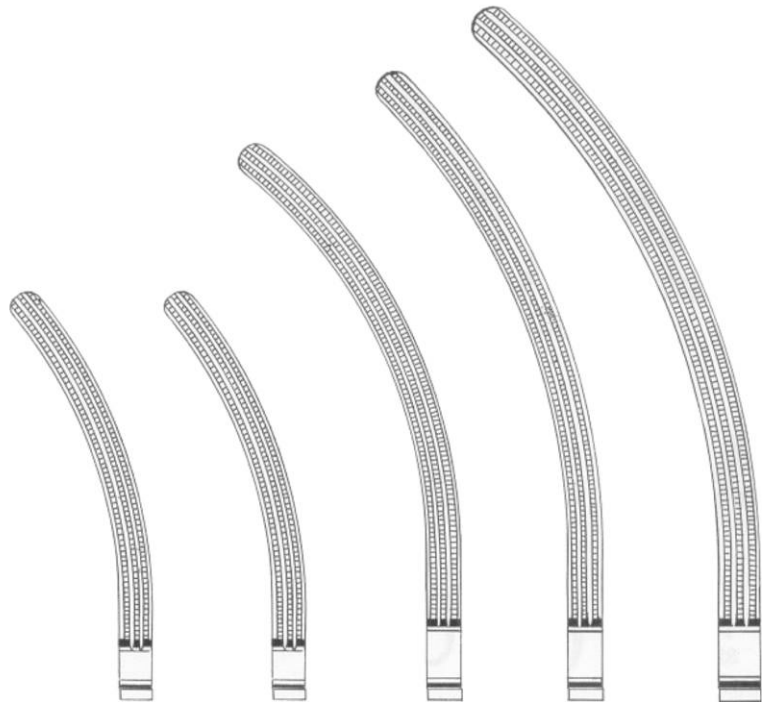

BI 24-7129-13 13 cm/5" BI 24-7129-16 16 cm/6¼" BI 24-7129-18 18 cm/7" BI 24-7129-21 21 cm/8¼" BI 24-7129-23 23 cm/9"

Atrauma



Mayo-Robson
Mayo-Robson Atrauma

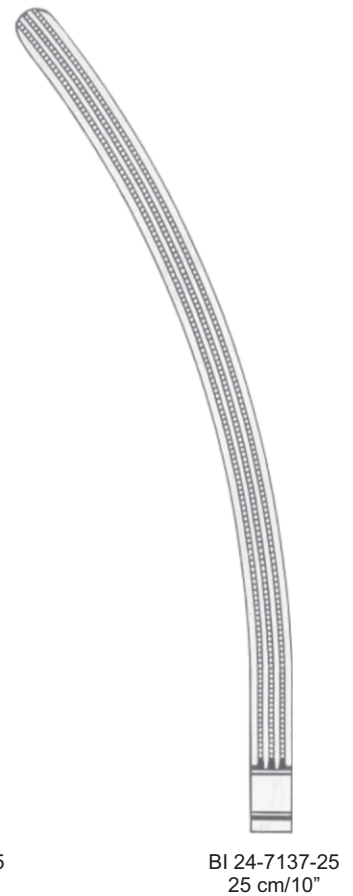
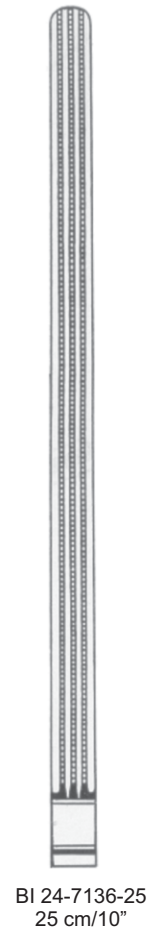
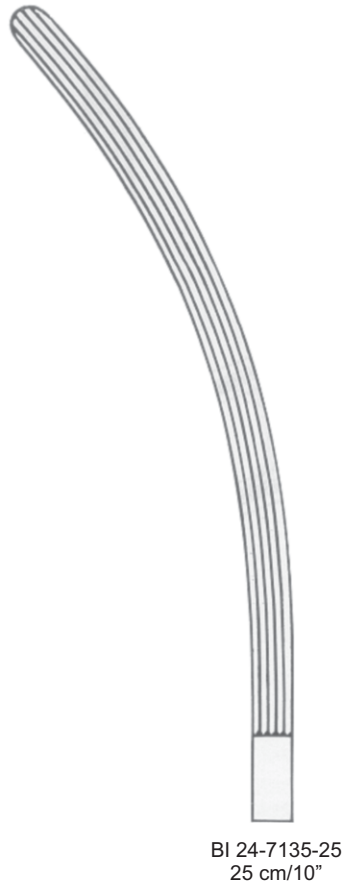
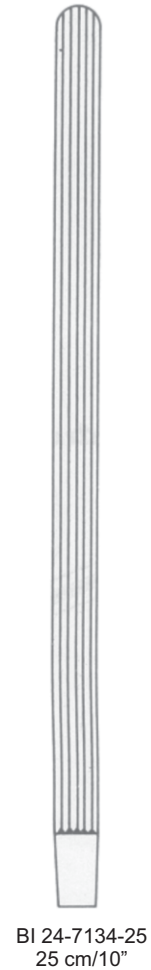
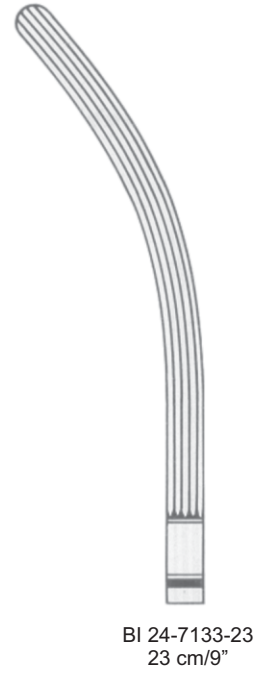
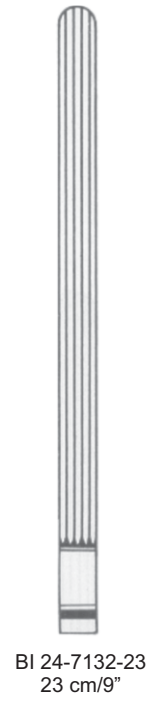
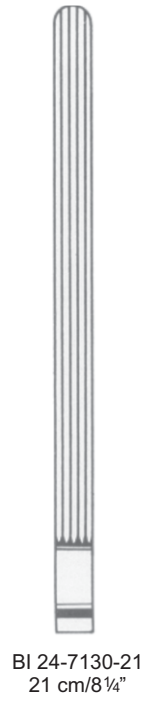

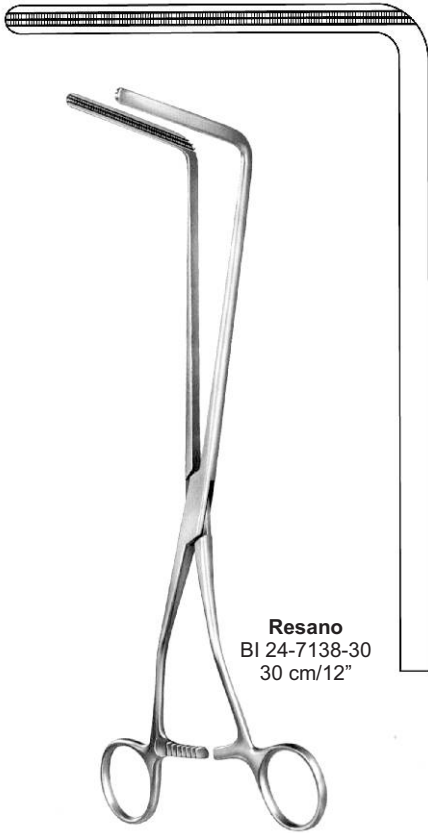

Resano
BI 24-7138-30
30 cm/12"



Hayes

Atrauma



BI 24-7139-26
26 cm/10 1/4"

BI 24-7140-28
28 cm/11"



Fehland
BI 24-7141-24
24 cm/9 1/2"

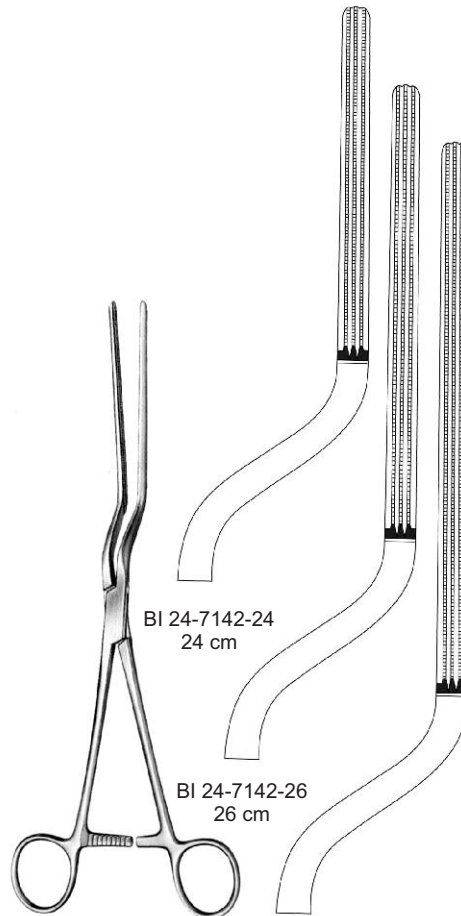

BI 24-7142-24
24 cm

BI 24-7142-26
26 cm

STOMACH, INTESTINE & RECTUM



Straight **Baby-Kocher** Curved
 BI 24-7144-13 BI 24-7145-13
 13 cm/5" 13 cm/5"



Kocher



BI 24-7146-22
 22 cm/8¾"



BI 24-7146-25
 25 cm/10"



BI 24-7146-28
 28 cm/11"



BI 24-7147-22
 22 cm/8¾"



BI 24-7147-25
 25 cm/10"

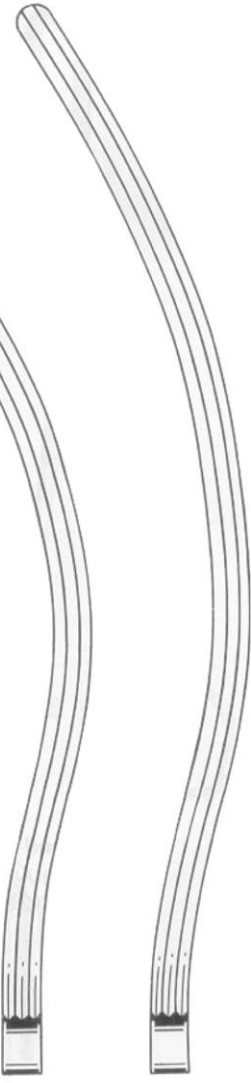

BI 24-7147-28
 28 cm/11"





Atrauma



Kocher-Atrauma

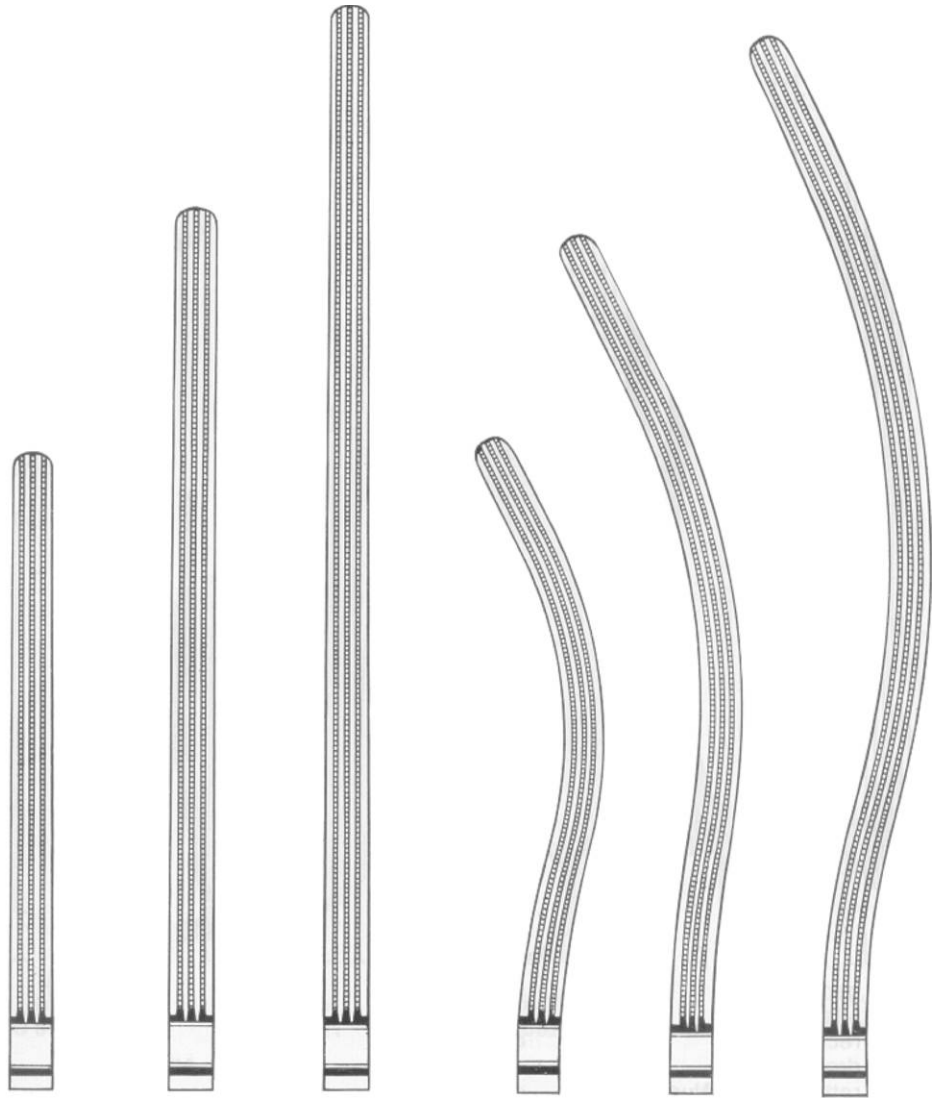

BI 24-7148-22
22 cm/8¾"

BI 24-7148-25
25 cm/10"

BI 24-7148-28
28 cm/11"

BI 24-7149-22
22 cm/8¾"

BI 24-7149-25
25 cm/10"

BI 24-7149-28
28 cm/11"

STOMACH, INTESTINE & RECTUM

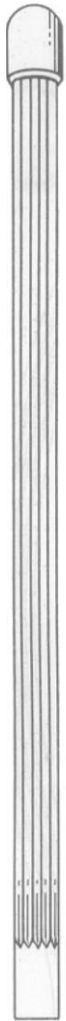

Straight
 BI 24-7151-25
 BI 24-7151-30



Nussbaum
 25 cm/10"
 30 cm/12"



Curved
 BI 24-7152-25
 BI 24-7152-30



Benson
 BI 24-7150-15
 15.5 cm/6"



Pylorus spreader



Allen
 BI 24-7153-15 15.5 cm/6"
 BI 24-7153-20 20.0 cm/8"



Kleinschmidt
 BI 24-7154-12
 12 cm/4¾"

Blindgut forceps





Payr
(Payr-Baby)

For children

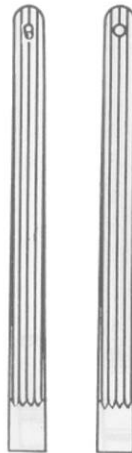

BI 24-7155-15
15 cm/6"

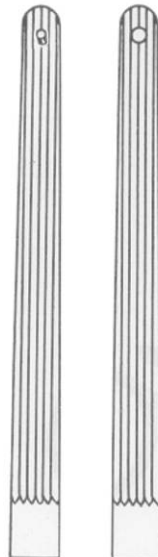

BI 24-7156-21
21 cm/8¼"

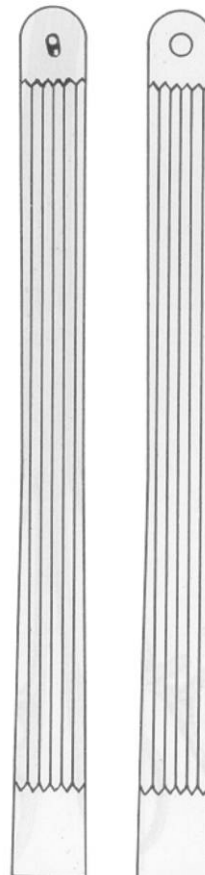

BI 24-7157-29
29 cm/11½"

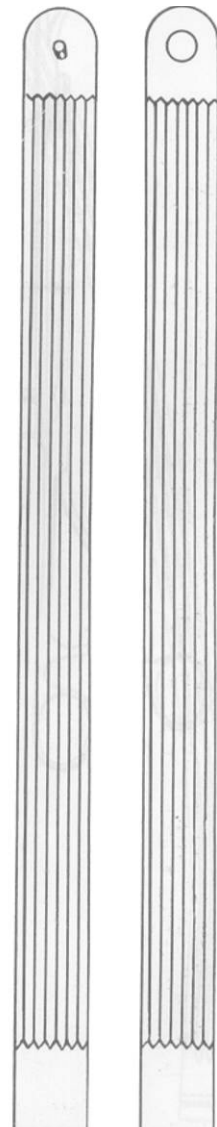

BI 24-7158-35
35 cm/13¾"

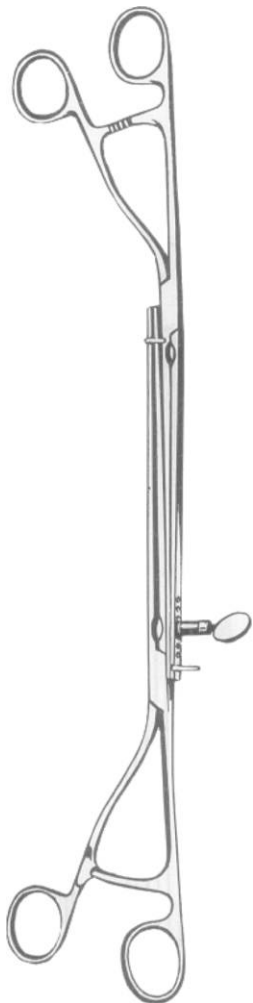

Lane
 30 cm/12"

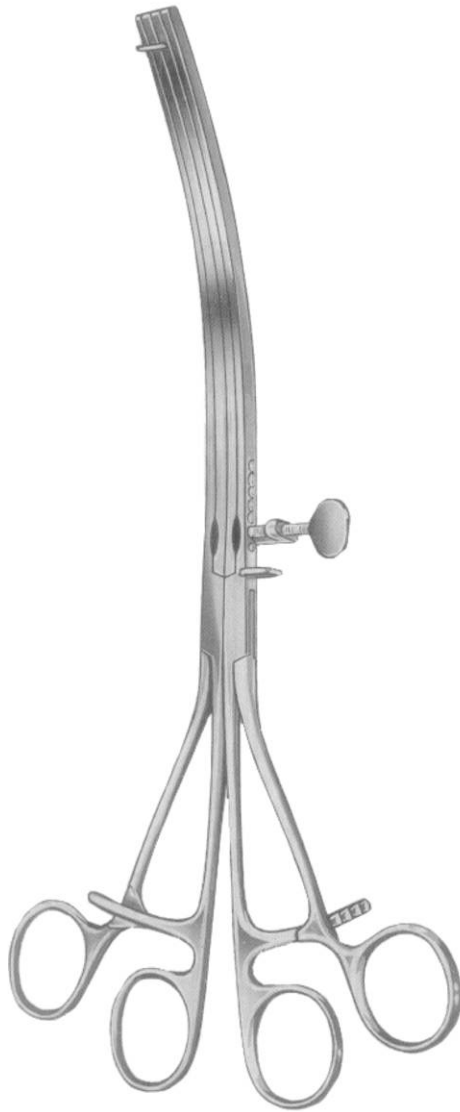

Twin Clamps Forceps



Straight
 BI 24-7159-30

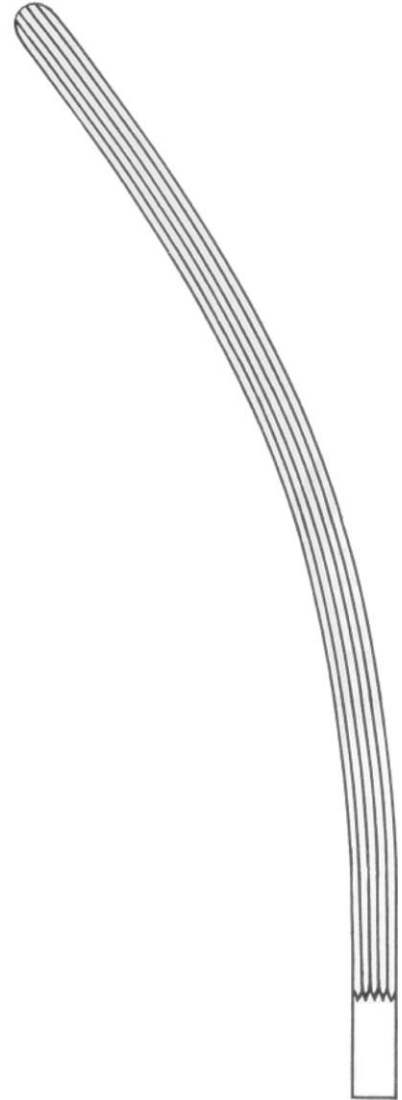

Curved
 BI 24-7160-30



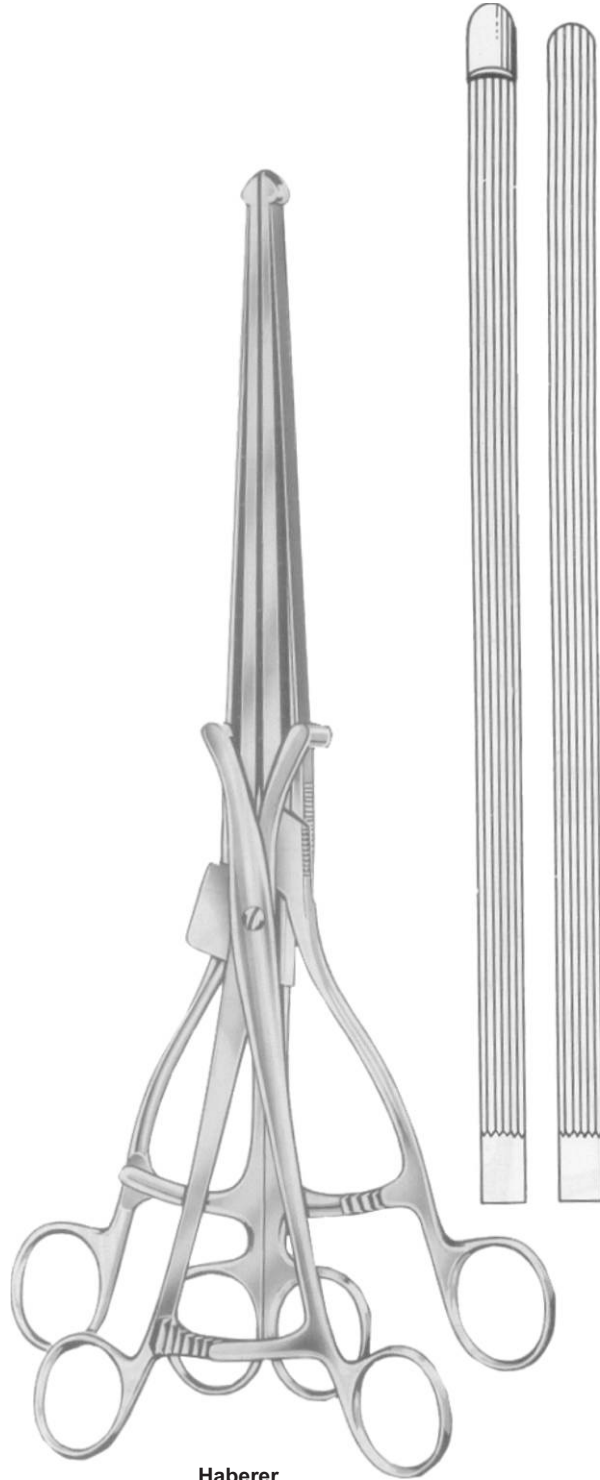

Haberer
BI 24-7161-36
36 cm/14"

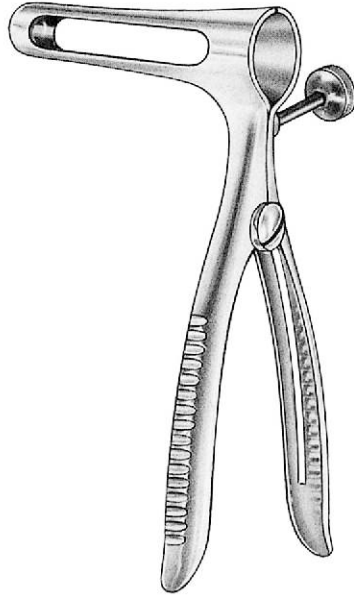

SIMS
 BI 24-7162-15
 15.0cm

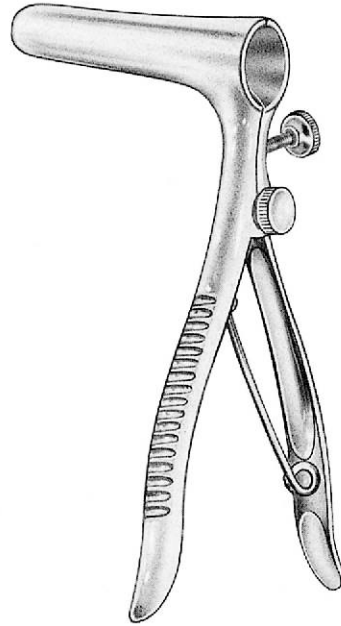

SIMS
 BI 24-7163-15
 15.0cm

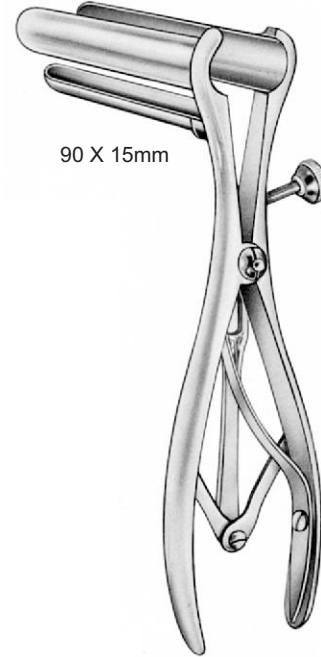

90 X 15mm

MATHIEU
 BI 24-7164-19
 19.5cm

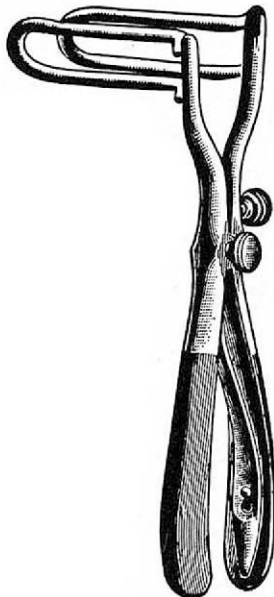

SIMS
 BI 24-7165-15
 15.0cm

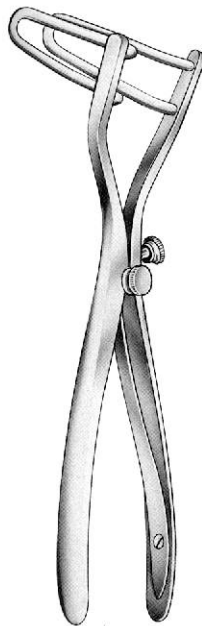

SCHULZE-BERGMANN
 22.0cm
 BI 24-7166-06 60mm
 BI 24-7166-08 80mm
 BI 24-7166-12 125mm
 BI 24-7166-15 150mm

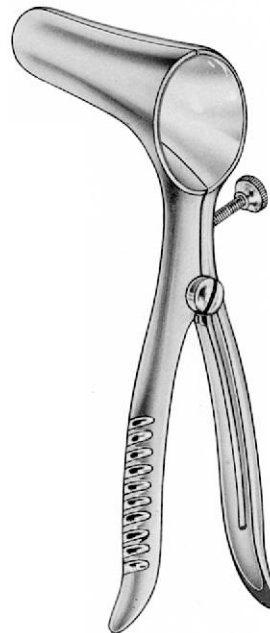

PRATT
 BI 24-7167-21
 21.5cm

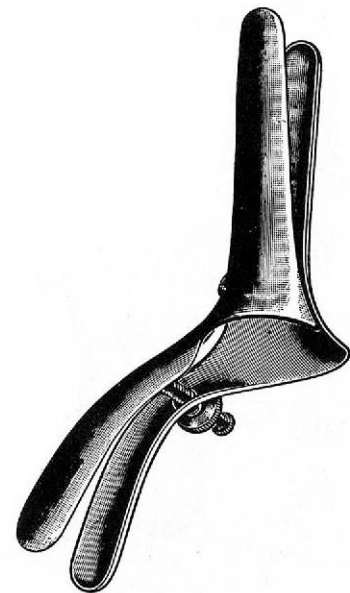

RICORD
 BI 24-7168-00





KELLY
BI 24-7169-01 21mm Ø x 50mm
BI 24-7169-02 27mm Ø x 50mm

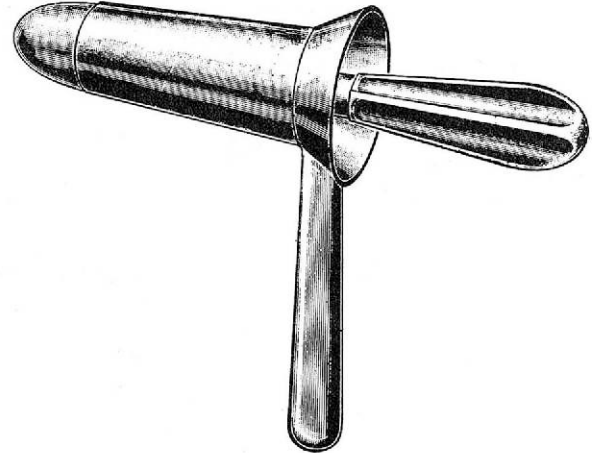

KELLY
BI 24-7170-01 25mm Ø x 64mm
BI 24-7170-02 22mm Ø x 35mm

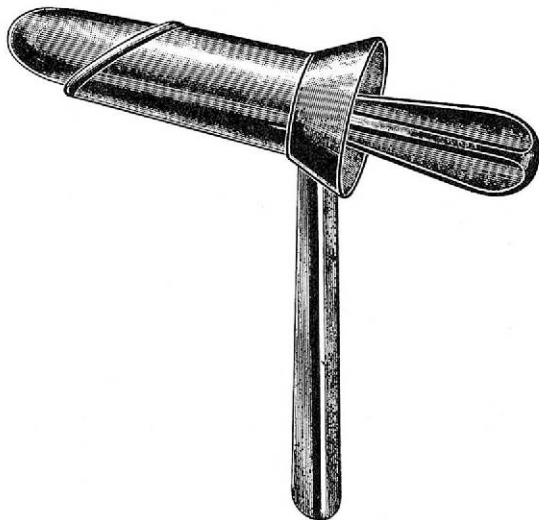

GRAEME-ANDERSON
BI 24-7171-00
24mm Ø x 64mm



GABRIEL
BI 24-7172-01 24mm Ø x 64mm
BI 24-7172-02 19mm Ø x 49mm



KELLY

- BI 24-7173-01 22mm Ø x 50mm
- BI 24-7173-02 22mm Ø x 100mm
- BI 24-7173-03 22mm Ø x 140mm
- BI 24-7173-04 22mm Ø x 200mm

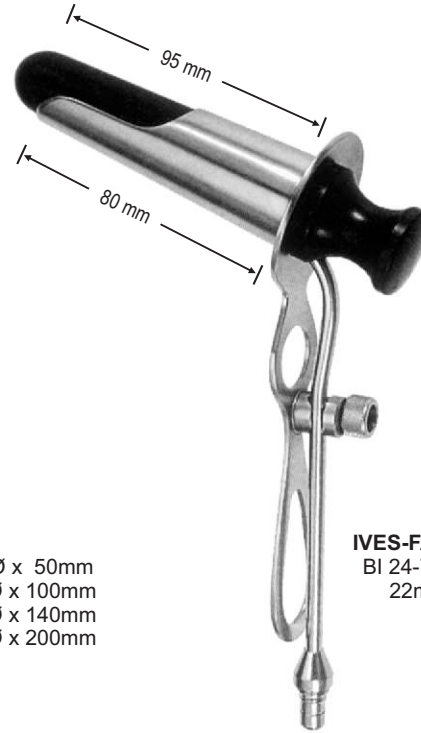

IVES-FANSLER

- BI 24-7174-15
22mm Ø



HIRSCHMANN

- BI 24-7175-01 16mm Ø x 65mm
- BI 24-7175-02 19mm Ø x 65mm
- BI 24-7175-03 22mm Ø x 65mm



KELLY

- BI 24-7176-01 22mm Ø x 50mm
- BI 24-7176-02 22mm Ø x 100mm
- BI 24-7176-03 22mm Ø x 140mm





MOD. MARTIN

BI 24-7177-01 22mm Ø X 50mm
 BI 24-7177-02 22mm Ø X 75mm
 BI 24-7177-03 22mm Ø X 100mm



NEWMAN

BI 24-7178-01 16mm Ø X 63mm
 BI 24-7178-02 19mm Ø X 63mm
 BI 24-7178-03 23mm Ø X 63mm



BENSAUDE

BI 24-7179-01 19mmØ X 70mm
 BI 24-7179-02 22mmØ X 70mm

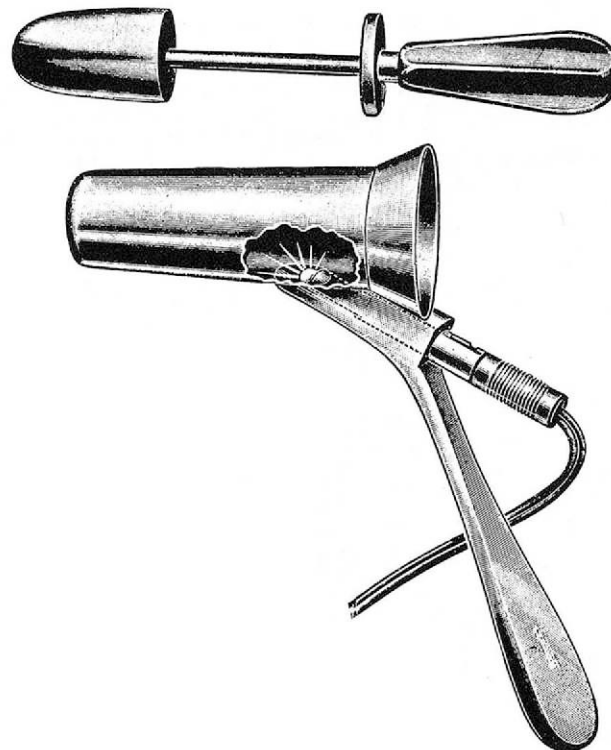

NAUNTON-MORGAN

BI 24-7180-00
 22mmØ X 70mm



BARR
 BI 24-7181-17
 17.0cm

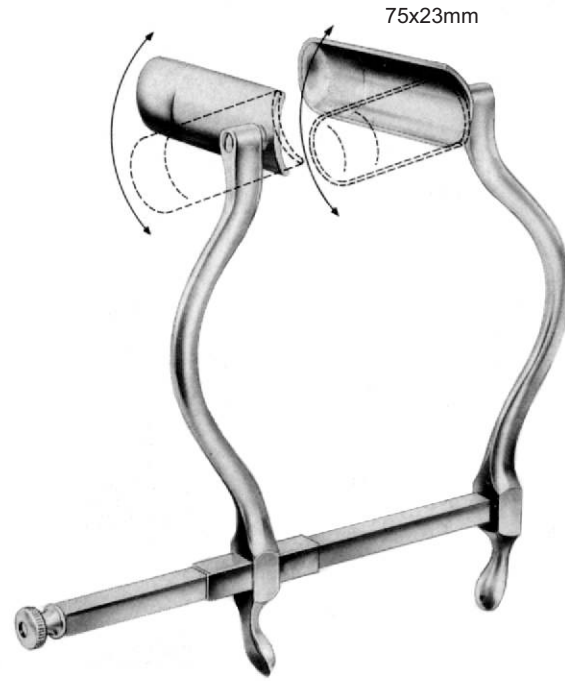

BIITH-BUIE
 BI 24-7182-15
 15.0cm



ALAN PARKS
 13.5cm
 BI 24-7183-00 complete
 BI 24-7183-04 centre blade
 BI 24-7183-13 frame only



BI 24-7183-01
 72mm



BI 24-7183-02
 90mm



BI 24-7183-03
 94mm



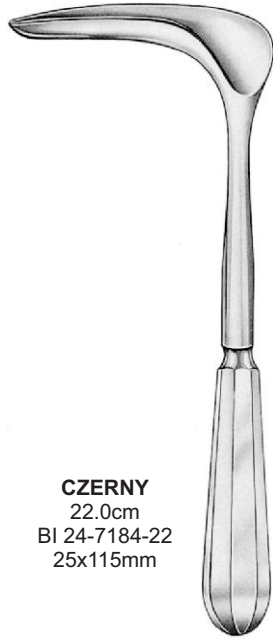

CZERNY
22.0cm
BI 24-7184-22
25x115mm



SAWYER
23.0cm
BI 24-7185-01 65x22mm
BI 24-7185-02 75x28mm
BI 24-7185-03 90x38mm

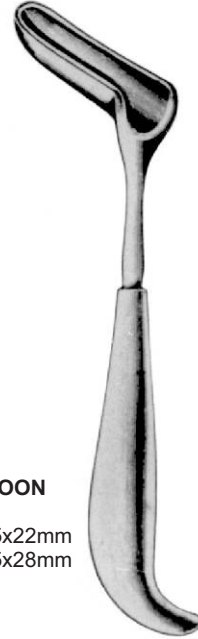

FERGUSON-MOON
21.0cm
BI 24-7186-01 65x22mm
BI 24-7186-02 75x28mm



BUIE
13.5cm
BI 24-7187-13 light
BI 24-7188-13 heavy



LARRY
BI 24-7189-18
18.0cm



ROSER
BI 24-7190-17
17.0cm



PRATT
22.0cm



BI 24-7191-01



BI 24-7191-02

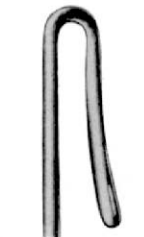

BI 24-7191-03



BARR
BI 24-7192-23
23.0cm



BARR
BI 24-7193-14
14.0cm

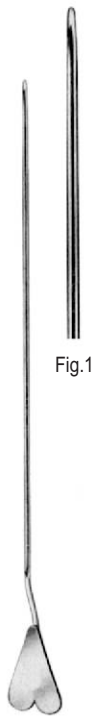

Fig.1

BI 24-7194-01
 Fig.1 straight



Fig.2

BI 24-7194-02
 Fig.2 45° curved



Fig.3

BI 24-7194-03
 Fig.3 90° curved

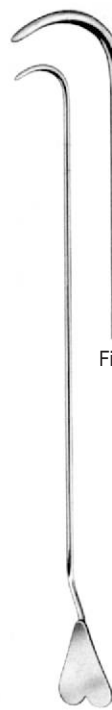
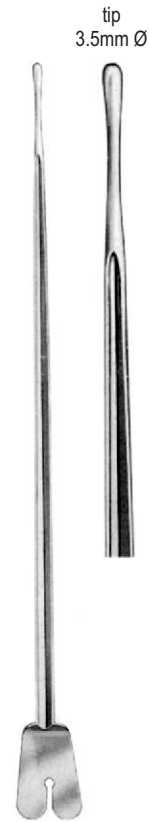

Fig.4

BI 24-7194-04
 Fig.4 retrograde curved

LOCKHART-MUMMERY
 16.5cm



tip
 3.5mm Ø

BRODIE
 20.0cm

BI 24-7195-20



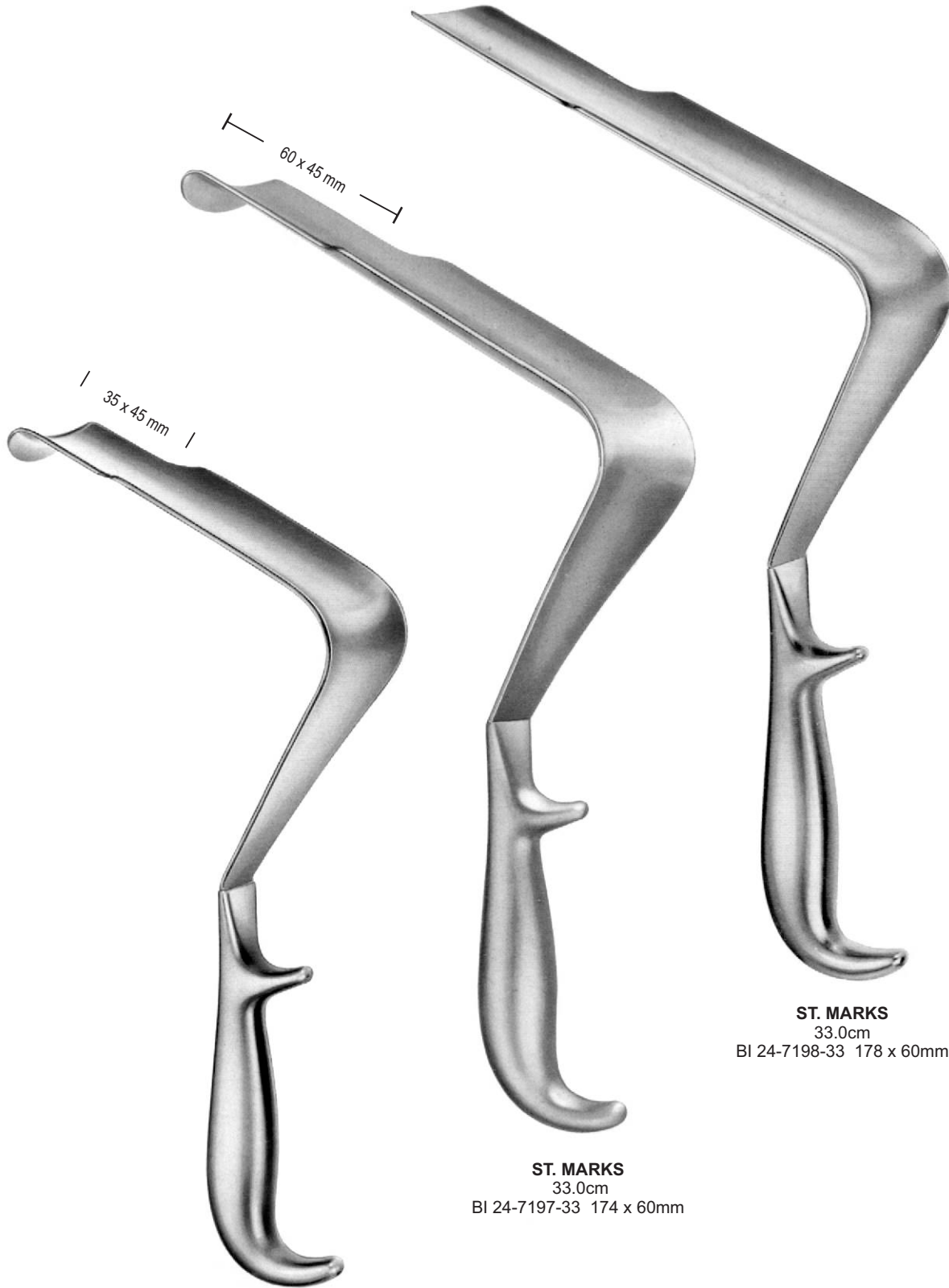

ST. MARKS
29.0cm
BI 24-7196-29 124x60mm

ST. MARKS
33.0cm
BI 24-7197-33 174 x 60mm

ST. MARKS
33.0cm
BI 24-7198-33 178 x 60mm

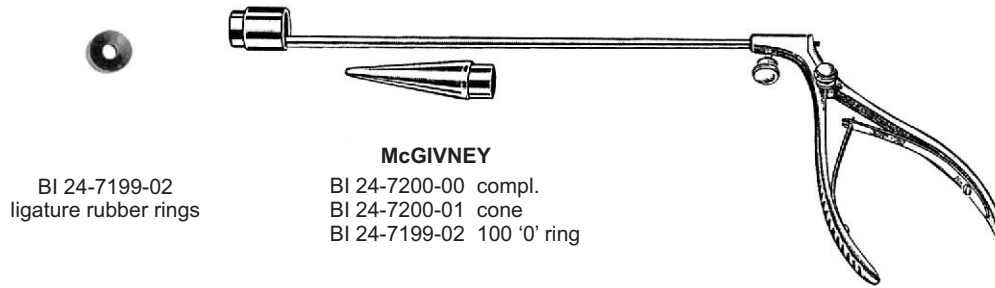

BI 24-7199-02
 ligature rubber rings

McGIVNEY
 BI 24-7200-00 compl.
 BI 24-7200-01 cone
 BI 24-7199-02 100 '0' ring

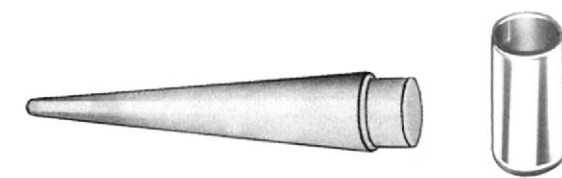

Loading Cone only BI 24-7201-01
 Suction Head BI 24-7201-11 10x11mm
 BI 24-7201-16 10x16mm

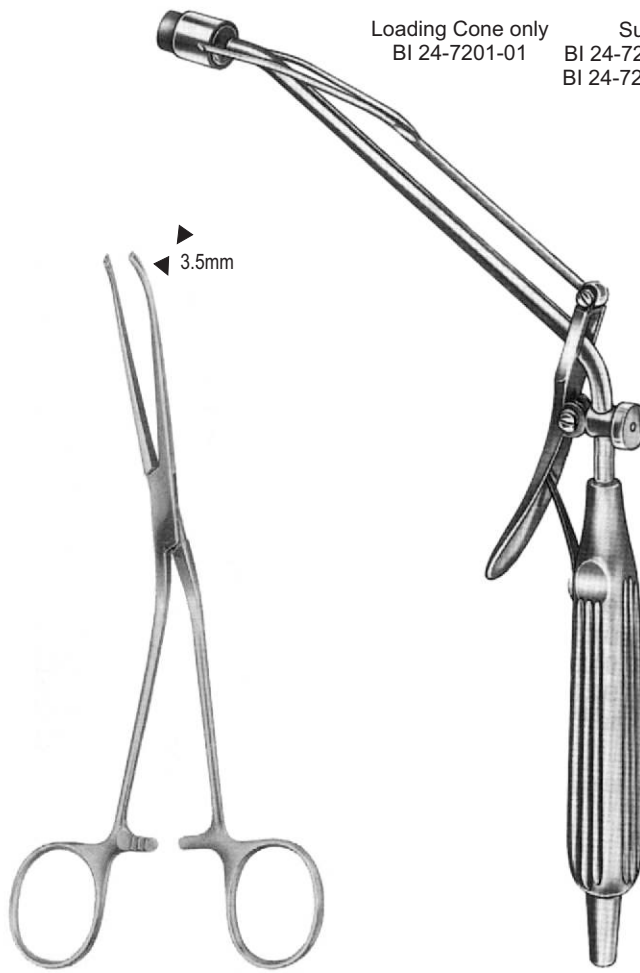

McGIVNEY
 BI 24-7202-18
 18.5cm



RUDD
 BI 24-7204-31 31.5cm
 BI 24-7201-01 cone
 BI 24-7199-02 100 '0' ring

18.5cm
 BI 24-7203-00 Set
 BI 24-7201-01 Cone
 BI 24-7201-11 Suction Head
 BI 24-7201-16 Suction Head
 BI 24-7199-02 100 '0' ring



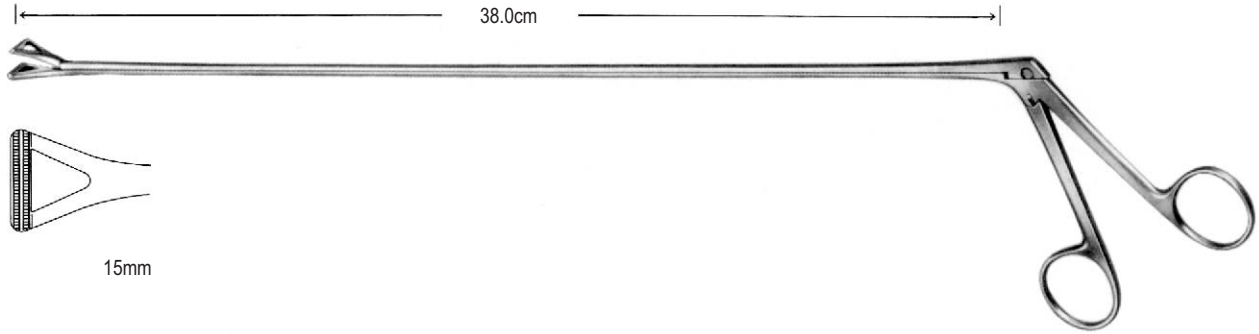

BI 24-7205-38



HEYWOOD-BIITH
BI 24-7206-21
21.0cm

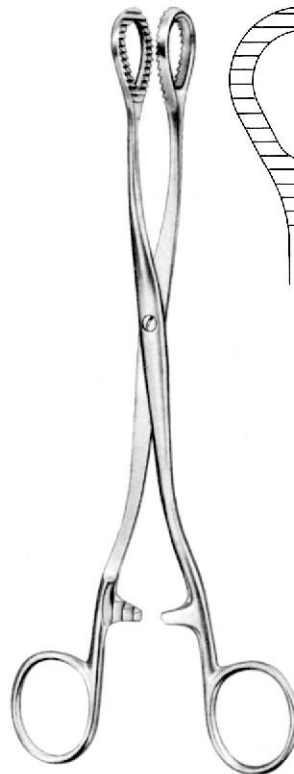
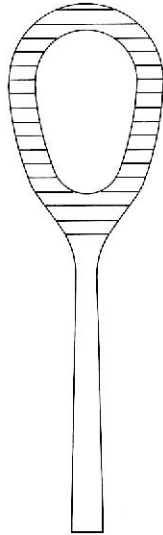

HEYWOOD-BIITH
BI 24-7207-20
20.0cm

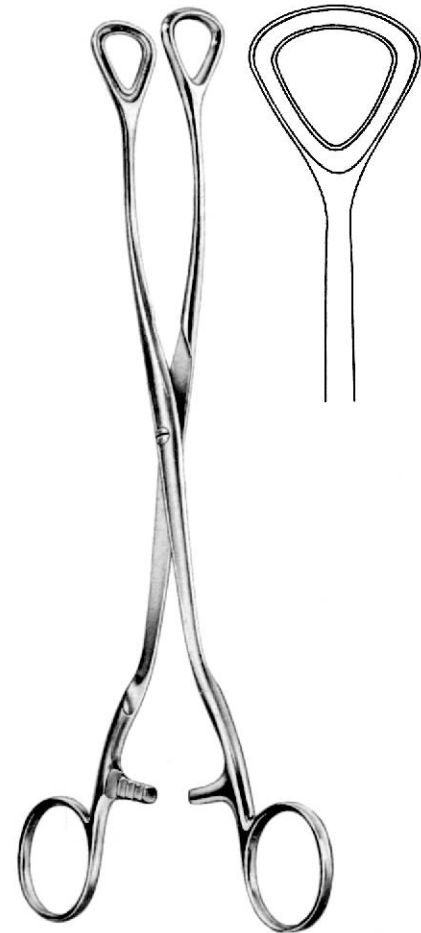
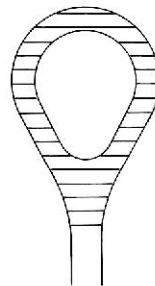

LUER
BI 24-7208-24
24.5cm

Rectal Biopsy Forceps — EN
 Mastdarm-Biopsiezange — DE
 Pinzas sacabocado — ES
 Pince à biopsie rectale — FR
 Pinza per biopsia rettale — IT

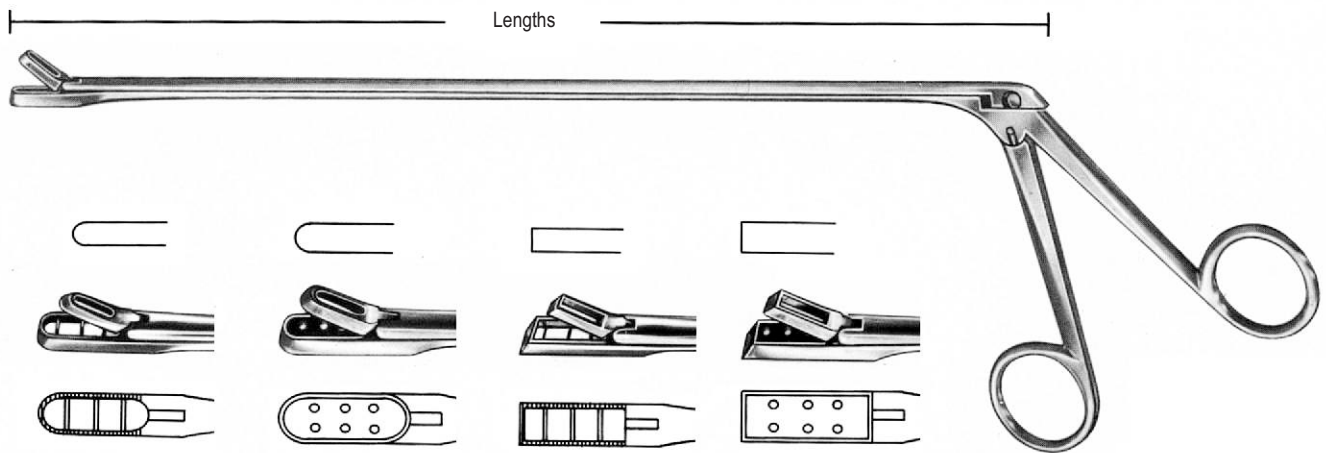
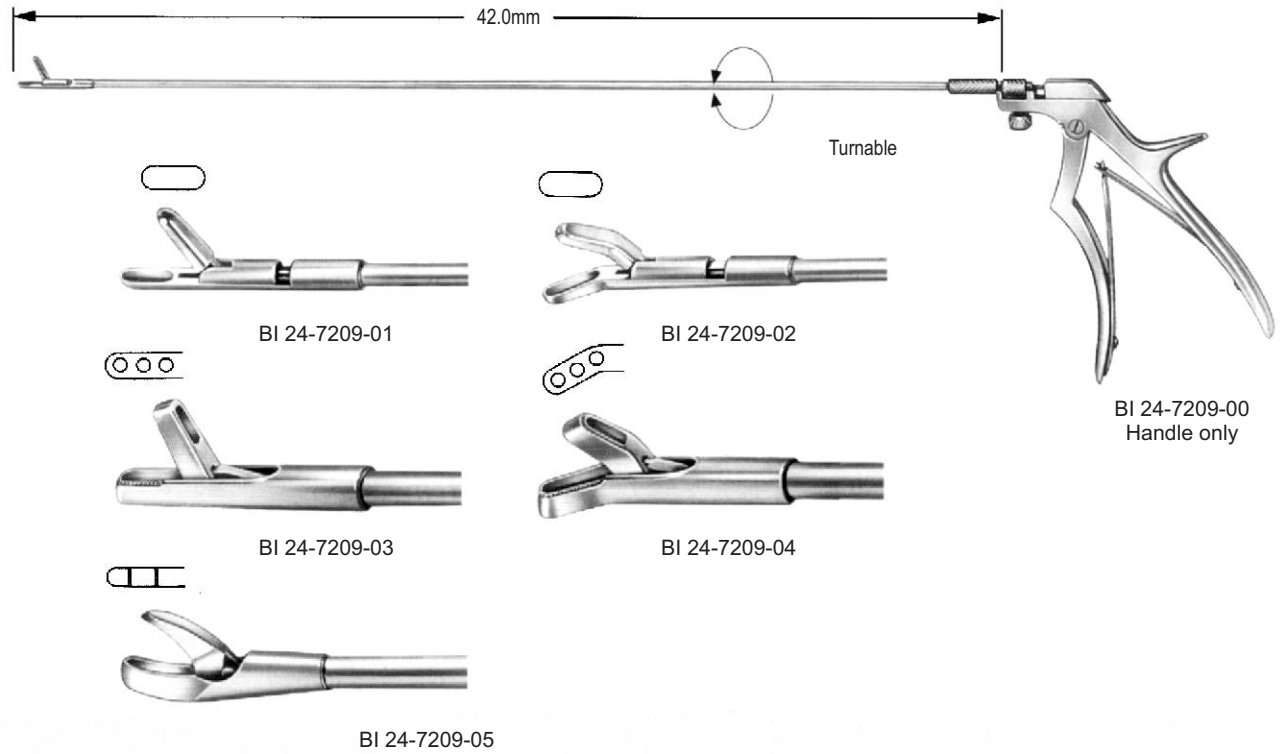

L/shaft
 28.0cm
 35.0cm
 42.0cm

BI 24-7210-28
 BI 24-7210-35
 BI 24-7210-42

BI 24-7211-28
 BI 24-7211-35
 BI 24-7211-42

BI 24-7212-28
 BI 24-7212-35
 BI 24-7212-42

BI 24-7213-28
 BI 24-7213-35
 BI 24-7213-42

YEOMAN



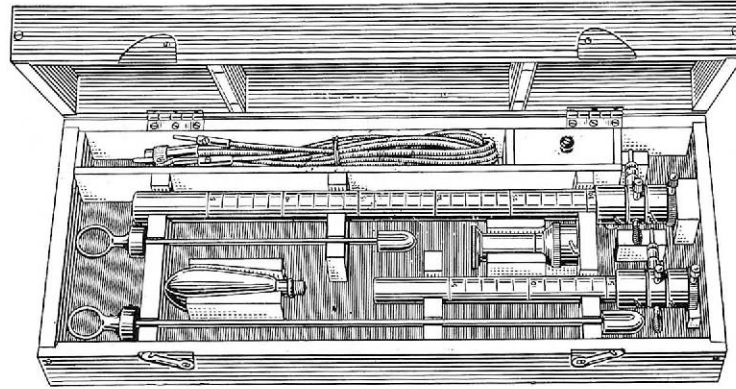

LLOYDS-DAVIES
BI 24-7214-00 complete

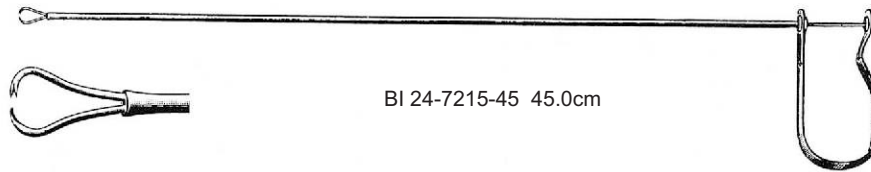

BI 24-7215-45 45.0cm

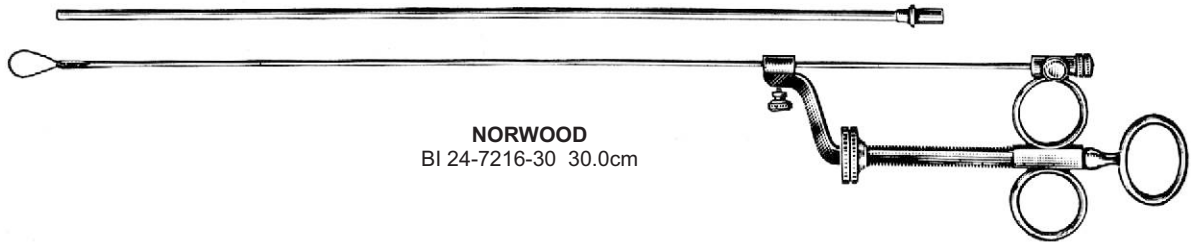

NORWOOD
BI 24-7216-30 30.0cm

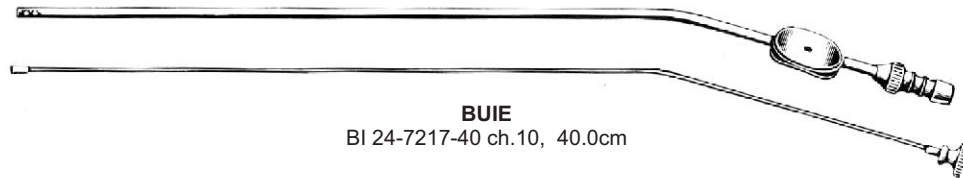

BUIE
BI 24-7217-40 ch.10, 40.0cm

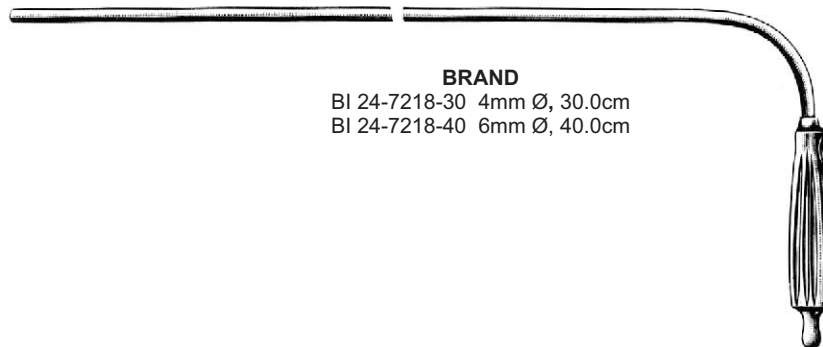

BRAND
BI 24-7218-30 4mm Ø, 30.0cm
BI 24-7218-40 6mm Ø, 40.0cm

