

**23**

- EN** Oral Instruments
- DE** Mund instrumente
- ES** Cirugía oral
- FR** Instruments oraux
- IT** Strumenti orali

**Page 575 to 595**

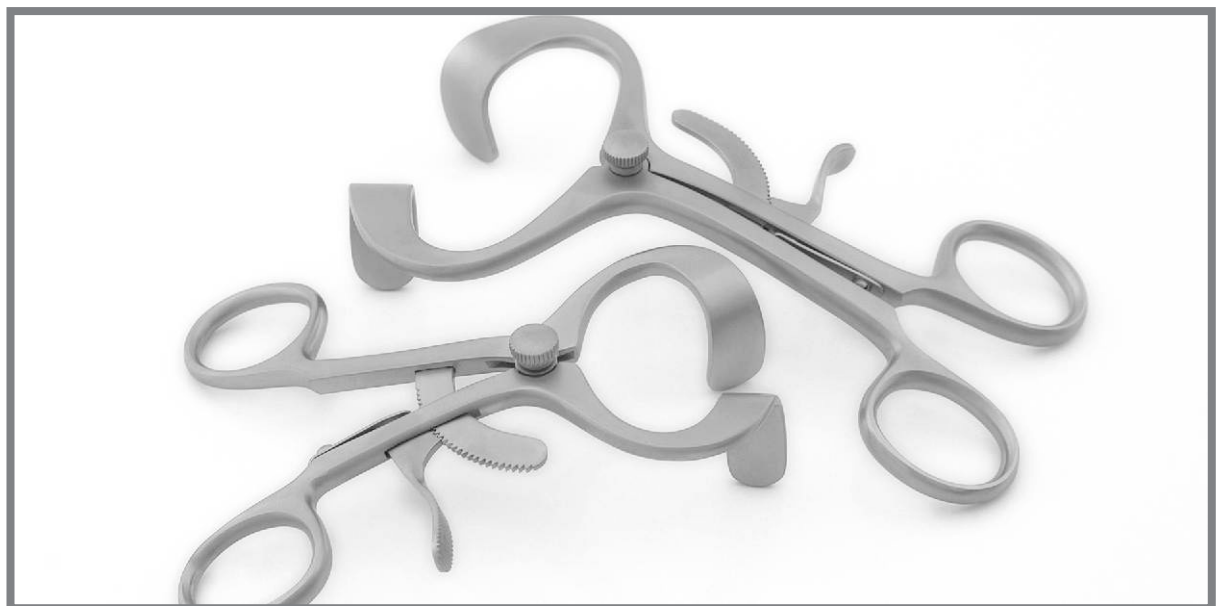

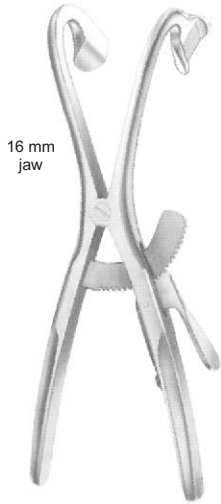

16 mm  
jaw

**DENHART**  
BI 23-6901-12  
12 cm/4 3/4"



Silicon jaws  
only (pair)  
BI 23-6903-12

**DENHART**  
BI 23-6902-12  
12 cm/4 3/4"

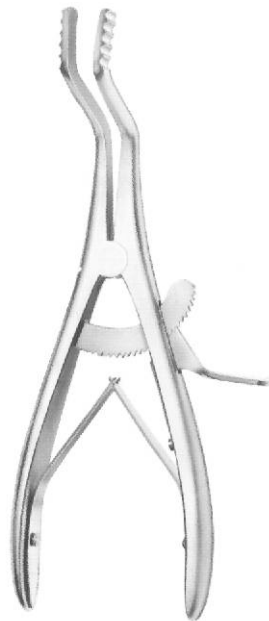

**ROSER-KONIG**

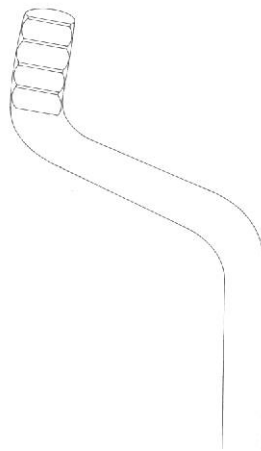

BI 23-6904-16  
16 cm/6 1/4"

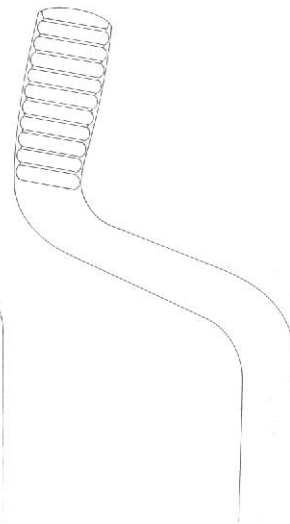

BI 23-6904-19  
19 cm/7 1/2"

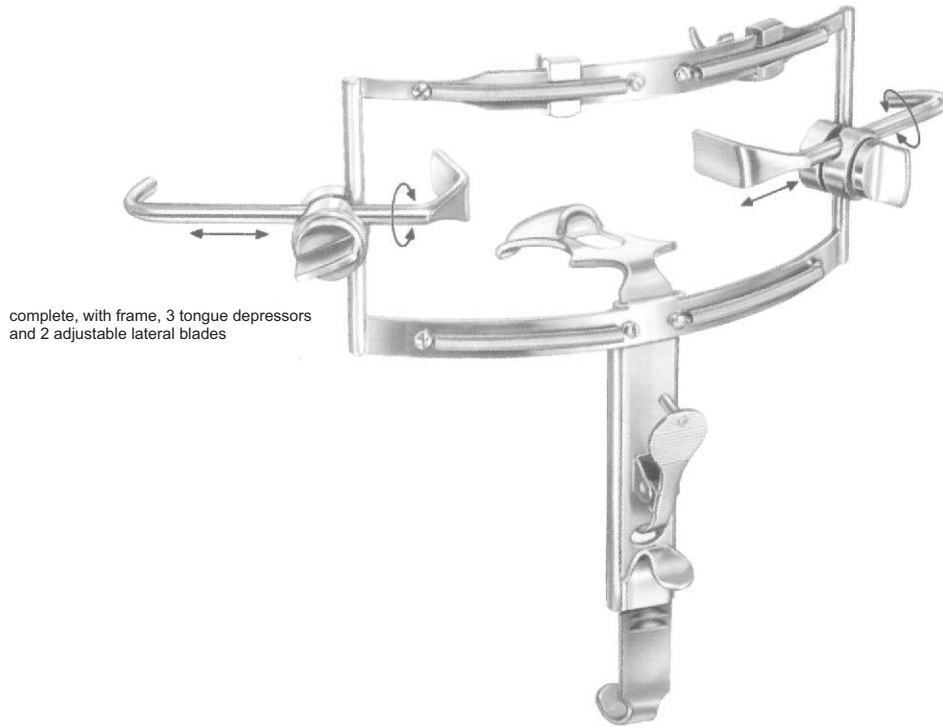

complete, with frame, 3 tongue depressors and 2 adjustable lateral blades

**DINGMAN**  
 BI 23-6905-00  
 Complete set  
 Fig. 1 - 3



BI 23-6906-01  
 62 mm x 26 mm

BI 23-6907-02  
 65 mm x 30 mm

BI 23-6908-03  
 78 mm x 32 mm

**Tongue Depressors**



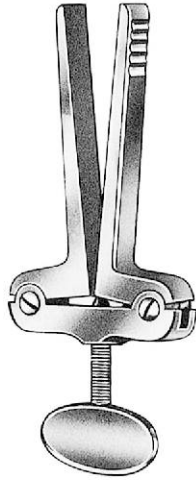

**HEISTER**  
BI 23-6909-13  
13 cm/5 1/8"



BI 23-6911-11  
Spare rubber

**MOLT**  
BI 23-6910-11  
11 cm/4 3/8"



BI 23-6913-13  
Spare Rubber

**MOLT**  
BI 23-6912-13  
13 cm/5 1/8"

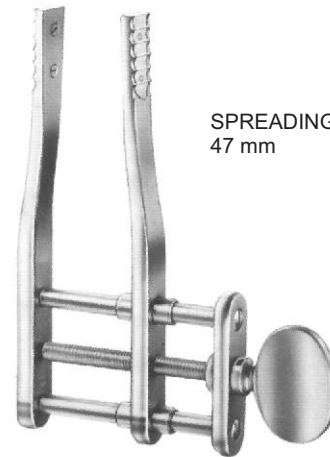

**SPREADING**  
47 mm

**OBWEGESER**  
BI 23-6914-11  
11 cm/4 3/8"

Mouth Gags ● EN  
 Mundsperrer ● DE  
 Abre-bocas ● ES  
 Bouche Gags ● FR  
 Bocca Gag ● IT

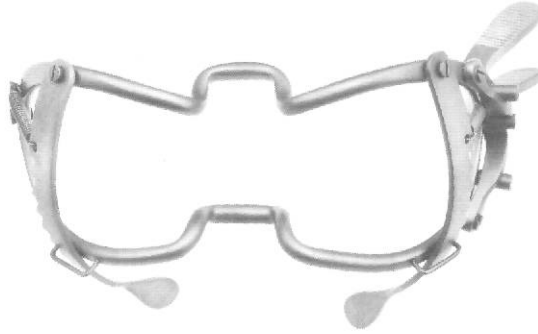

**WHITEHEAD**

BI 23-6915-11 11 cm/4  $\frac{3}{8}$ "  
 BI 23-6915-13 13 cm/5  $\frac{1}{8}$ "  
 BI 23-6915-15 15 cm/5  $\frac{1}{4}$ "

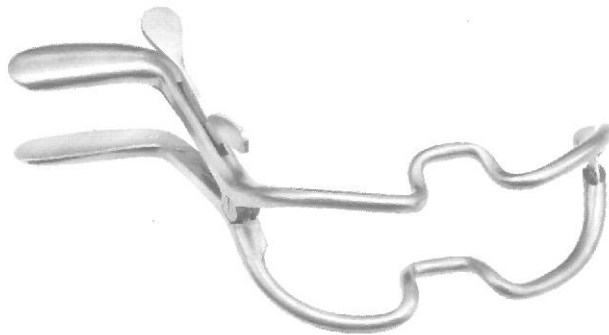

**JENNINGS**

BI 23-6916-09 9 cm/3  $\frac{1}{2}$ "  
 BI 23-6916-11 11 cm/4  $\frac{3}{8}$ "  
 BI 23-6916-13 13 cm/5  $\frac{1}{8}$ "  
 BI 23-6916-15 15 cm/5  $\frac{1}{4}$ "



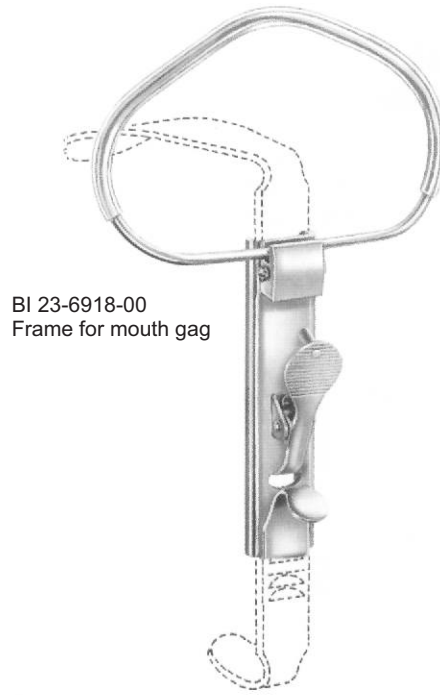

BI 23-6918-00  
Frame for mouth gag

**McLVOR**  
BI 23-6917-00  
Complete with 3  
tongue depressors

**Tongue Depressors**

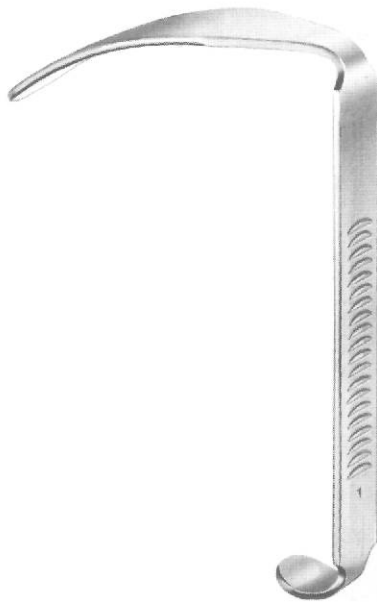

Fig. 1  
BI 23-6919-01  
100 x 25 mm

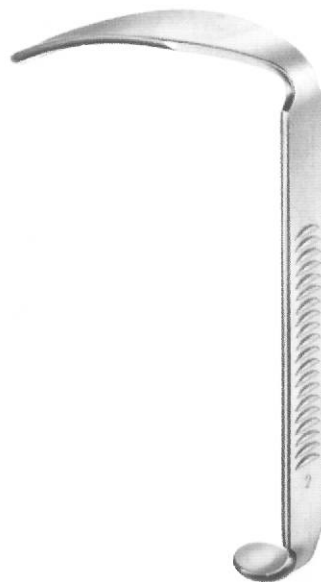

Fig. 2  
BI 23-6920-02  
85 x 25 mm

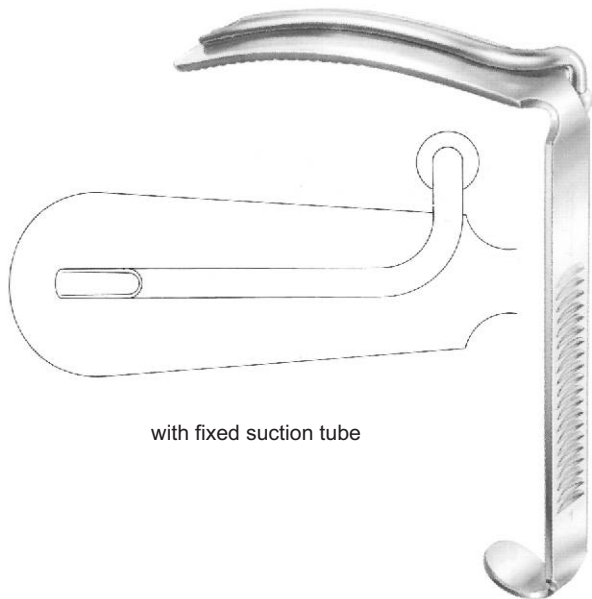

Fig. 3  
BI 23-6921-03  
75 x 25 mm

BI 23-6923-00  
 Frame for mouth gag



**DAVIS-BOYLE**  
 BI 23-6922-00  
 Complete, consisting of frame  
 and 5 tongue depressors no. 1 - 5



with fixed suction tube

Fig. 1  
 BI 23-6924-01  
 110 x 28 mm



Fig. 2  
 BI 23-6925-02  
 95 x 27 mm



Fig. 3  
 BI 23-6926-03  
 80 x 27 mm

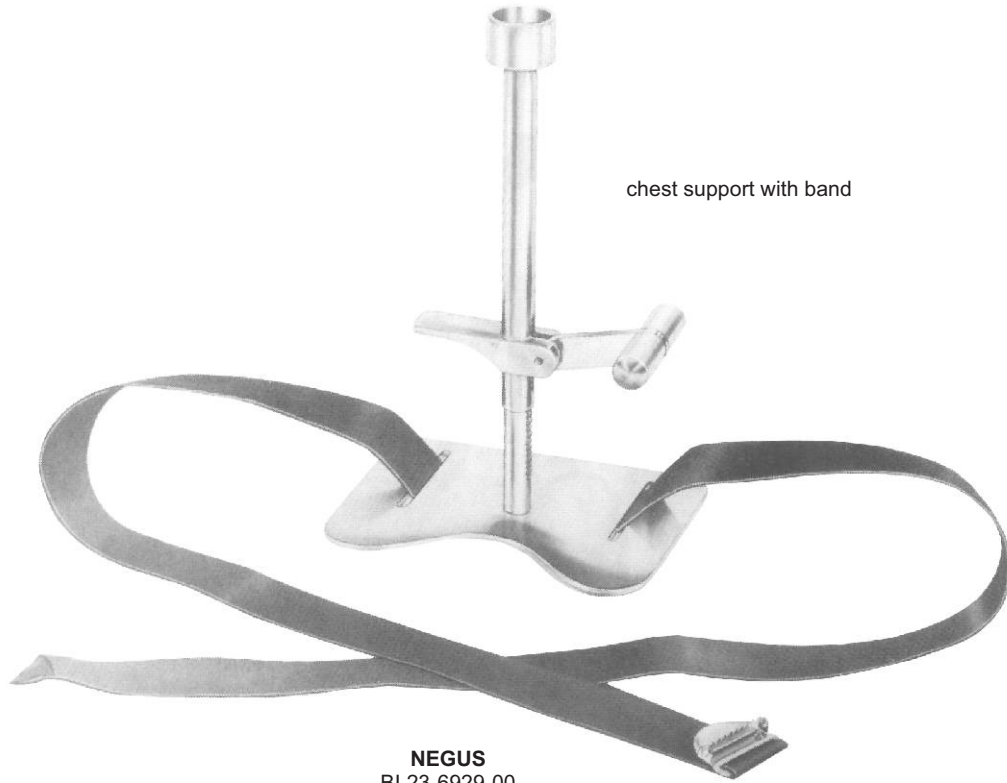

Fig. 4  
 BI 23-6927-04  
 65 x 26 mm

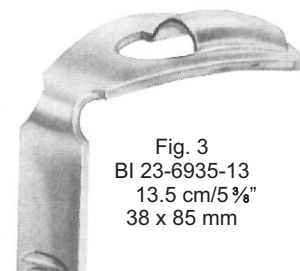
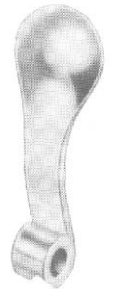

Fig. 5  
 BI 23-6928-05  
 30 x 20 mm





**KILNER-DOUGHTY**  
BI 23-6930-00



complete, consisting of frame and 3 tongue depressors  
no. 1 to 3, 2 tooth plates and 1 palate plate



**NEUKAM**  
 BI 23-6937-00  
 frame for mouth gag only



**NEUKAM**  
 BI 23-6936-00  
 complete with frame and  
 3 tongue depressors

Tongue Depressor  
 fenestrated blade for suction

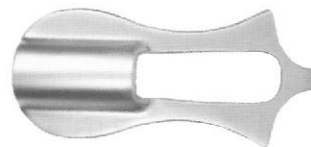
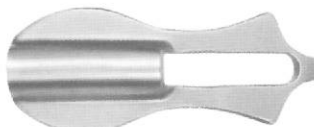
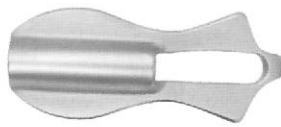

Fig. 1  
 BI 23-6938-01

Fig. 2  
 BI 23-6939-02

Fig. 3  
 BI 23-6940-03





**COLLIN**  
 BI 23-6941-16 16 cm/6 ¼"  
 BI 23-6941-18 18 cm/7 ⅛"

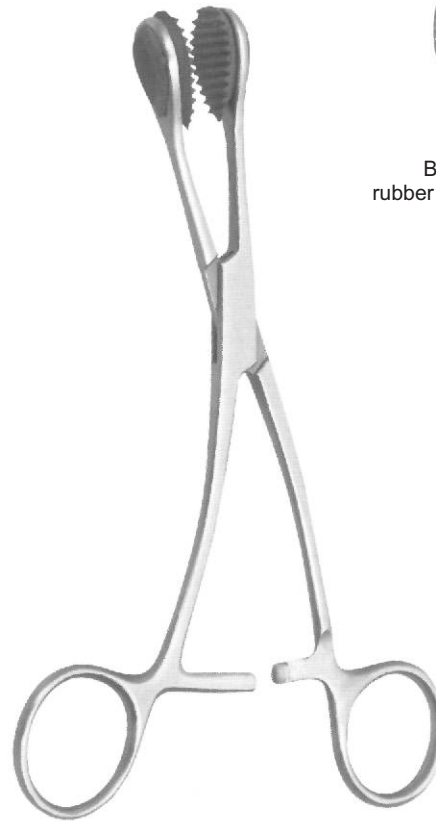

BI 23-6943-16  
 rubber inserts, only (pair)

**YOUNG**  
 BI 23-6942-16  
 16 cm/6 ¼"



BI 23-6944-15  
 15 cm/5 7/8"  
 wood  
 19 mm



BI 23-6945-15  
 15 cm/5 7/8"  
 plastic



**BRUNINGS**  
 BI 23-6946-19  
 19 cm/7 1/2"

16 mm

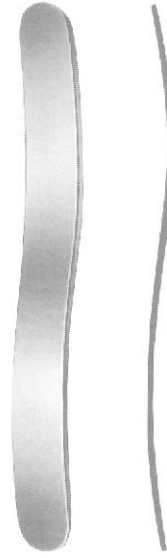

BI 23-6947-14  
 14.5 cm/5 3/4"

19 mm



23 mm

BI 23-6948-14  
 14 cm/5 1/2"



**DOYEN**

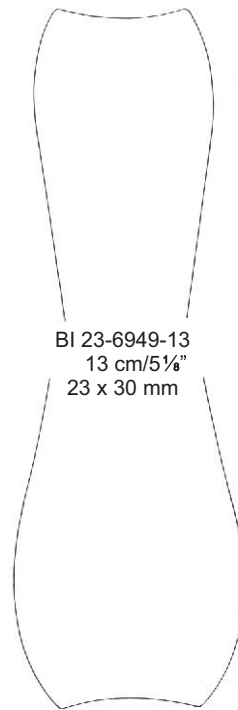

BI 23-6949-13  
 13 cm/5 1/8"  
 23 x 30 mm

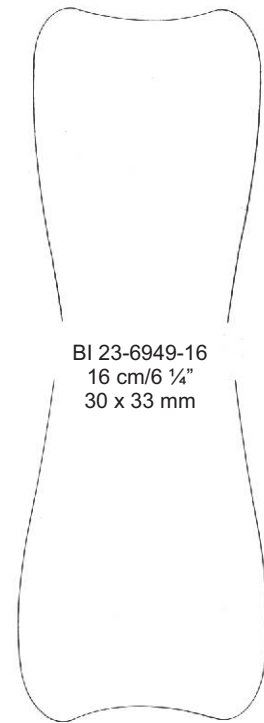

BI 23-6949-16  
 16 cm/6 1/4"  
 30 x 33 mm



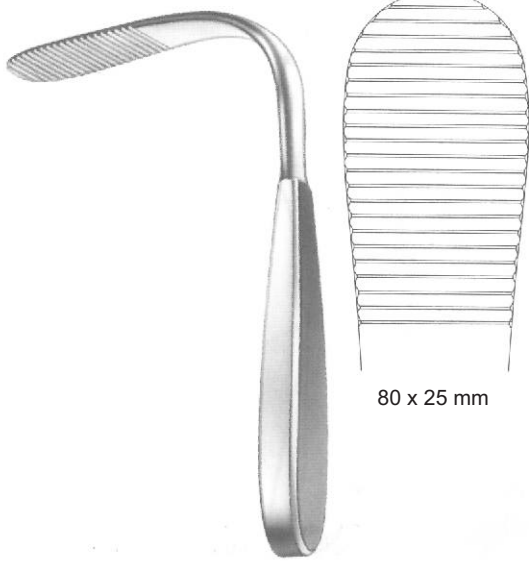

**TOBOLD**  
BI 23-6950-15  
15 cm/5 7/8"

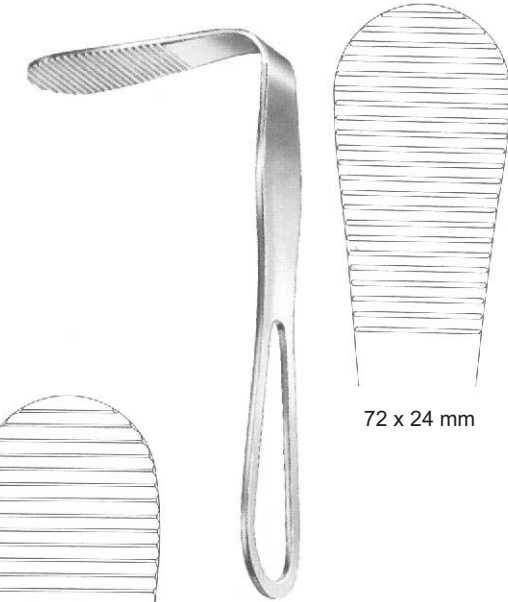

**HARTMANN**  
BI 23-6951-15  
15 cm/5 7/8"



**TOBOLD**  
BI 23-6952-16  
16 cm/6 1/4"

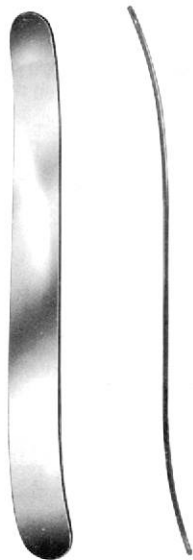

**BUCHWALD**  
BI 23-6953-18  
18 cm/7 1/8"



**ANDREW**  
BI 23-6954-11  
11 cm/4 3/8"

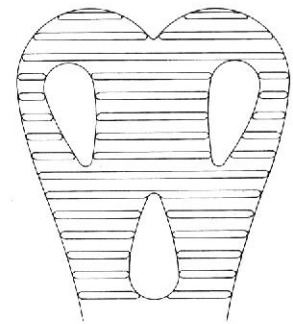

BI 23-6955-14  
14 cm/5 1/2"  
36 mm

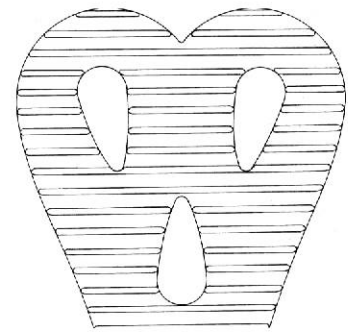

BI 23-6955-15  
15 cm/5 7/8"  
43 mm

**WIEDER**



**MARTIN-SIMPLEX**  
 BI 23-6956-10  
 10.5 cm/4 1/8"

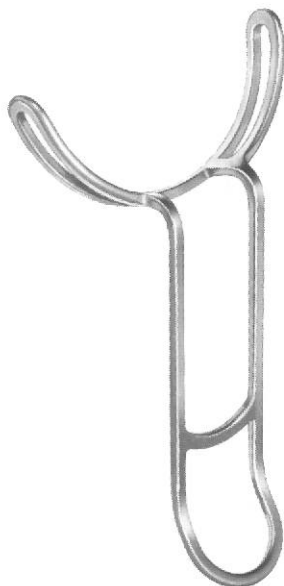

BI 23-6957-14  
 14 cm/5 1/2"  
 Vestibulum retractor



**STERNBERG**  
 BI 23-6958-14  
 14 cm/5 1/2"

26 mm

37 mm

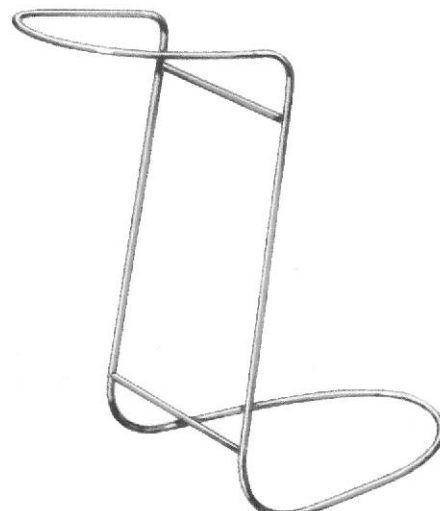

**OBWEGESER**  
 BI 23-6959-12  
 12 cm/4 3/4"



**BISHOP**  
 BI 23-6960-13  
 13.5 cm/5 3/8"



**CAWOOD-MINNESOTA**  
 BI 23-6961-15  
 15.5 cm/6 1/8"



**CAWOOD-MINNESOTA**  
 BI 23-6962-14  
 14.5 cm/5 3/4"



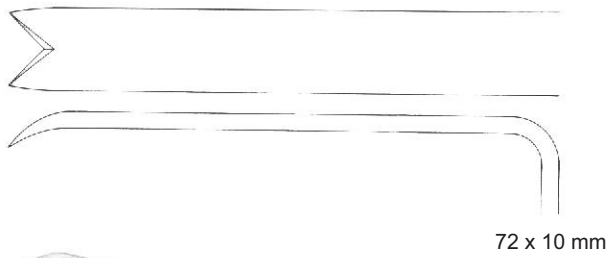

**OBWEGESER**  
BI 23-6963-22  
22 cm/8 ¾"

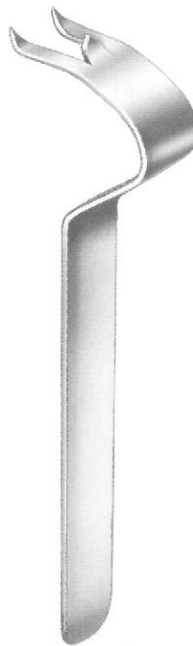

**OBWEGESER**  
BI 23-6964-16  
16.5 cm/6 ½"



BI 23-6965-16  
16 cm/6 ¼"  
8 mm

BI 23-6966-16  
16 cm/6 ¼"  
10 mm

**OBWEGESER**

ORAL INSTRUMENTS

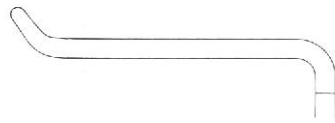

BI 23-6967-22  
 22.5 cm/8 3/4"  
 43 x 11 mm



BI 23-6967-23  
 23 cm/9"  
 57 x 11 mm

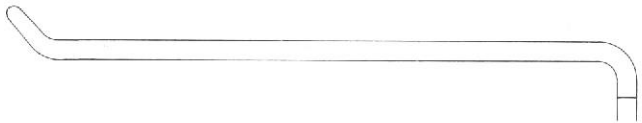

BI 23-6968-23  
 23 cm/9"  
 80 x 16 mm

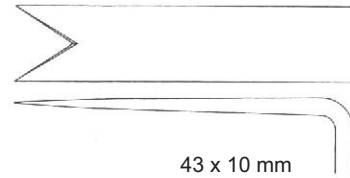

43 x 10 mm



OBWEGESER



OBWEGESER  
 BI 23-6969-22  
 22 cm/8 3/4"  
 Nasal Spine Retractor





**OBWEGESER**  
17.5 cm/6 7/8"



BI 23-6970-17



BI 23-6971-17



**KRENKEL**  
24.5 cm/9 5/8"



BI 23-6972-24  
Periosteal Elevator



BI 23-6973-24  
Periosteal Elevator

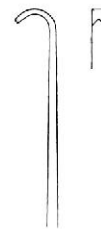

BI 23-6974-24  
Condylar repositioning  
instrument  
Fig. 11



BI 23-6975-24  
Fig. 12

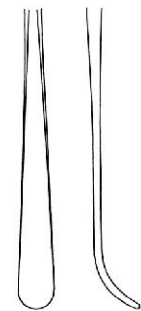





**OBWEGESER**  
17.5 cm/6 7/8"



BI 23-6976-17  
6 mm



BI 23-6977-17  
7 mm



BI 23-6978-17  
9 mm



BI 23-6979-17



**OBWEGESER**  
20 cm/7 7/8"



BI 23-6980-20  
5 mm



BI 23-6981-20  
7 mm

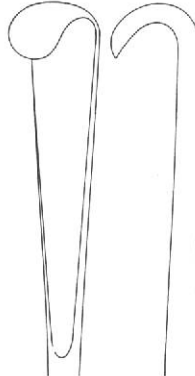

BI 23-6982-20  
9 mm





**OBWEGESER**  
 BI 23-6983-20  
 20.5 cm/8 1/8"



**OBWEGESER**  
 BI 23-6984-20  
 20.5 cm/8 1/8"



**OBWEGESER**  
 15 cm/5 7/8"



BI 23-6985-15  
 2.5 mm

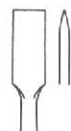

BI 23-6986-15  
 4.0 mm

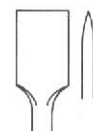

BI 23-6987-15  
 6.5 mm

ORAL INSTRUMENTS

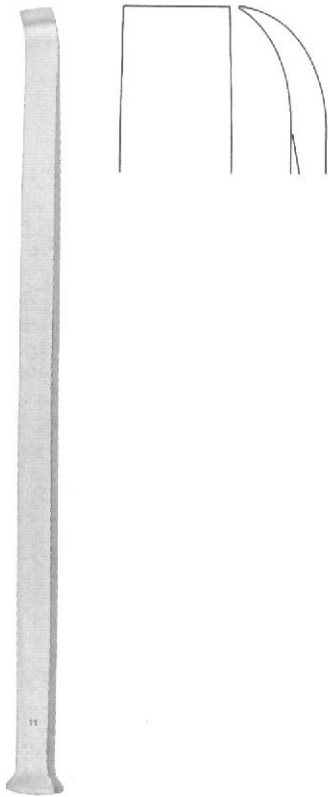

**OBWEGESER**  
 BI 23-6988-23  
 23.5 cm/9 1/4"



BI 23-6989-18

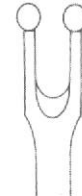

BI 23-6990-18

**OBWEGESER**  
 18.5 cm/7 1/4"



**OBWEGESER**  
 BI 23-6991-18  
 18 cm/7 1/8"



**OBWEGESER**  
 BI 23-6992-14  
 14 cm/5 1/2"



**OBWEGESER**  
 BI 23-6993-23  
 23 cm/9"



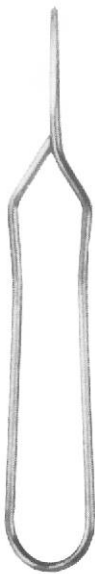

Awl for lower jaw



**KELSEY-FRY**  
BI 23-6994-15  
15 cm/5 7/8"



Awl for upper jaw



**KELSEY-FRY**  
BI 23-6995-18  
18 cm/7 1/8"

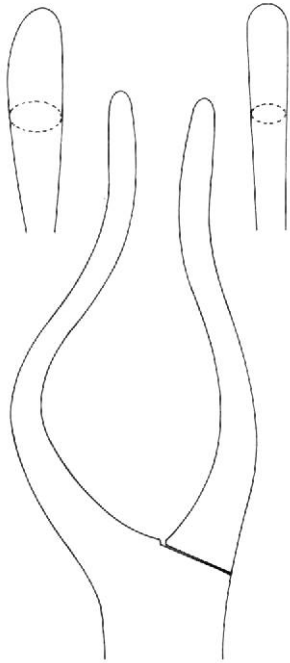

Fig. 1  
for babies

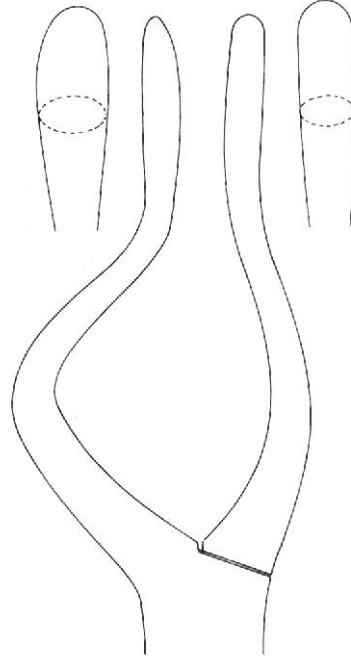

Fig. 2  
for children

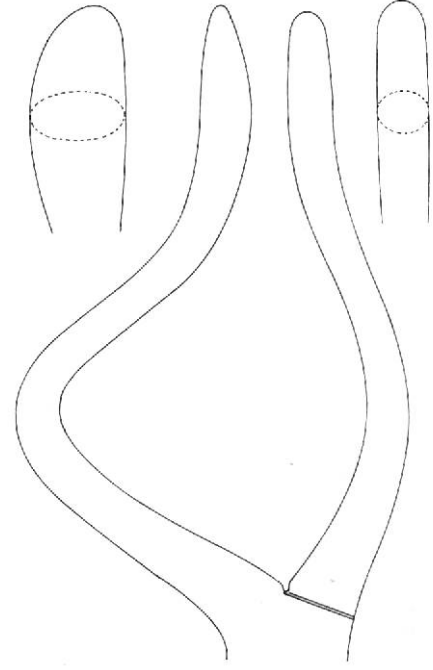

Fig. 3  
for adults



Left



Right

**ROWE**

- BI 23-6996-22 Fig. 1 22.5 cm
- BI 23-6996-23 Fig. 2 23.5 cm
- BI 23-6996-24 Fig. 3 24.0 cm

**ROWE**

- BI 23-6997-22 Fig. 1 22.5 cm
- BI 23-6997-23 Fig. 2 23.5 cm
- BI 23-6997-24 Fig. 3 24.0 cm

