

22

- EN** Rhinology
- DE** Rhinologie
- ES** Rinología
- FR** Rhinologie
- IT** Rinologia

Page 541 to 574

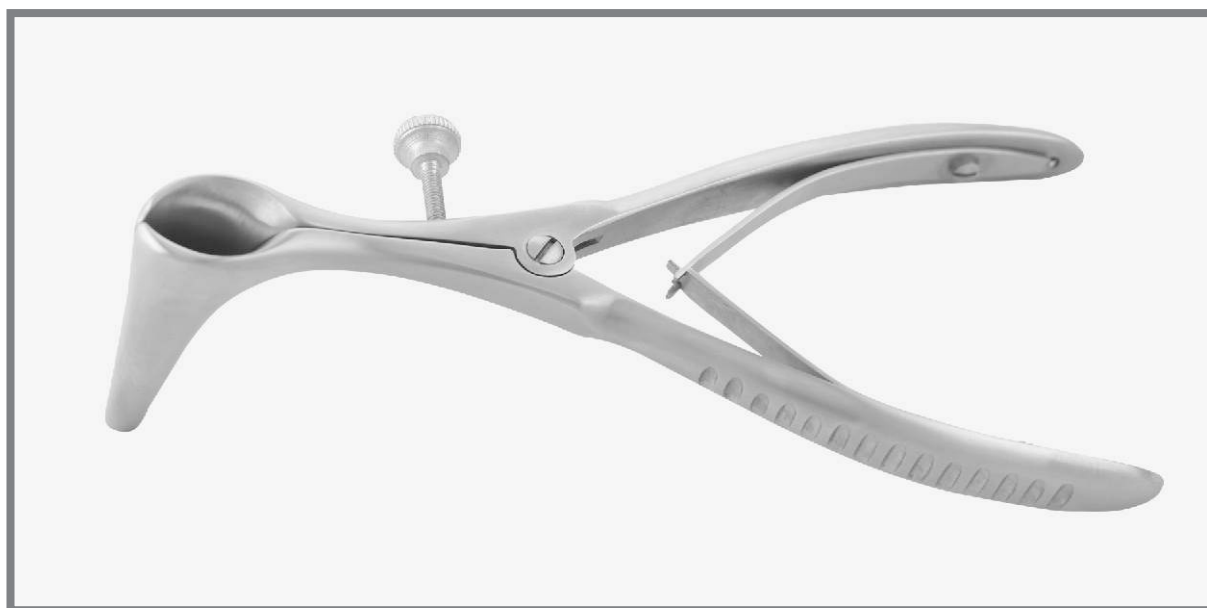

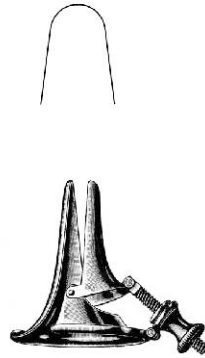

VACHER
BI 22-6601-00



VOLTOLINI



BI 22-6602-01



BI 22-6602-02



BI 22-6602-03

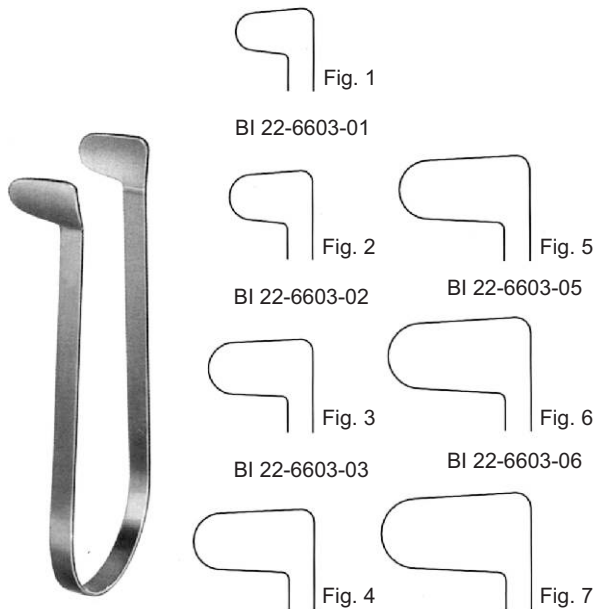

GOLDBIITH (Thudichum)
BI 22-6603-00 set / 7

Fig. 1
BI 22-6603-01

Fig. 2
BI 22-6603-02

Fig. 3
BI 22-6603-03

Fig. 4
BI 22-6603-04

Fig. 5
BI 22-6603-05

Fig. 6
BI 22-6603-06

Fig. 7
BI 22-6603-07

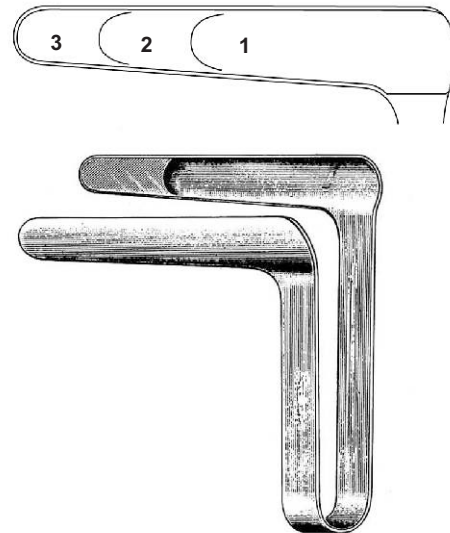

ST. CLAIR THOMSON

BI 22-6604-00 set / 3
BI 22-6604-01 35mm Fig. 1
BI 22-6604-02 50mm Fig. 2
BI 22-6604-03 75mm Fig. 3

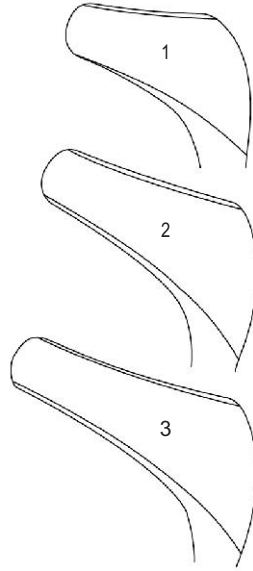

HARTMANN-HALLE
 15.0cm
 BI 22-6605-01 Fig. 1
 BI 22-6605-02 Fig. 2
 BI 22-6605-03 Fig. 3

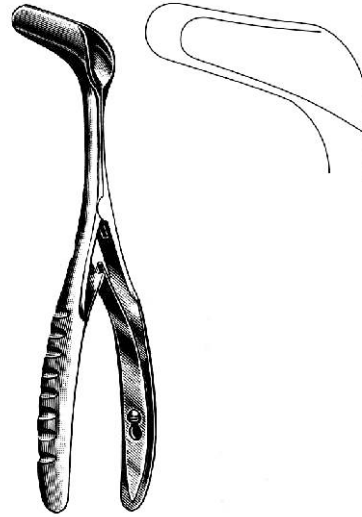

SCHWARZ
 BI 22-6606-14
 14.0cm



VIENNA
 14.5cm
 BI 22-6607-01 (infant)
 BI 22-6607-02 (child)
 BI 22-6607-03 (adult)
 BI 22-6607-04 (sheet metal)

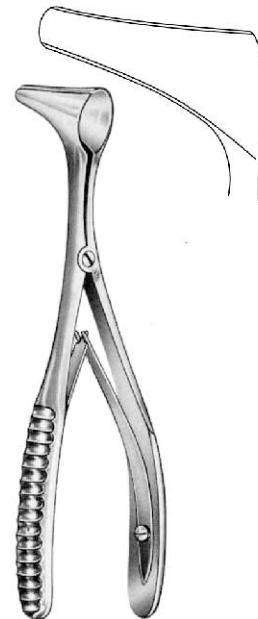

MOD WIEN
 BI 22-6608-14
 14.5cm





Pediatrics

BI 22-6609-13
13.0cm



BI 22-6610-13
13.0cm

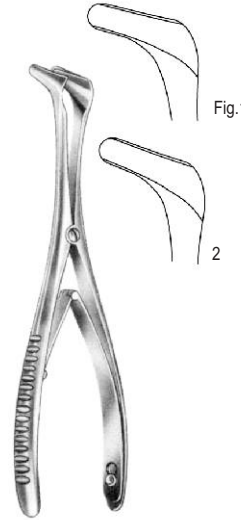

Fig.1

TIECK-HALLE
13.5cm
BI 22-6611-01
BI 22-6611-02



2

TIECK-HALLE
BI 22-6612-13
13.5cm



KILLIAN
13.0cm
BI 22-6613-35
BI 22-6613-50
BI 22-6613-75
BI 22-6613-90

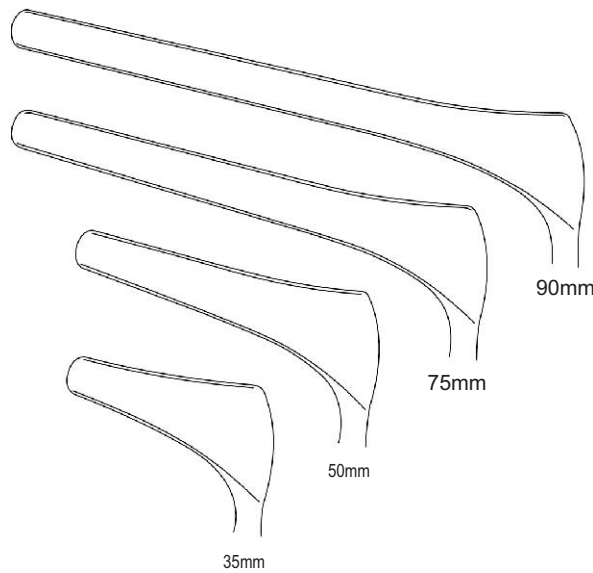

KILLIAN (with side screw)
13.0cm
BI 22-6614-35
BI 22-6614-50
BI 22-6614-75
BI 22-6614-90



COTTLE
 15.0cm
 BI 22-6615-35
 BI 22-6615-50
 BI 22-6615-75
 BI 22-6615-90

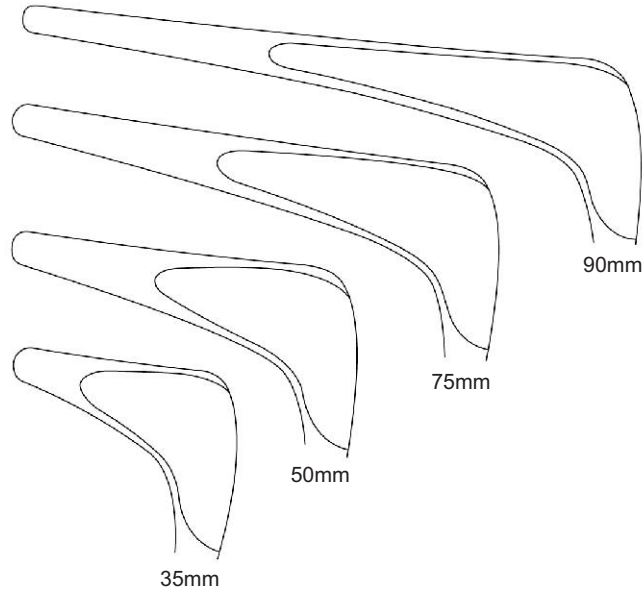

COTTLE (with side screw)
 15.0cm
 BI 22-6616-35
 BI 22-6616-50
 BI 22-6616-75
 BI 22-6616-90



COTTLE
 (dull black chromium plated)
 14.0cm

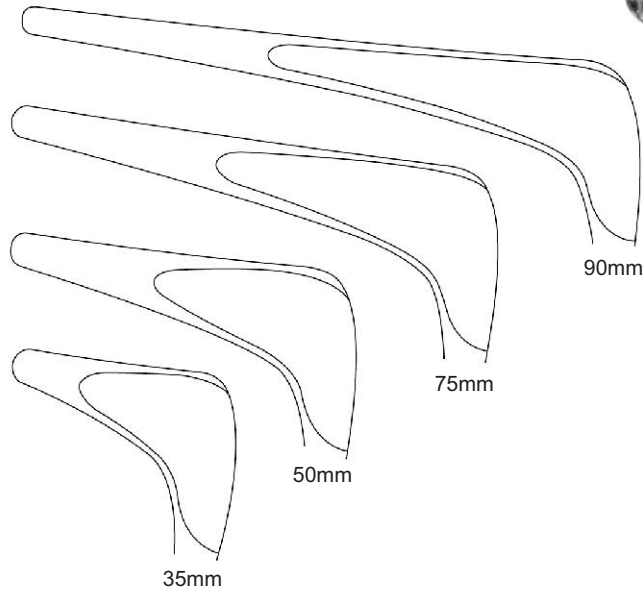

BI 22-6617-35
 BI 22-6617-50
 BI 22-6617-75
 BI 22-6617-90

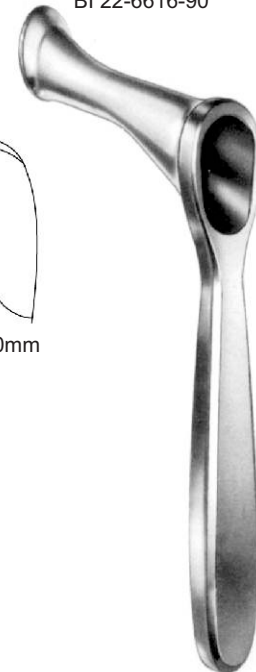

YANKAUER
 BI 22-6618-19
 19.0cm



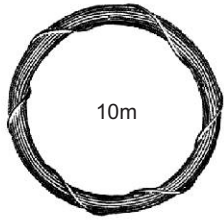

10m

BI 22-6619-03 0.3mm Ø
BI 22-6619-04 0.4mm Ø



BI 22-6620-02 0.2mm Ø
BI 22-6620-03 0.3mm Ø



KRAUSE
BI 22-6621-26
26.0cm

KRAUSE-VOSS
BI 22-6622-26
26.0cm

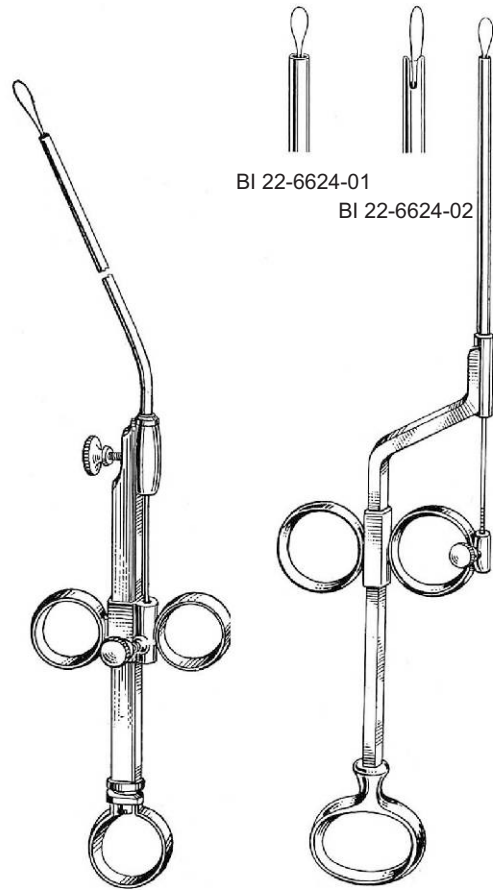

BI 22-6624-01
BI 22-6624-02

KRAUSE
BI 22-6623-00

GLEGG

RHINOLOGY



KILLIAN
 BI 22-6625-17
 17.0cm



LITTAUER
 BI 22-6626-18
 18.0cm

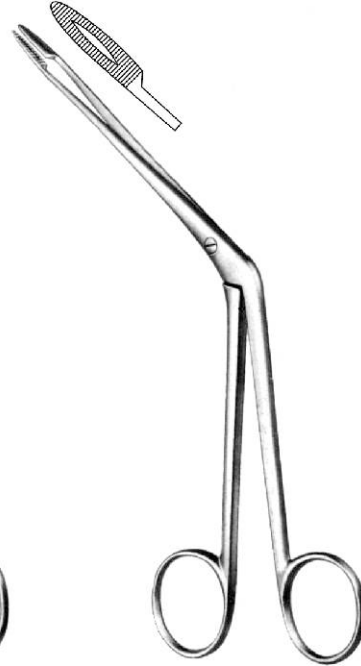

HARTMANN
 BI 22-6627-20
 20.0cm



QUIRE
 BI 22-6628-12
 12.0cm

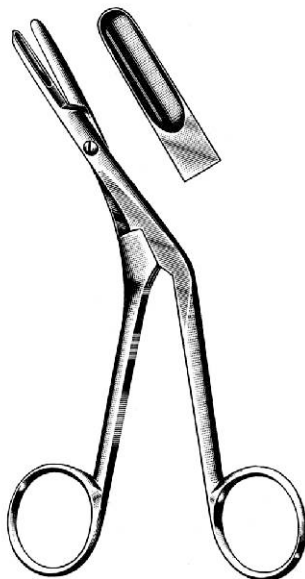

GRAIG
 BI 22-6629-18
 18.0cm



BI 22-6630-01 BI 22-6630-02

18.0cm





KNIGHT
BI 22-6631-18
18.0cm

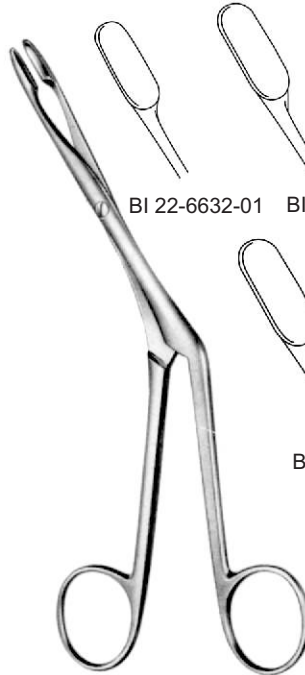

HEYMANN
18.0cm

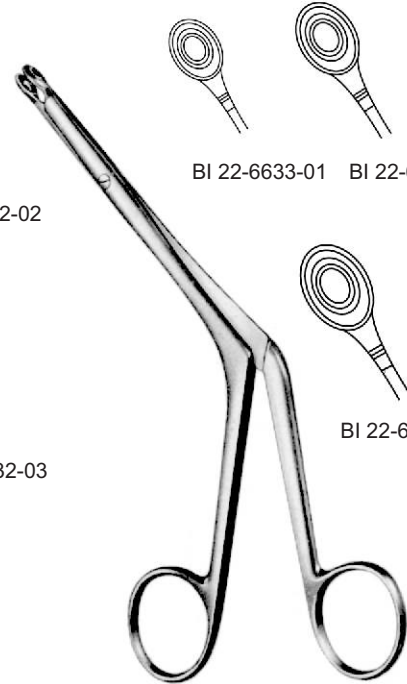

BRUENINGS
19.0cm



LUC
20.0cm

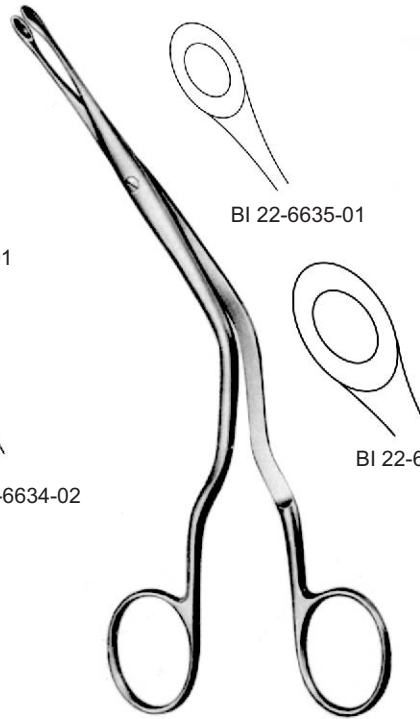

LUC
20.0cm

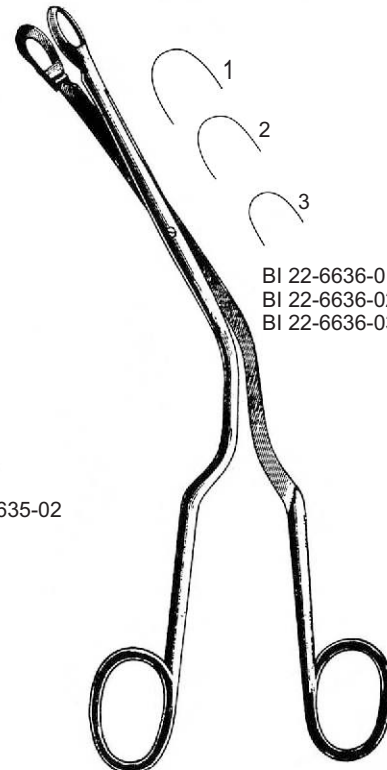

LUC
20.0cm

BI 22-6636-01 Fig. 1
 BI 22-6636-02 Fig. 2
 BI 22-6636-03 Fig. 3

RHINOLOGY

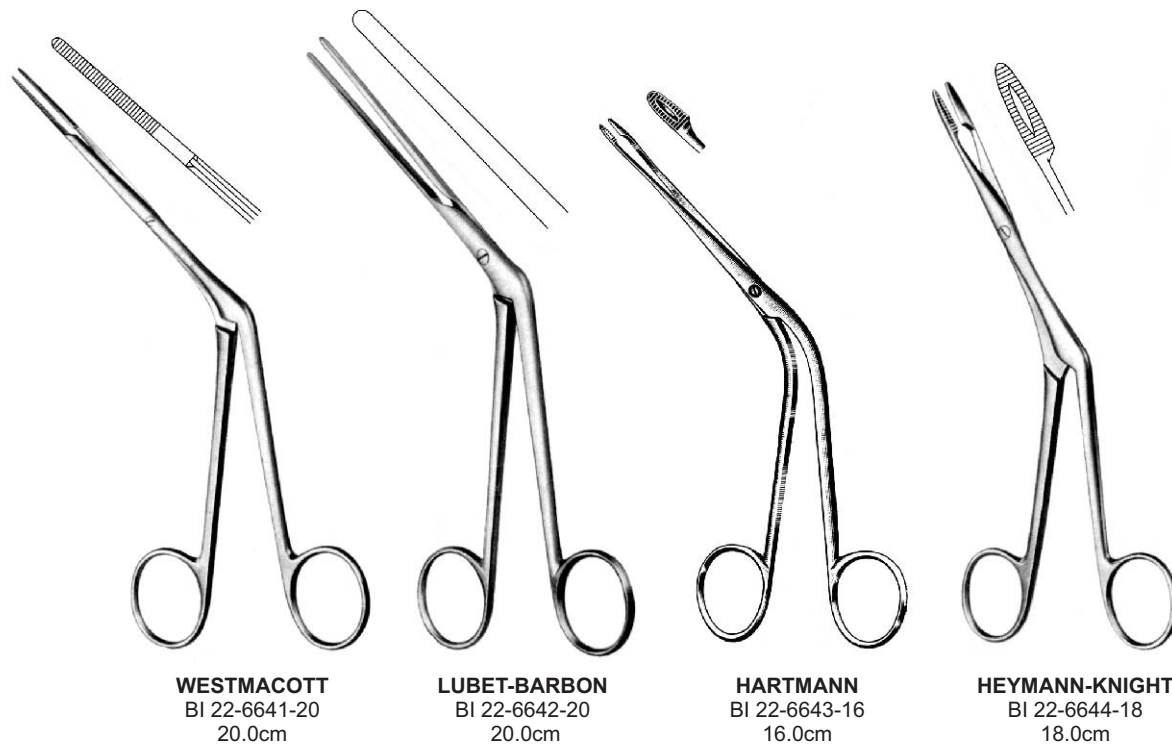
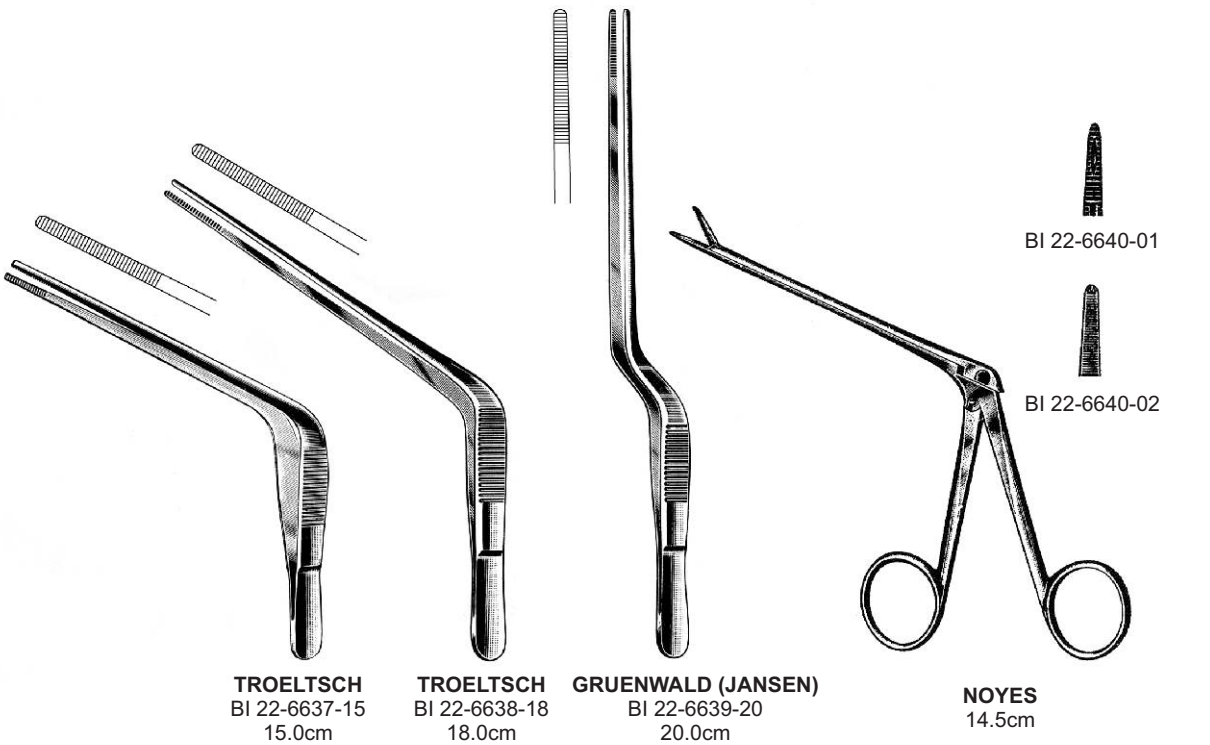

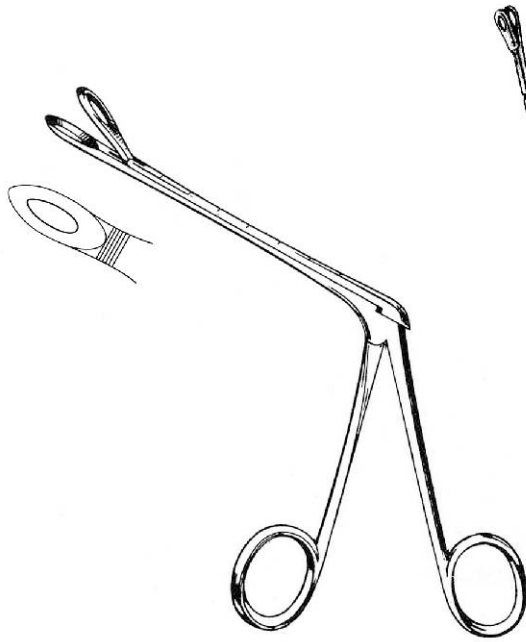

HENCKEL
BI 22-6645-20
20.0cm

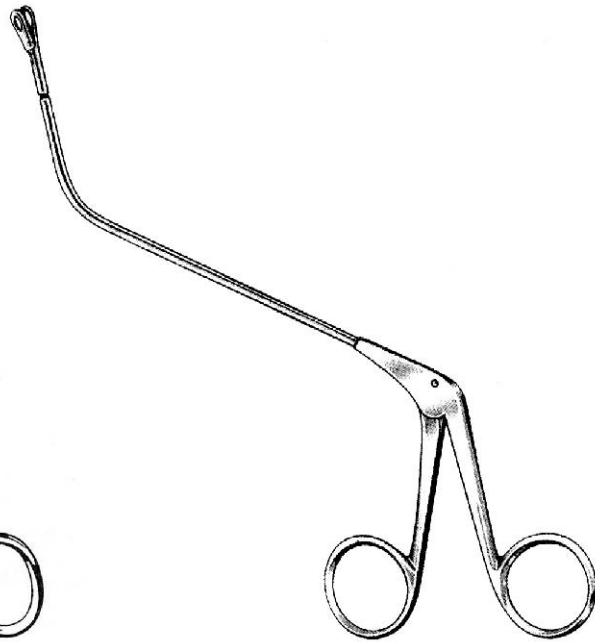

JATHO
BI 22-6646-15

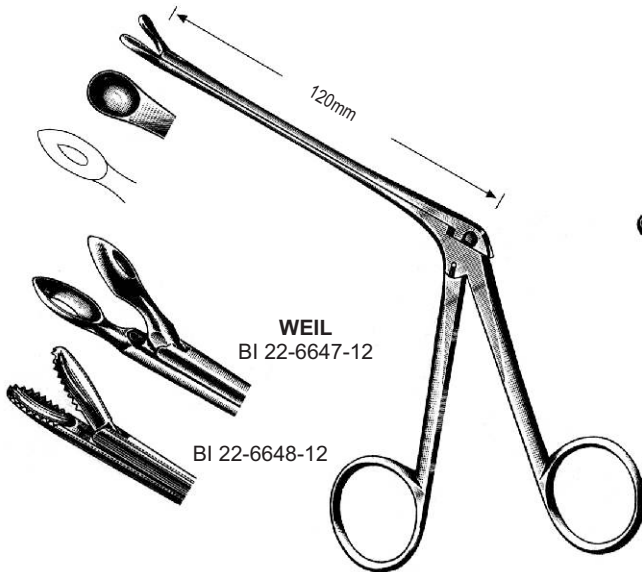

WEIL
BI 22-6647-12

BI 22-6648-12

WATSON-WILLIAMS
BI 22-6648-19
19.0cm

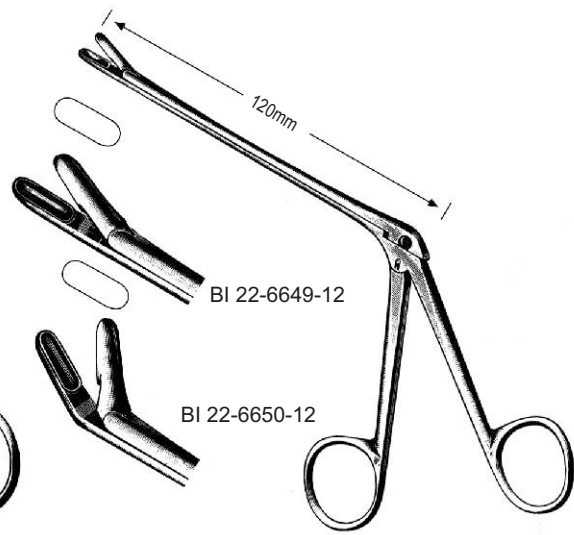

BI 22-6649-12

BI 22-6650-12

TAKAHASHI
19.0cm

RHINOLOGY

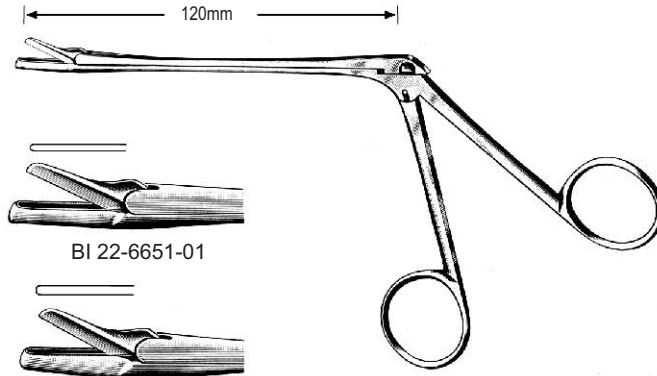

STRUYCKEN
 19.0cm

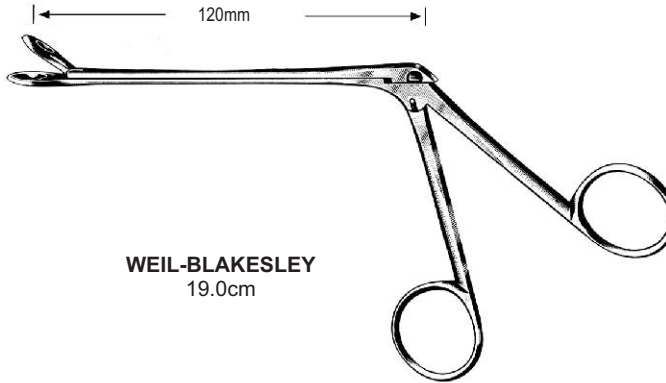

WEIL-BLAKESLEY
 19.0cm

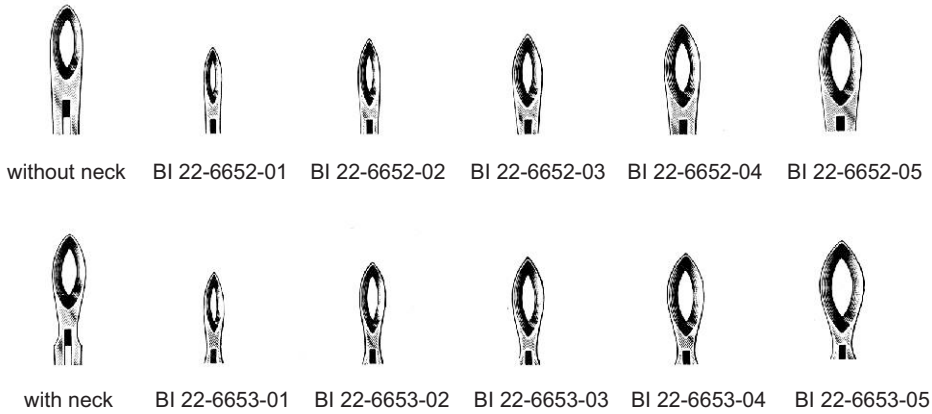

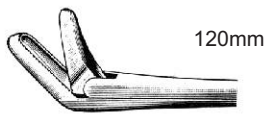
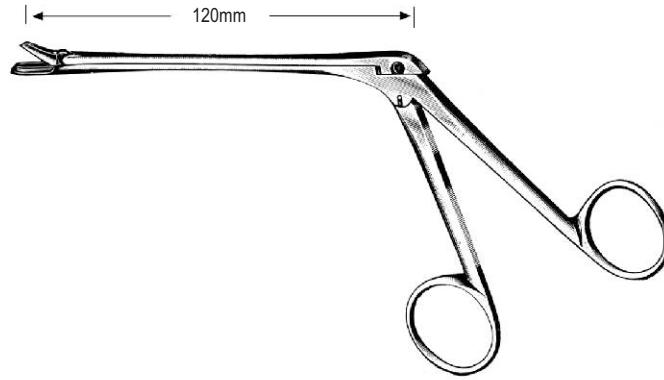

HAJEK
19.0cm

BI 22-6654-12

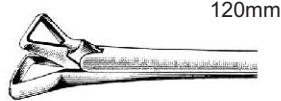

SCHMEDEN
19.0cm

BI 22-6655-12



HARTMANN
19.0cm

BI 22-6656-01 5mm
 BI 22-6656-02 7mm
 BI 22-6656-03 9mm
 BI 22-6656-04 11mm

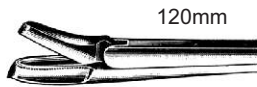

MYLES
19.0 cm

BI 22-6657-01
2.2mm

BI 22-6657-02
2.6mm

BI 22-6658-01

BI 22-6658-02

BI 22-6657-03
3mm

BI 22-6657-04
3.4mm

BI 22-6658-03

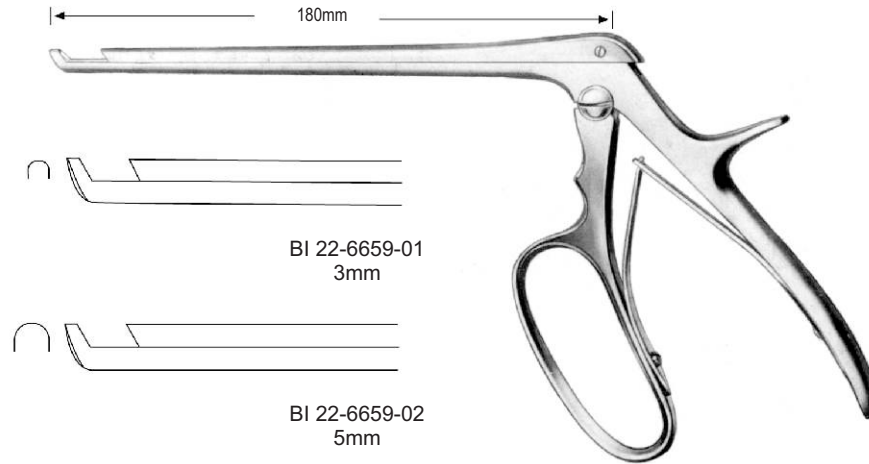

FERRIS-BIITH-KERRISON
 (CLOWARD HARPER)

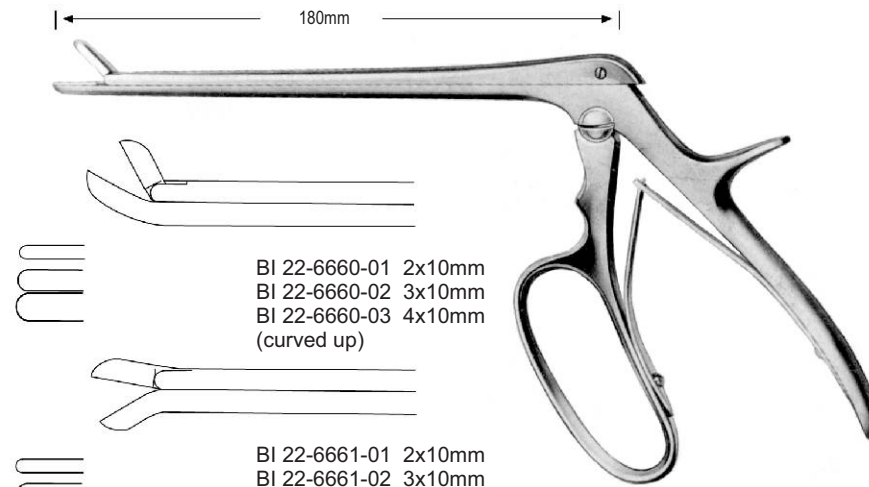

FERRIS-BIITH-CUSHING

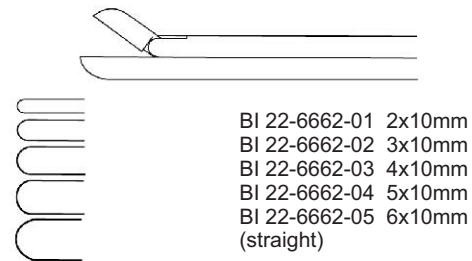

BI 22-6662-01 2x10mm
 BI 22-6662-02 3x10mm
 BI 22-6662-03 4x10mm
 BI 22-6662-04 5x10mm
 BI 22-6662-05 6x10mm
 (straight)



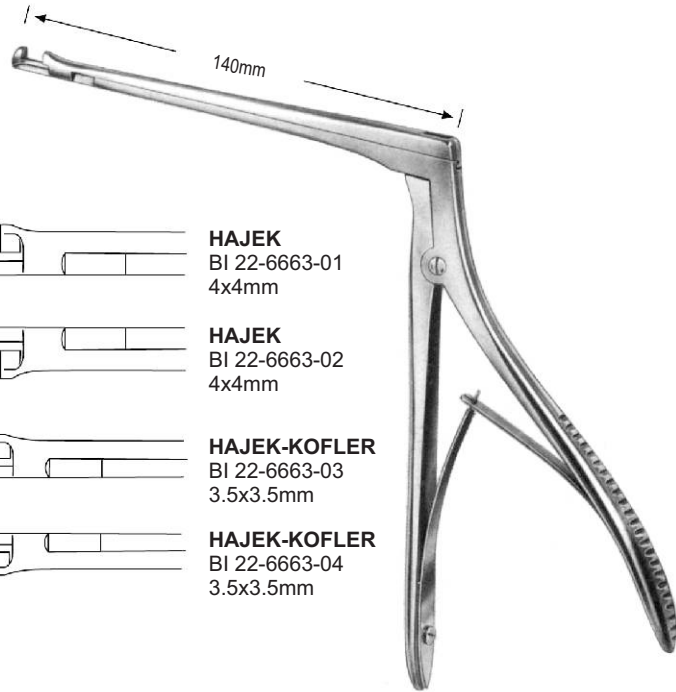

HAJEK
BI 22-6663-01
4x4mm

HAJEK
BI 22-6663-02
4x4mm

HAJEK-KOFLER
BI 22-6663-03
3.5x3.5mm

HAJEK-KOFLER
BI 22-6663-04
3.5x3.5mm

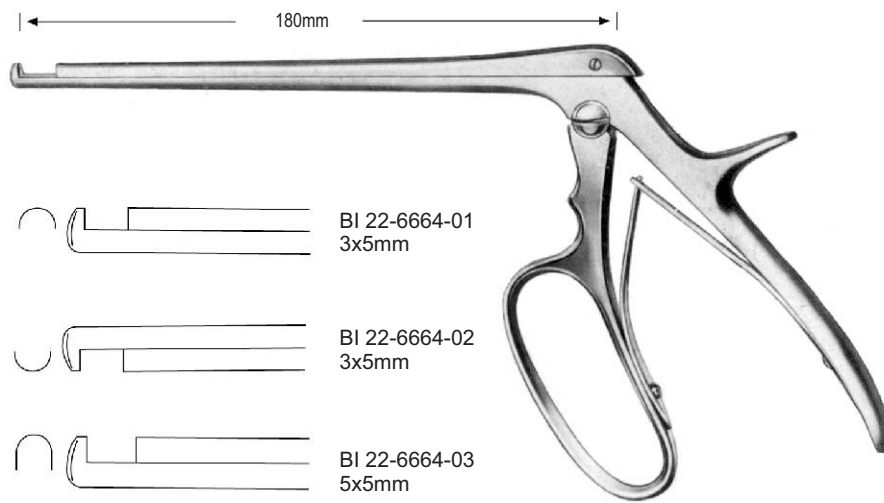

BI 22-6664-01
3x5mm

BI 22-6664-02
3x5mm

BI 22-6664-03
5x5mm

BI 22-6664-04
5x5mm

FERRIS-BIITH-KERRISON

RHINOLOGY



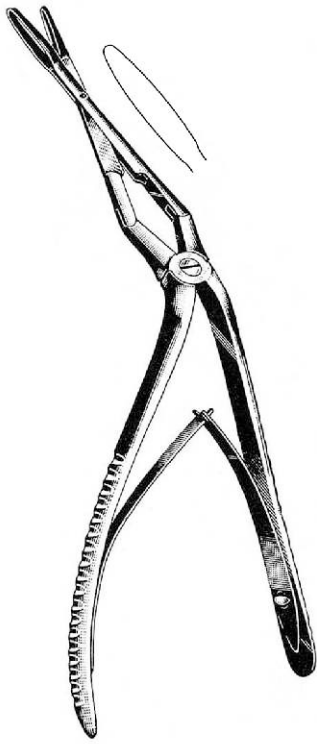

JANSEN-STRUYCKEN
BI 22-6670-19
19.0cm



MIDDLETON-JANSEN
BI 22-6671-19
19.0cm



MIDDLETON-JANSEN
BI 22-6672-19
19.0cm



CAPLAN
BI 22-6673-20
20.0cm

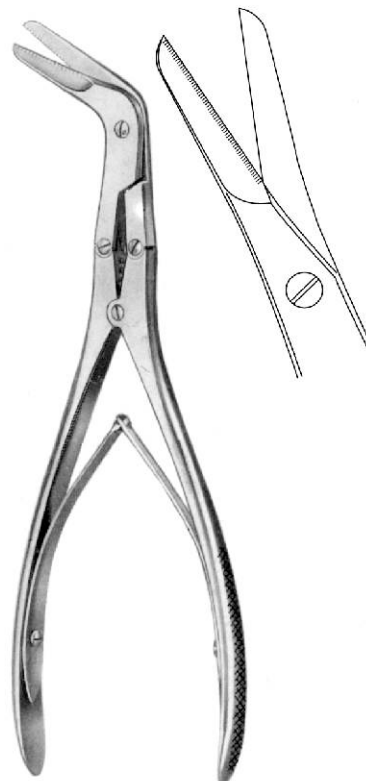

KILLIAN
BI 22-6674-21
21.0cm



RUBIN
BI 22-6675-21
21.0cm

RHINOLOGY

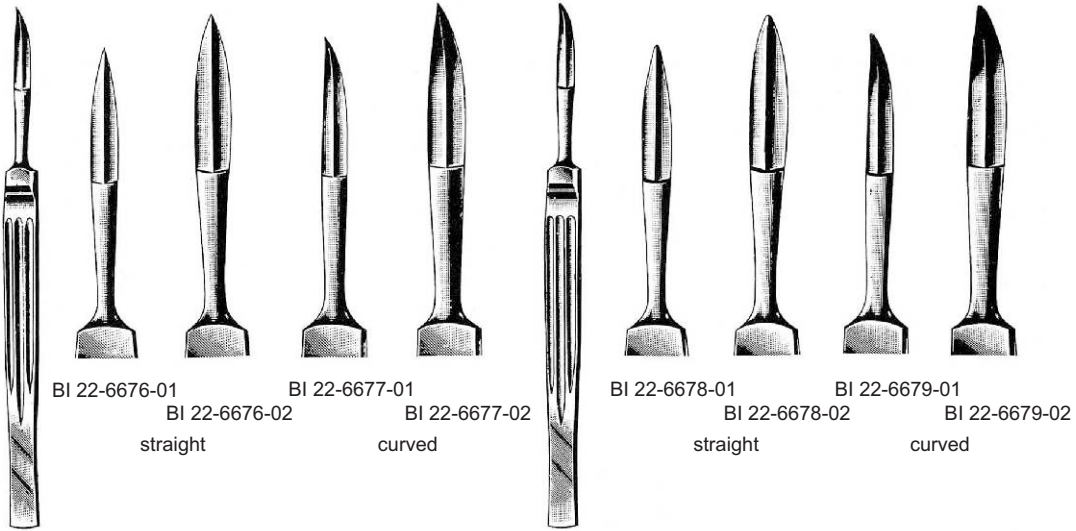

JOSEPH (sharp)
15.0cm

JOSEPH (blunt)
15.0cm

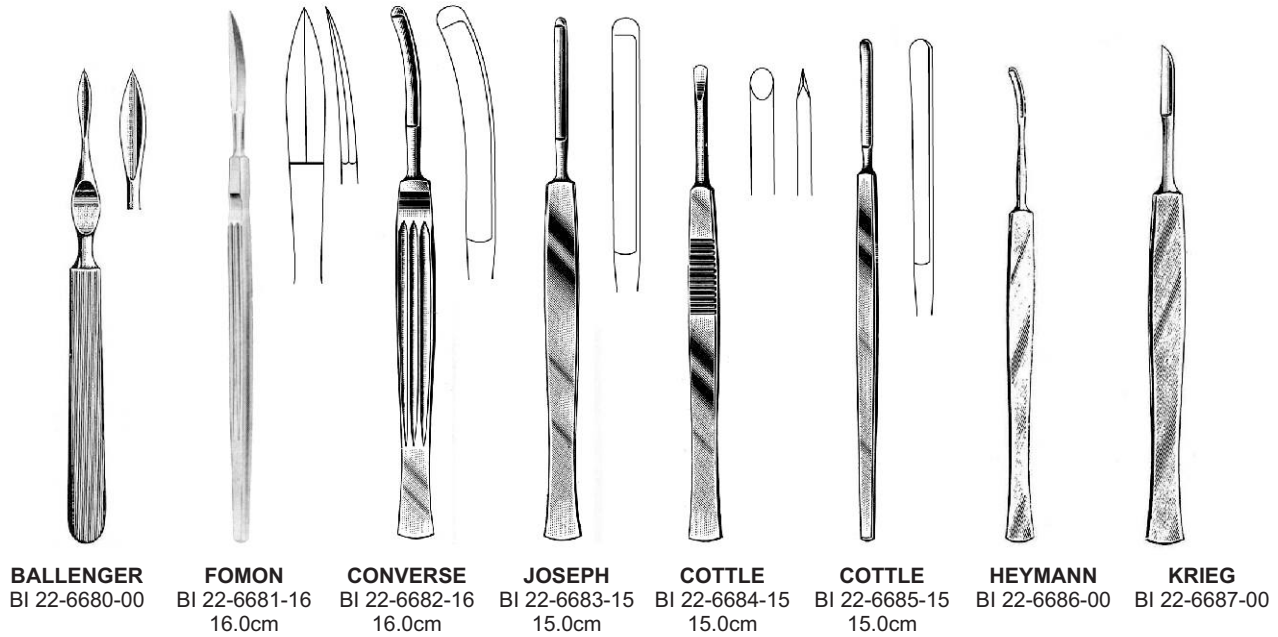

BALLENGER
BI 22-6680-00

FOMON
BI 22-6681-16
16.0cm

CONVERSE
BI 22-6682-16
16.0cm

JOSEPH
BI 22-6683-15
15.0cm

COTTLE
BI 22-6684-15
15.0cm

COTTLE
BI 22-6685-15
15.0cm

HEYMANN
BI 22-6686-00

KRIEG
BI 22-6687-00





BALLENGER
20.0cm



BI 22-6688-03
3mm

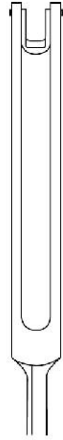

BI 22-6688-04
4mm

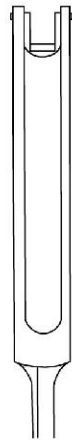

BI 22-6688-05
5mm



BALLENGER
20.0cm

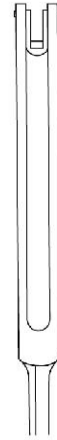

BI 22-6689-03
3mm

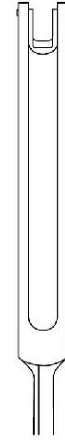

BI 22-6689-04
4mm



BI 22-6689-05
5mm



BRUENINGS
BI 22-6690-16
16.5cm



FREER
BI 22-6691-00



FREER
BI 22-6692-15
15.0cm

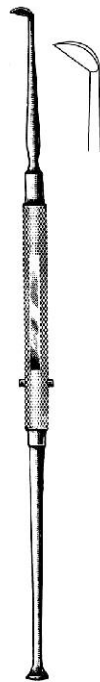

FREER
BI 22-6693-19
19.0cm



FREER
BI 22-6694-19
19.0cm

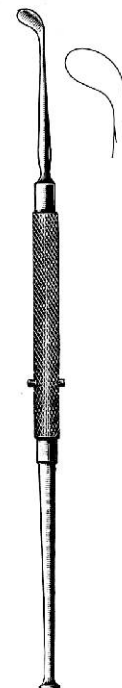

FREER
BI 22-6695-19
19.0cm



FREER
BI 22-6696-19
19.0cm

RHINOLOGY

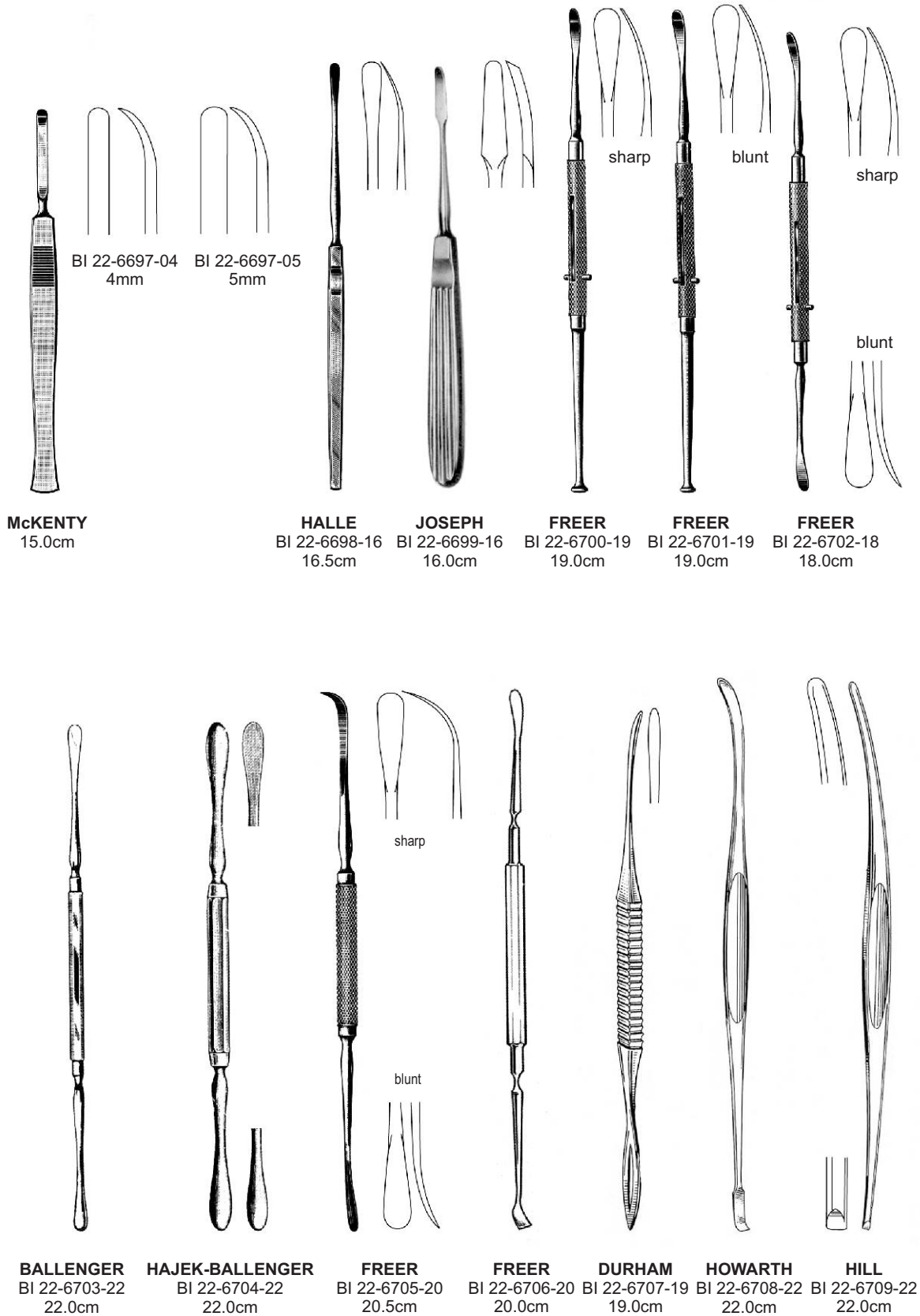

McKENY
15.0cm

BI 22-6697-04
4mm

BI 22-6697-05
5mm

HALLE
BI 22-6698-16
16.5cm

JOSEPH
BI 22-6699-16
16.0cm

FREER
BI 22-6700-19
19.0cm

FREER
BI 22-6701-19
19.0cm

FREER
BI 22-6702-18
18.0cm

BALLENGER
BI 22-6703-22
22.0cm

HAJEK-BALLENGER
BI 22-6704-22
22.0cm

FREER
BI 22-6705-20
20.5cm

FREER
BI 22-6706-20
20.0cm

DURHAM
BI 22-6707-19
19.0cm

HOWARTH
BI 22-6708-22
22.0cm

HILL
BI 22-6709-22
22.0cm



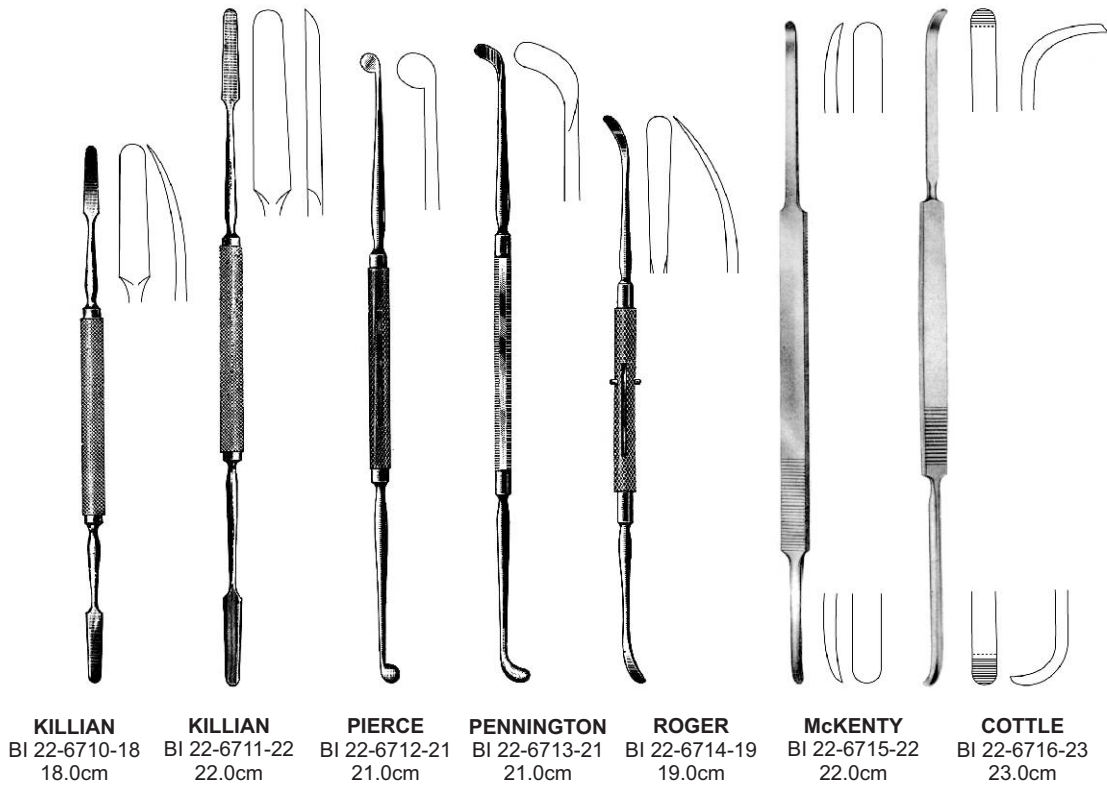

RHINOLOGY

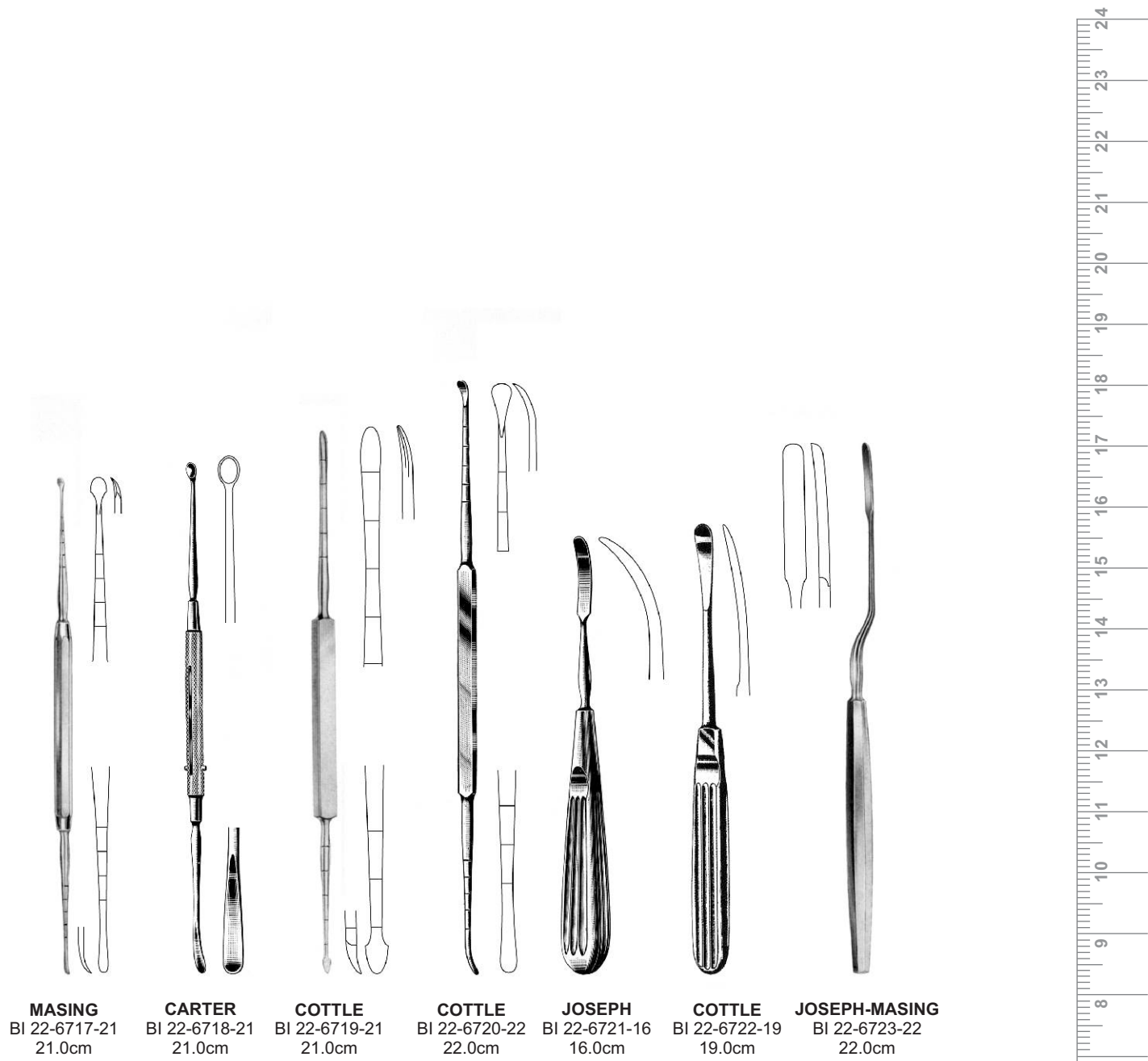

MASING
 BI 22-6717-21
 21.0cm

CARTER
 BI 22-6718-21
 21.0cm

COTTLE
 BI 22-6719-21
 21.0cm

COTTLE
 BI 22-6720-22
 22.0cm

JOSEPH
 BI 22-6721-16
 16.0cm

COTTLE
 BI 22-6722-19
 19.0cm

JOSEPH-MASING
 BI 22-6723-22
 22.0cm



KILLIAN
BI 22-6724-17
17.0cm



KILLIAN-CLAUS
BI 22-6725-17
17.0cm



BI 22-6726-04
4mm
BI 22-6726-06
6mm
BI 22-6726-08
8mm

BALLENGER



FREER
BI 22-6727-15
15.0cm



WEST
BI 22-6728-16
16.0cm



WEST
BI 22-6729-16
16.0cm

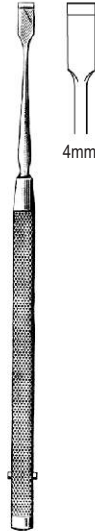

FREER
BI 22-6730-16



FREER
BI 22-6731-16



FREER

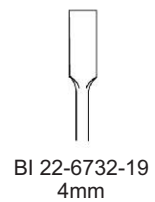

BI 22-6732-19
4mm

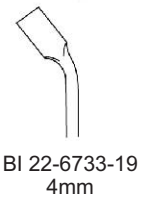

BI 22-6733-19
4mm

RHINOLOGY

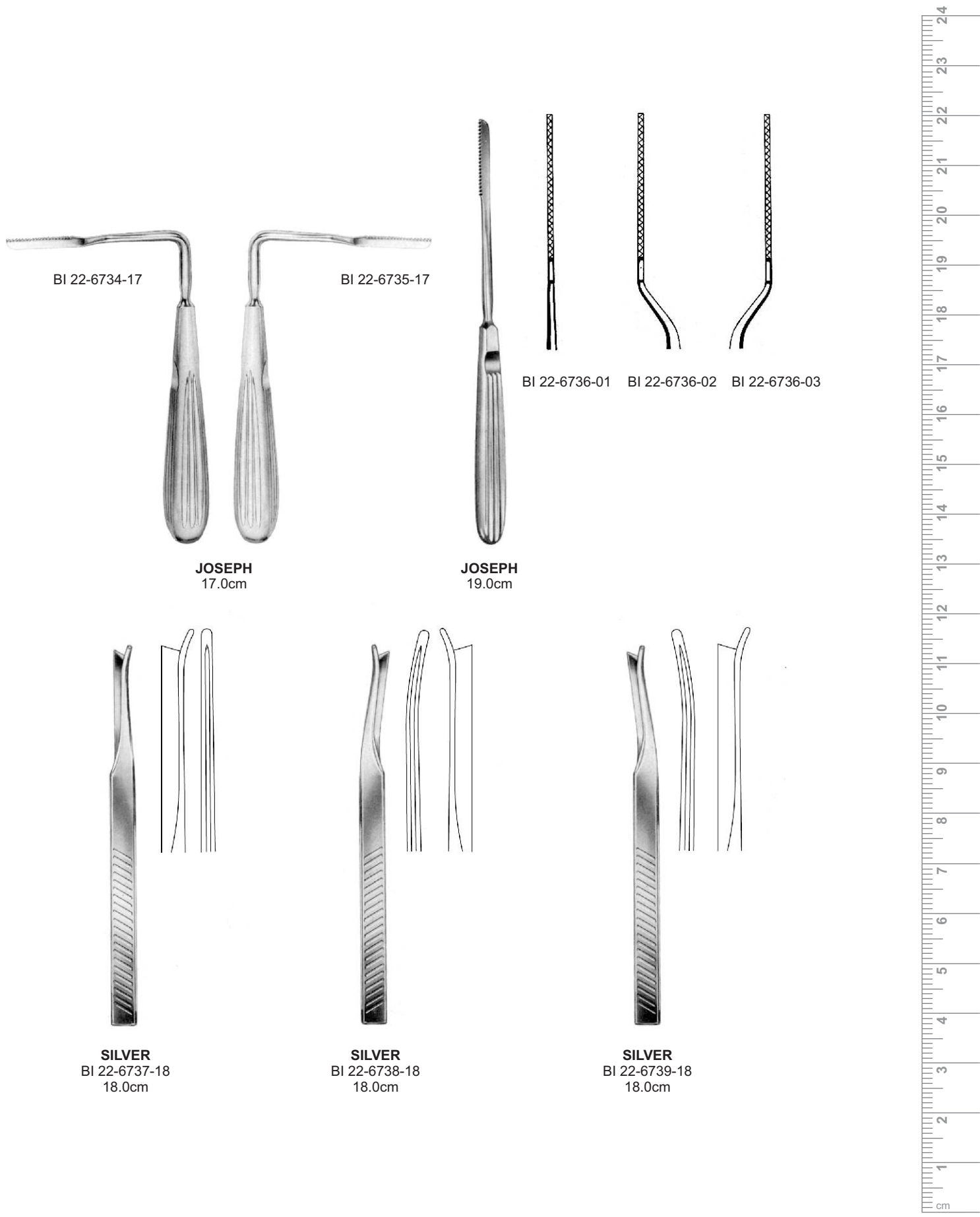

BI 22-6734-17

BI 22-6735-17

BI 22-6736-01

BI 22-6736-02

BI 22-6736-03

JOSEPH
17.0cm

JOSEPH
19.0cm

SILVER
BI 22-6737-18
18.0cm

SILVER
BI 22-6738-18
18.0cm

SILVER
BI 22-6739-18
18.0cm

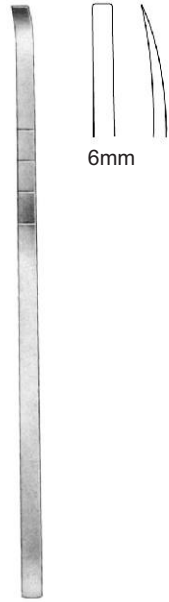

6mm

COTTLE
BI 22-6740-18
18.0cm



BI 22-6741-04
4mm

BI 22-6741-07
7mm

BI 22-6741-09
9mm

BI 22-6741-12
12mm

COTTLE
18.0cm

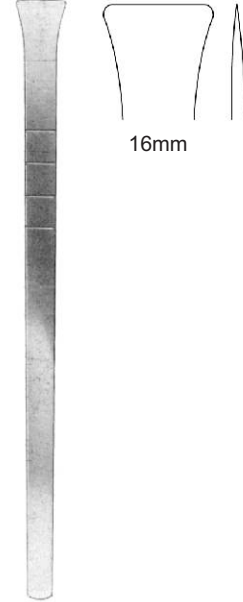

16mm

COTTLE
BI 22-6742-18
18.0cm

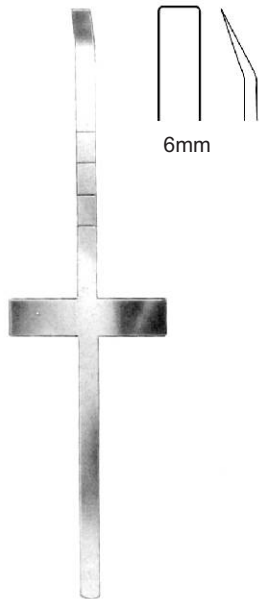

6mm

COTTLE
BI 22-6743-18
18.0cm

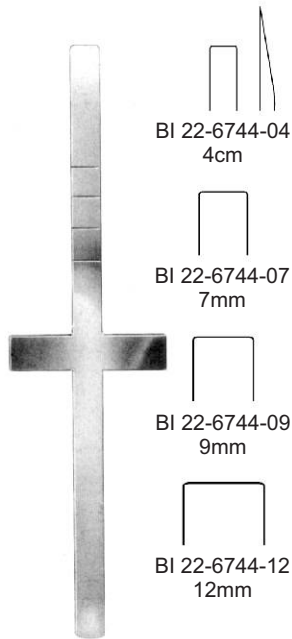

BI 22-6744-04
4cm

BI 22-6744-07
7mm

BI 22-6744-09
9mm

BI 22-6744-12
12mm

COTTLE
18.0cm

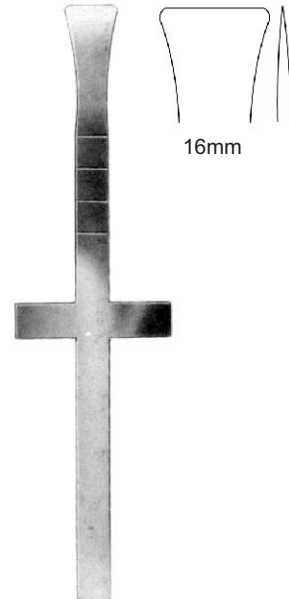

16mm

COTTLE
BI 22-6745-18
18.0cm

RHINOLOGY

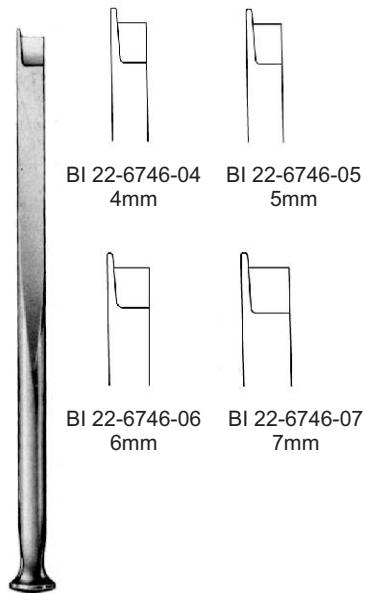

FOMON
17.0cm

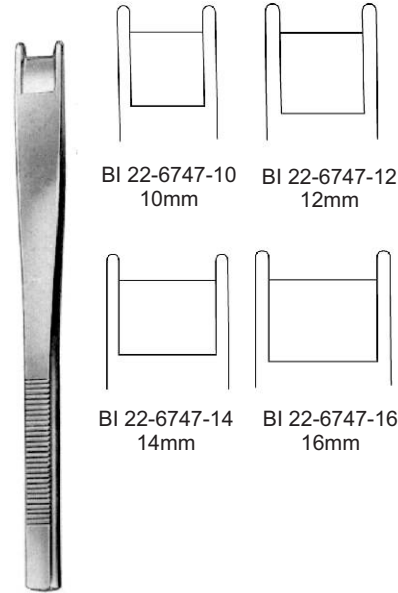

CINELLI
16.0cm

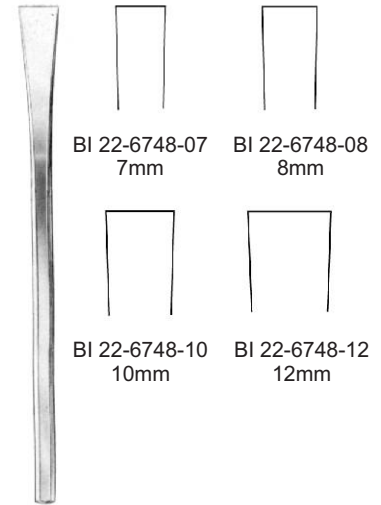

SHEEHAN
17.0cm

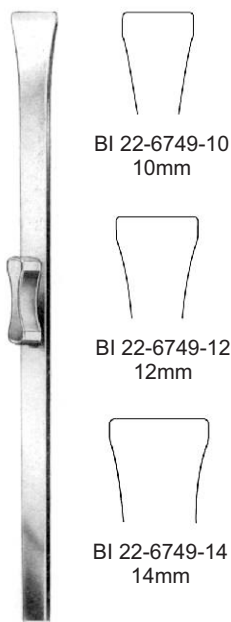

RUBIN
18.0cm

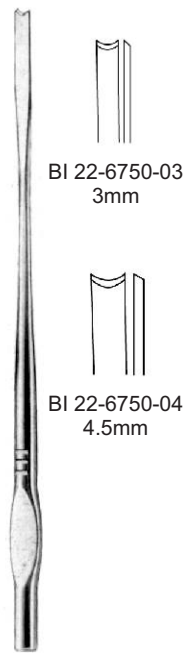

WALTER
19.0cm

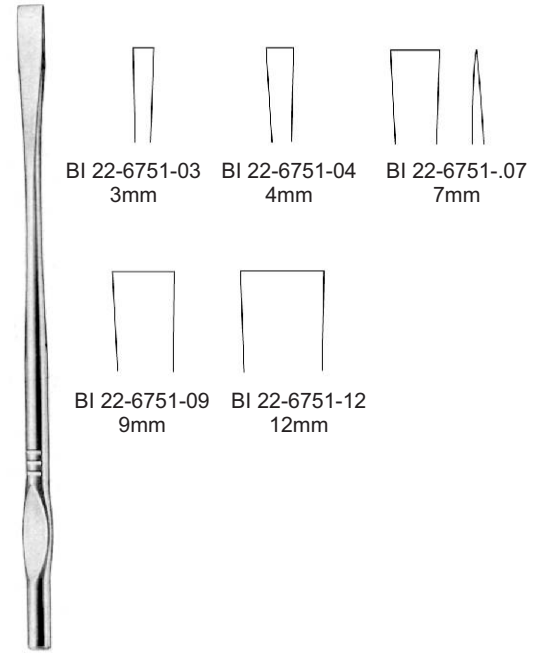

WALTER
19.0cm



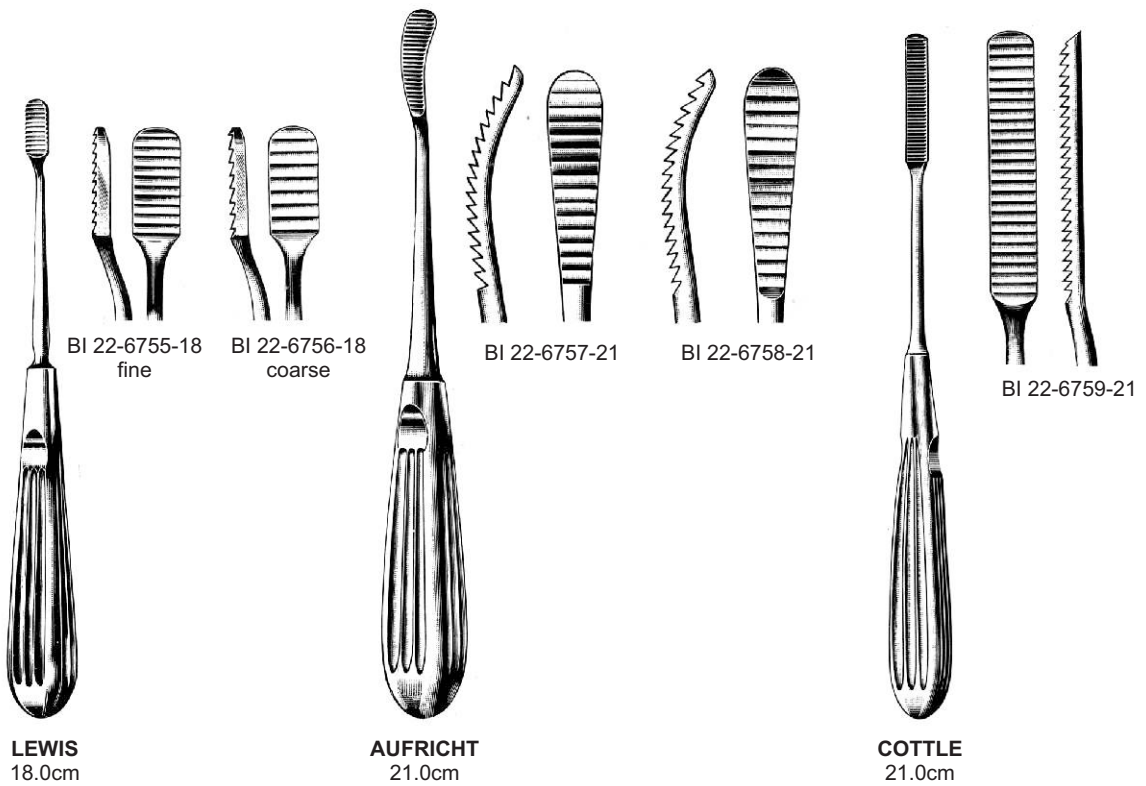
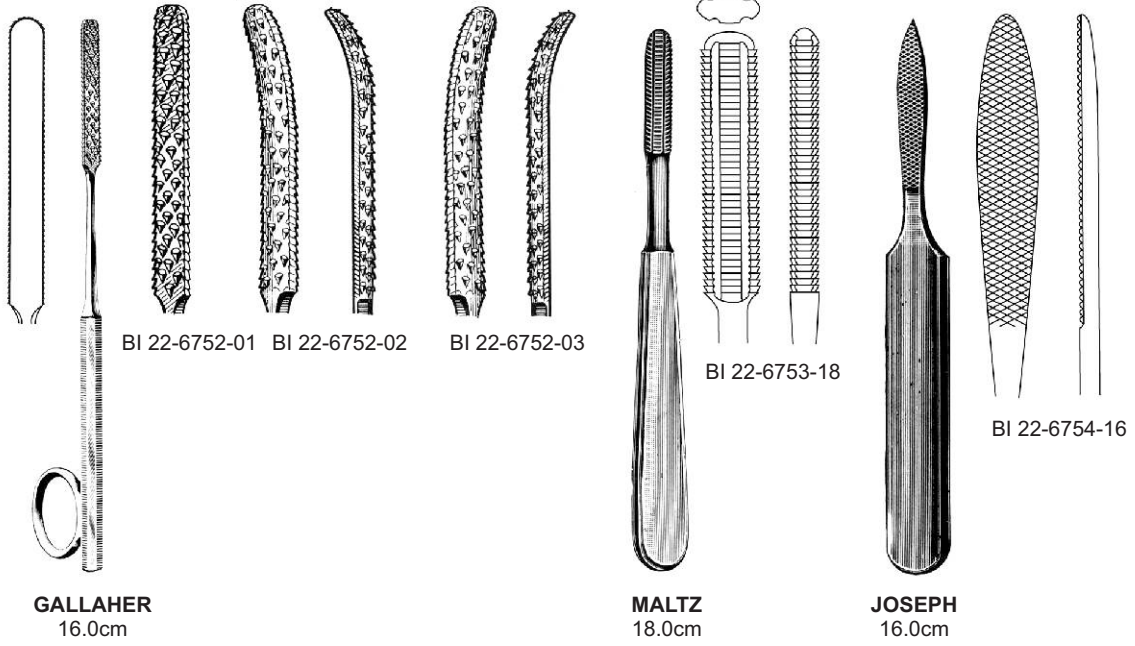

RHINOLOGY



WIENER
 18.0cm

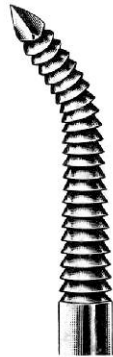

BI 22-6760-18



BI 22-6761-18

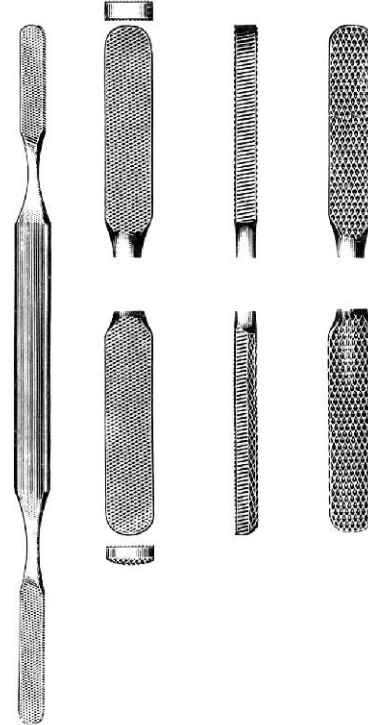

FOMON
 BI 22-6762-21
 21.0cm



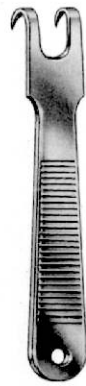

KILNER
BI 22-6763-10
10.0cm



CONVERSE
BI 22-6764-12
12.0cm

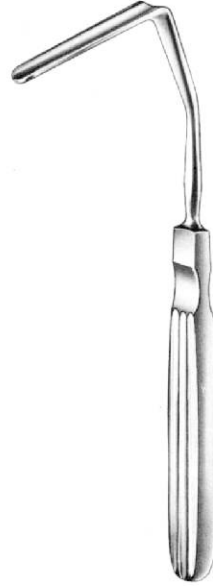

AUFRICHT
BI 22-6765-16
16.0cm

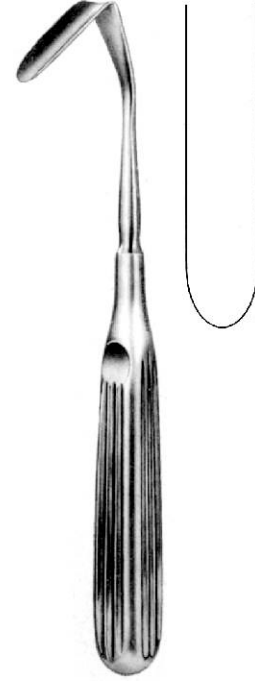

AUFRICHT
BI 22-6766-19
19.0cm



15.0cm



BI 22-6767-01



BI 22-6767-02



BI 22-6767-03



LANGE
BI 22-6768-22
22.0cm



FOMON
BI 22-6769-17
17.0cm



COTTLE
BI 22-6770-16
16.0cm



FREER
BI 22-6771-15
15.0cm



RHINOLOGY



OGURA
 BI 22-6772-11
 11.0cm



COTTLE
 BI 22-6773-11
 11.0cm



COTTLE
 BI 22-6774-14
 14.0cm



COTTLE
 15.0cm

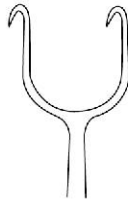

BI 22-6775-14

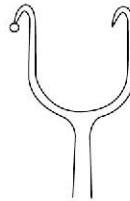

BI 22-6775-01

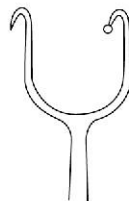

BI 22-6775-02



FOMON
 BI 22-6776-16
 16.0cm

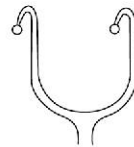

COTTLE-NEIVERT
 BI 22-6777-20
 20.0cm

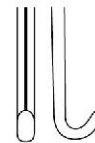



BI 22-6778-01 BI 22-6778-02 BI 22-6778-03 BI 22-6778-04 BI 22-6778-05



BI 22-6778-06 BI 22-6778-07 BI 22-6778-08 BI 22-6778-09



YANKAUER



COTTLE
BI 22-6779-14
14.0cm



NEIVERT
BI 22-6780-16
16.0cm



COTTLE
BI 22-6781-15
15.0cm



COTTLE
BI 22-6782-15
15.0cm



AUFRICHT
BI 22-6783-13
13.5cm



COAKLEY
 17.0cm

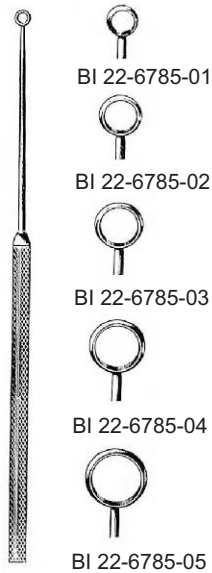
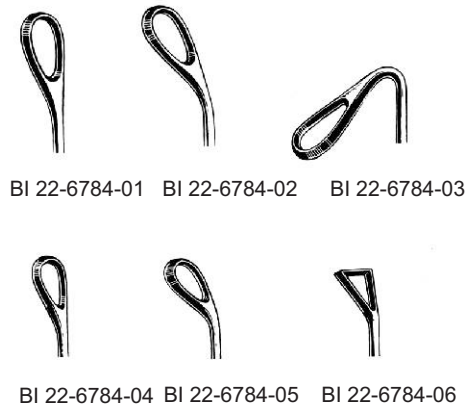

MYLES
 17.0cm

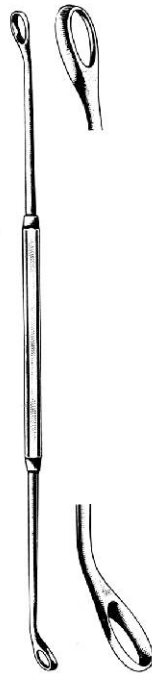

BI 22-6786-12
 12.0cm

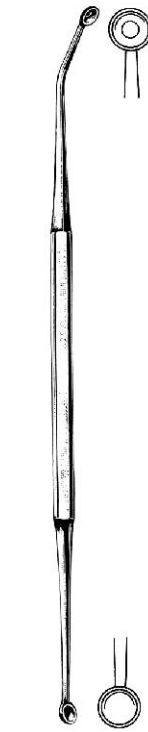

PRATT
 BI 22-6787-21
 21.0cm

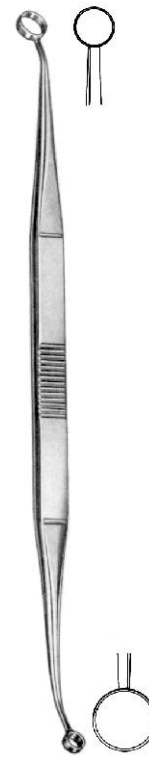

FAULKNER
 BI 22-6788-21
 21.0cm





KRESSNER
BI 22-6789-20
20.0cm

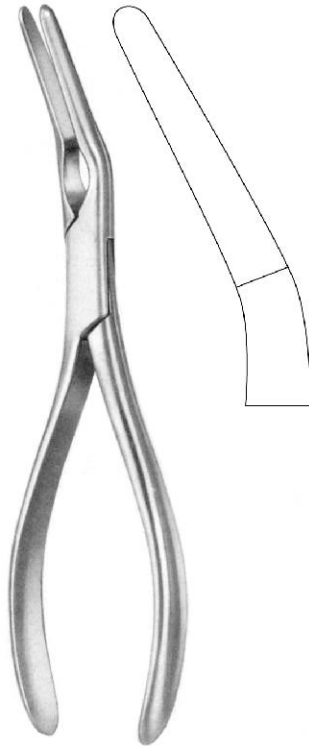

ASCH
BI 22-6790-23
23.0cm



BI 22-6791-23
straight

BI 22-6792-23
left

BI 22-6793-23
right



COTTLE-WALSHAM
23.0cm



BECKMANN
22.0cm



BECKMANN
22.0cm



BI 22-6794-01
BI 22-6795-01



BI 22-6794-02
BI 22-6795-02

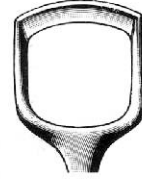

BI 22-6794-03
BI 22-6795-03



BI 22-6794-04
BI 22-6795-04

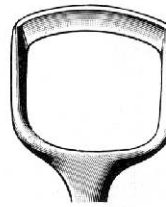

BI 22-6794-05
BI 22-6795-05

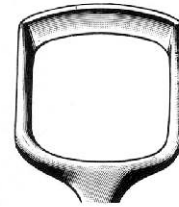

BI 22-6794-06
BI 22-6795-06



BECKMANN
22.0cm



BI 22-6796-01

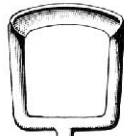

BI 22-6796-02

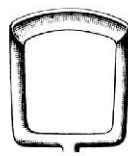

BI 22-6796-03

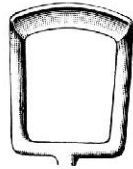

BI 22-6796-04

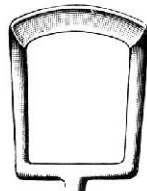

BI 22-6796-05



ST. CLAIR-THOMSON
21.0cm



BI 22-6797-08
8mm

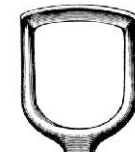

BI 22-6797-10
10mm



BI 22-6797-12
12mm

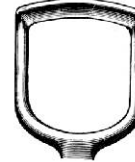

BI 22-6797-14
14mm



BI 22-6797-16
16mm

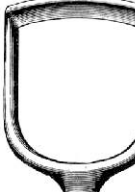

BI 22-6797-18
18mm





BRUENINGS-BRUNK
BI 22-6798-21
21.5cm



LA FORCE
25.0cm

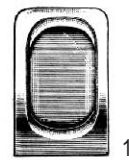

with unperforated blade
BI 22-6799-01 Fig. 1
BI 22-6799-02 Fig. 2
BI 22-6799-03 Fig. 3

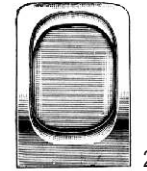

spare blades
BI 22-6801-01 Fig. 1
BI 22-6801-02 Fig. 2
BI 22-6801-03 Fig. 3

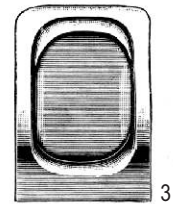

with perforated blade
BI 22-6800-01
BI 22-6800-02
BI 22-6800-03

BI 22-6802-01
BI 22-6802-02
BI 22-6802-03

RHINOLOGY

with screw

BI 22-6803-15 1.5mm Ø
 BI 22-6803-17 1.7mm Ø
 BI 22-6803-20 2.0mm Ø
 BI 22-6803-25 2.5mm Ø
 BI 22-6803-30 3.0mm Ø

BI 22-6804-15 1.5mm Ø
 BI 22-6804-17 1.7mm Ø
 BI 22-6804-20 2.0mm Ø
 BI 22-6804-25 2.5mm Ø
 BI 22-6804-30 3.0mm Ø

SIEBENMANN
 15.0cm

GULEN
 BI 22-6805-20 20.0cm

RITTER-HALLE
 BI 22-6806-25 2.5mm Ø
 BI 22-6806-30 3.0mm Ø
 BI 22-6806-45 4.5mm Ø

BELLOCQ
 BI 22-6807-14 14.0cm

HAJEK
 BI 22-6808-15 1.5mm Ø
 BI 22-6808-20 2.0mm Ø

MYLES
 BI 22-6809-09 9.0cm
 BI 22-6809-11 11.5cm
 1.8mm Ø

HARTMANN
 BI 22-6810-20 2.0mm Ø
 BI 22-6810-25 2.5mm Ø
 BI 22-6810-30 3.0mm Ø

HARTMANN
 BI 22-6811-20 2.0mm Ø
 BI 22-6811-25 2.5mm Ø
 BI 22-6811-30 3.0mm Ø

HARTMANN
 BI 22-6812-20 2.0mm Ø
 BI 22-6812-25 2.5mm Ø
 BI 22-6812-30 3.0mm Ø

EICKEN-KILLIAN
 BI 22-6813-14 14.0cm, 3mm Ø

EICKEN-KILLIAN
 BI 22-6814-14 14.0cm, 3mm Ø

KILLIAN
 BI 22-6815-17 17.0cm, 1.5mm Ø

cm