

20

- EN** Tonsil
- DE** Mandel
- ES** Amígdala
- FR** Amygdale
- IT** Tonsilla

Page 499 to 511

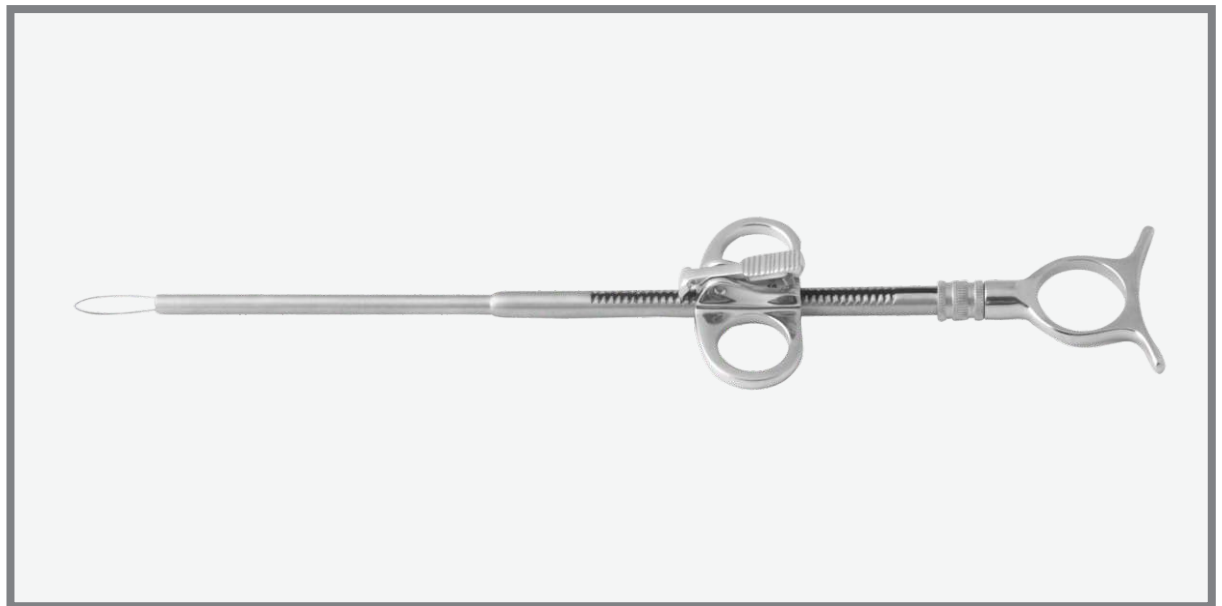



Luniatschek
BI 20-6151-19
19 cm



Luniatschek
BI 20-6152-19
19 cm

Gauze Packers



Day
BI 20-6153-21
21.5 cm



Hurd
BI 20-6154-01
21 cm



Hurd
BI 20-6154-02
21 cm



Nager
BI 20-6155-24
24 cm/9 "



Falk
BI 20-6156-24
24 cm/9 "



Falk
BI 20-6157-24
24 cm/9 "



Claus-Eicken
BI 20-6158-23
23 cm/9"



DURHAM
BI 20-6159-01 25.0cm BI 20-6159-02





ROTTER
 BI 20-6160-01 26.0cm BI 20-6160-02

Fischer
 BI 20-6161-22
 22.5 cm/8⁷/₈"

Douglas
 BI 20-6162-21
 21 cm/8¹/₄"

Abraham
 BI 20-6163-21
 21 cm/8¹/₄"

Bruenings
 BI 20-6164-23
 23 cm/9"

Tydins
 BI 20-6165-21
 21 cm

Canfield
 BI 20-6166-21
 21 cm/8¹/₄"

Colver
 BI 20-6167-22
 22.5cm

Dupy-Weiss
 BI 20-6168-01 22.0cm BI 20-6168-02

Lynch
 BI 20-6169-20
 20.0cm

Carpenter
 BI 20-6170-25
 25.0cm

Carpenter
 BI 20-6171-24
 24.0cm

Marschik
 BI 20-6172-22
 22.0cm



Negus Knot Tier and Pusher
 BI 20-6173-20
 20cm/8"



Molison Pillar
 double ended
 BI 20-6174-21
 21cm/8 1/4"



Gwynee Evans Dissector
 double ended
 BI 20-6175-06
 6mm, 20cm/8"
 BI 20-6175-08
 8mm, 20cm/8"



Hurd
 BI 20-6176-22
 22.5 cm/8 7/8"



Yankauer
 BI 20-6177-21
 21 cm/8 1/4"

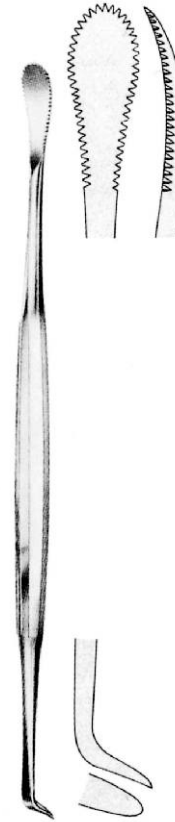

BI 20-6178-01

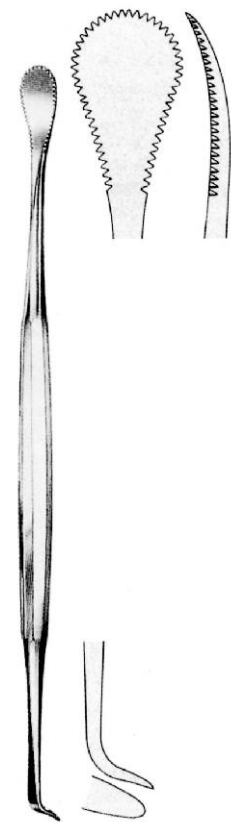

Henke
 23 cm/9"

BI 20-6178-02



Nager
 BI 20-6179-23
 23 cm/9"



Wide
 BI 20-6180-18 18 mm
 BI 20-6180-20 20 mm
 BI 20-6180-22 22 mm

Love
 23 cm/9"

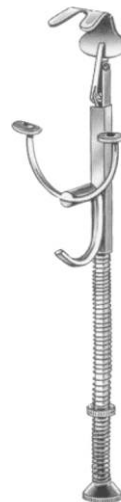

Haslinger
 BI 20-6181-16



Hofer
 BI 20-6182-24
 24 cm/9 1/2"

Tonsil

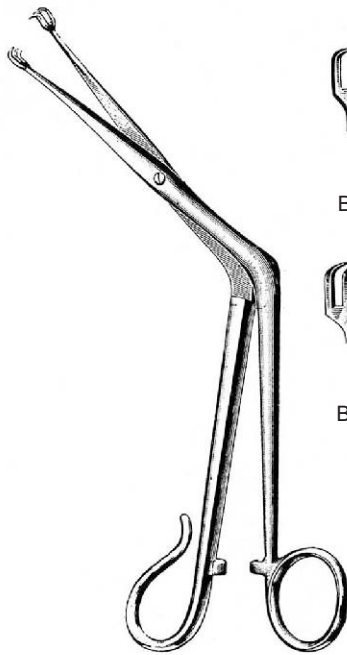

TIVNEN-TYDING
 21.0cm



Fig. 1
 BI 20-6183-01

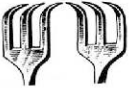
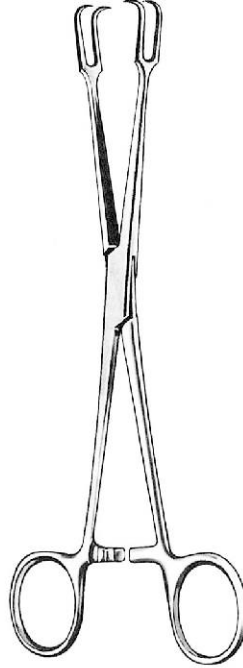
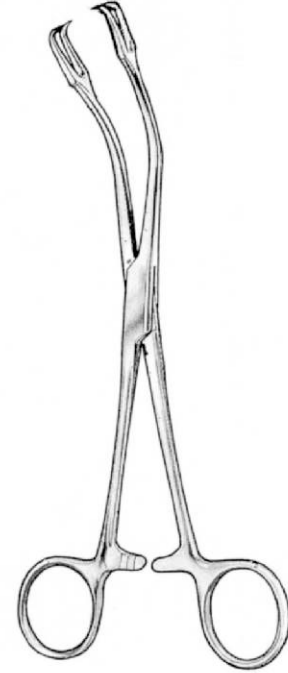

Fig. 2
 BI 20-6183-02



MUSEUX
 BI 20-6184-20
 20.0cm



MUSEUX
 BI 20-6185-20
 20.0cm

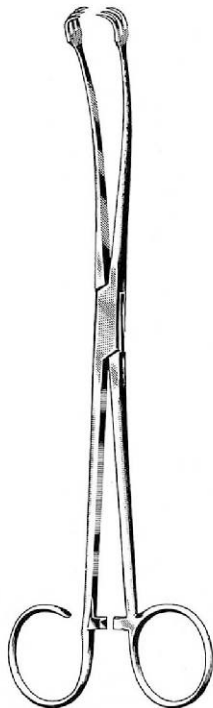

BALLENGER
 BI 20-6186-21
 21.5cm



WHITE
 BI 20-6187-18 18.0cm
 BI 20-6187-23 23.0cm



BI 20-6188-01



BI 20-6188-02

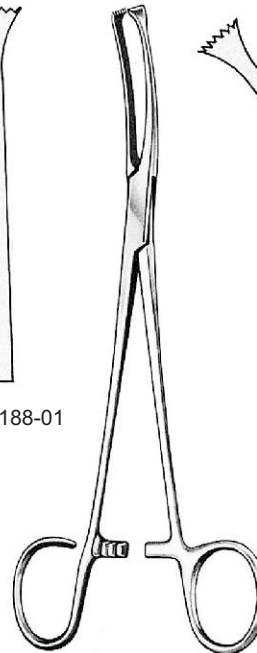

COLVER
 19.0cm



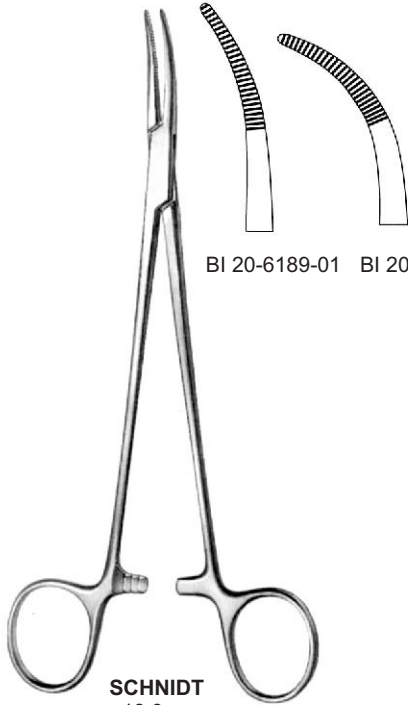

BI 20-6189-01 BI 20-6189-02

SCHNIDT
19.0cm

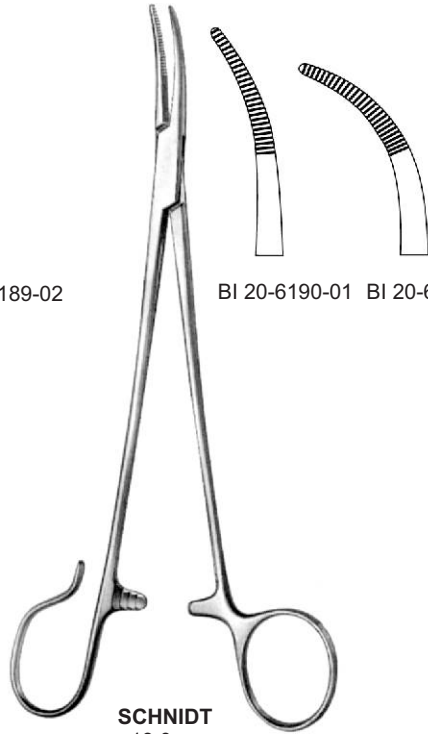

BI 20-6190-01 BI 20-6190-02

SCHNIDT
19.0cm

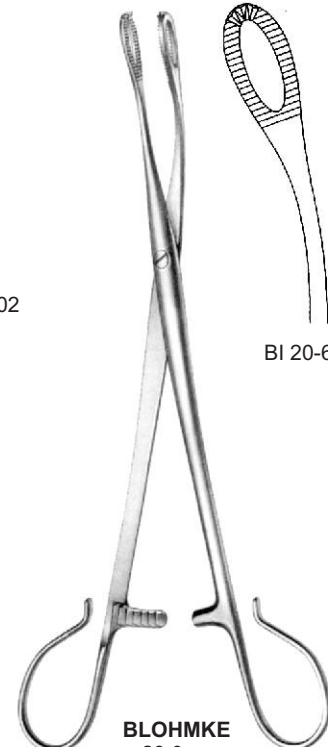

BI 20-6191-20

BLOHMKE
20.0cm



DENIS-BROWNE
BI 20-6192-18 18.0cm
BI 20-6192-21 21.0cm

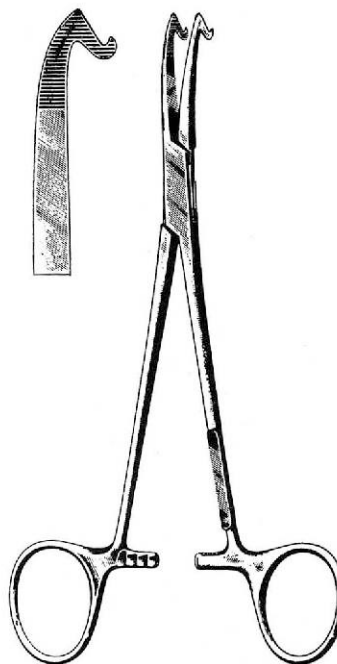

McWHORTER-LOTHROP
BI 20-6193-18
18.0cm

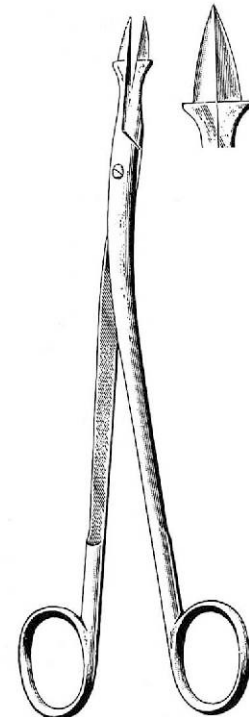

THILENIUS
BI 20-6194-20
20.0cm

Tonsil

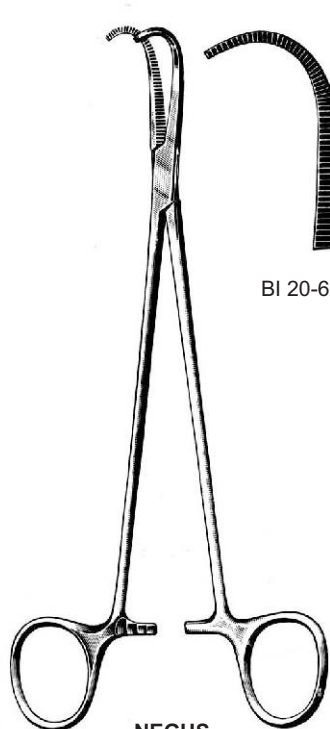

NEGUS
19.0cm

BI 20-6195-01 BI 20-6195-02

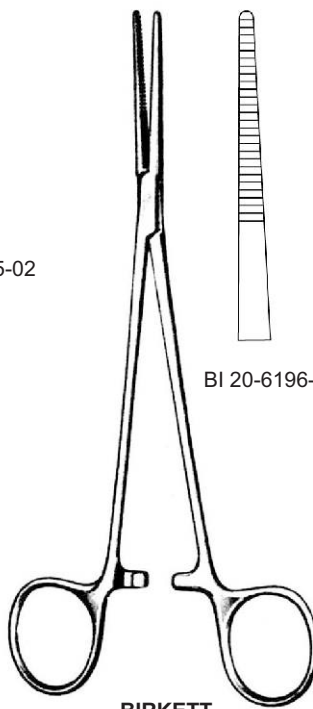

BIRKETT
19.0cm

BI 20-6196-01 BI 20-6196-02 BI 20-6196-03

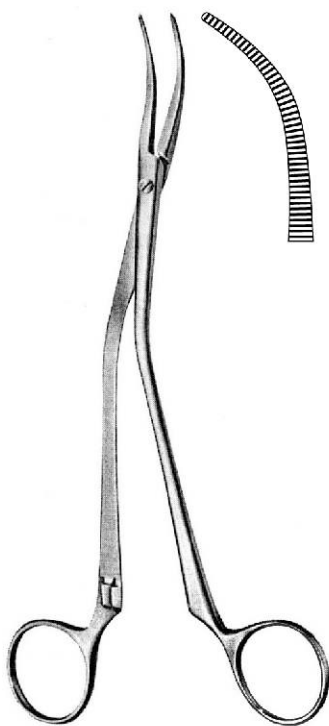

WILSON
BI 20-6197-19
19.0cm

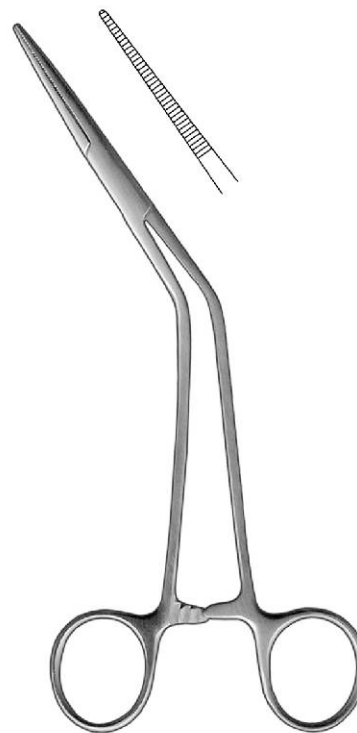

MOLLISON
BI 20-6198-01 18.0cm (with horizontal opening)
BI 20-6198-02 18.0cm (with vertical opening)





Eves
BI 20-6199-28
28 cm/11"



Eves
BI 20-6200-28
28 cm/11"

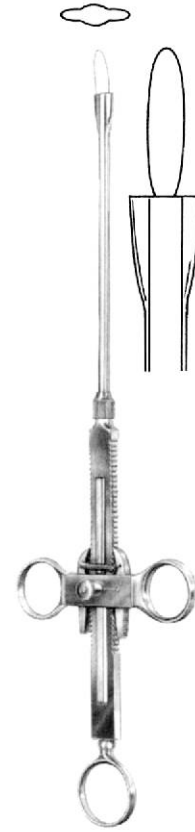

Bruenings
BI 20-6201-28
28 cm/11"

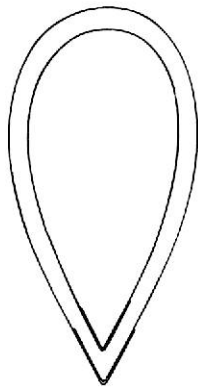

BI 20-6202-40 40mm BI 20-6203-03 0.3mm Ø
 BI 20-6202-50 50mm

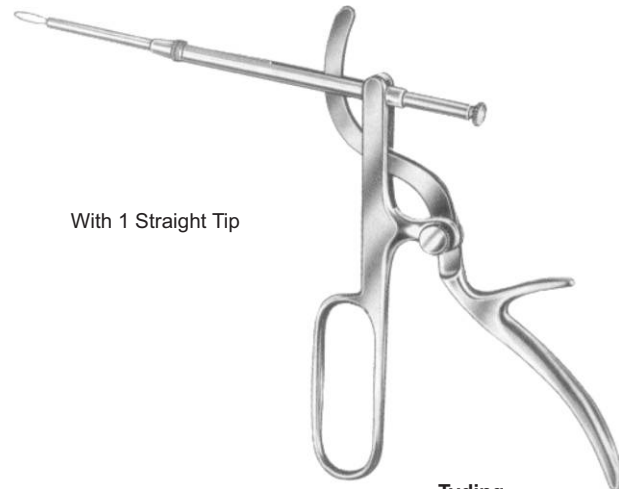

With 1 Straight Tip

Tyding
BI 20-6204-00

Tonsil

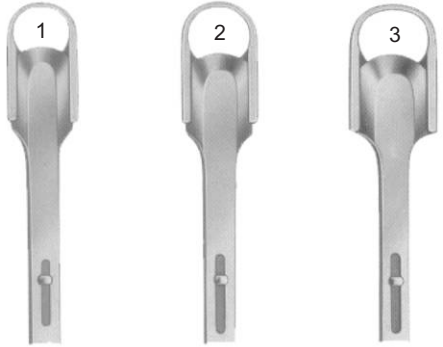

BI 20-6205-01 BI 20-6205-02 BI 20-6205-03



Sluder-Ballenger
 Complete, With 3 Tips
 BI 20-6205-00



Corwin
 BI 20-6206-14
 14 cm/5 "

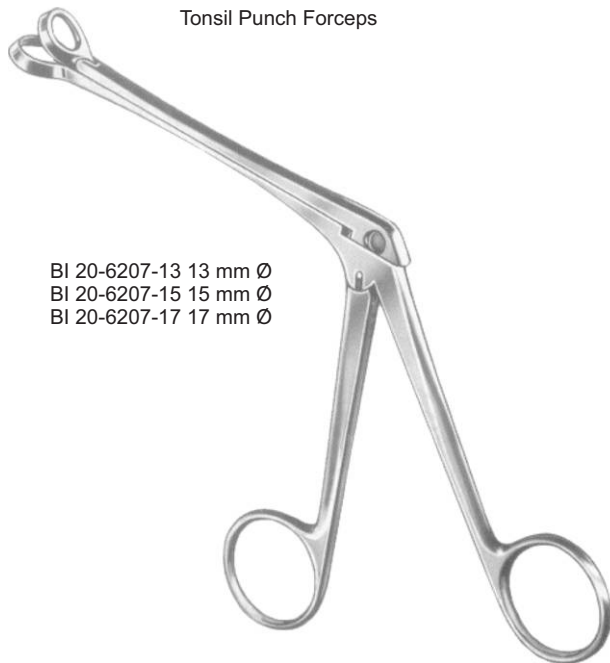

Tonsil Punch Forceps

BI 20-6207-13 13 mm Ø
 BI 20-6207-15 15 mm Ø
 BI 20-6207-17 17 mm Ø

Hartmann

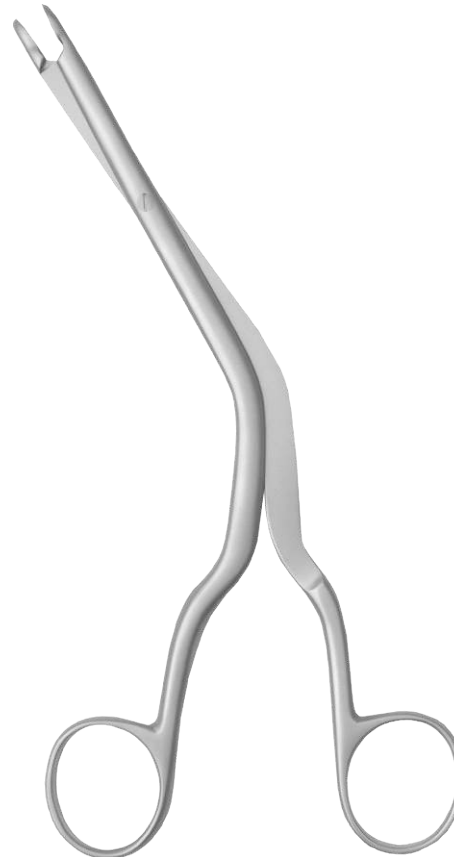

Luc Forceps
 BI 20-6208-01 Blall
 BI 20-6208-02 Medium
 BI 20-6208-03 Large
 20cm/8"





Waugh Dissecting Forcep
BI 20-6209-20
1 x 2 teeth
20cm/8"



Waugh Dissecting Forcep
BI 20-6210-20
serrated
20cm/8"

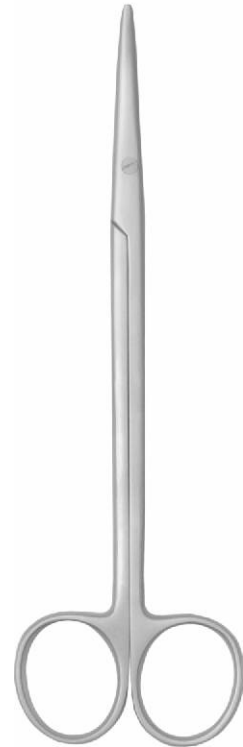

Metzenbaum Scissor Cvd.
BI 20-6211-18
18cm/7"

Tonsil

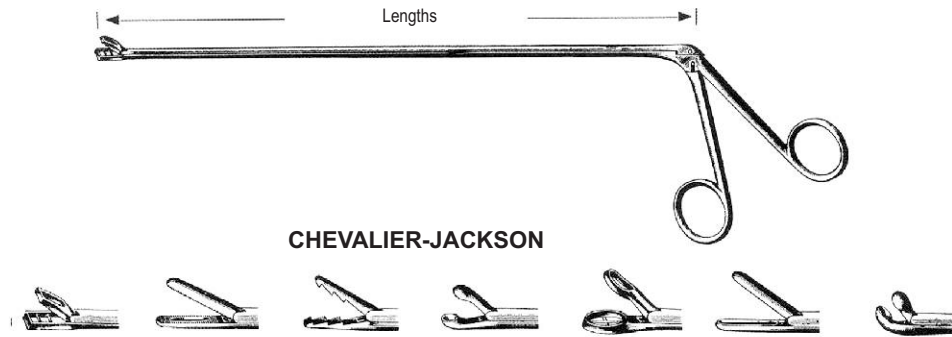

CHEVALIER-JACKSON

30.0cm	BI 20-6212-30	BI 20-6213-30	BI 20-6214-30	BI 20-6215-30	BI 20-6216-30	BI 20-6217-30	BI 20-6218-30
40.0cm	BI 20-6212-40	BI 20-6213-40	BI 20-6214-40	BI 20-6215-40	BI 20-6216-40	BI 20-6217-40	BI 20-6218-40
50.0cm	BI 20-6212-50	BI 20-6213-50	BI 20-6214-50	BI 20-6215-50	BI 20-6216-50	BI 20-6217-50	BI 20-6218-50
60.0cm	BI 20-6212-60	BI 20-6213-60	BI 20-6214-60	BI 20-6215-60	BI 20-6216-60	BI 20-6217-60	BI 20-6218-60

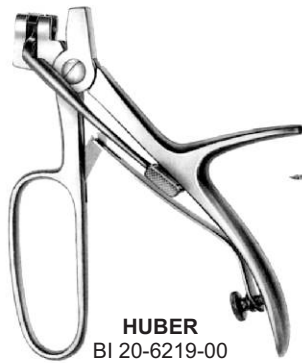

HUBER
 BI 20-6219-00



BRUENINGS (straight)
 BI 20-6219-20 20.0cm
 BI 20-6219-30 30.0cm
 BI 20-6219-40 40.0cm
 BI 20-6219-50 50.0cm
 BI 20-6219-60 60.0cm



BRUENINGS
 BI 20-6220-00

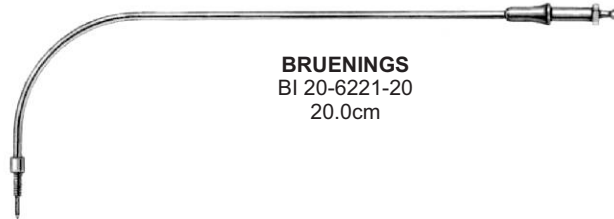

BRUENINGS
 BI 20-6221-20
 20.0cm





FRAENKEL
BI 20-6222-00



BARACANI
BI 20-6223-00



SEIFFERT
BI 20-6224-00



FRAENKEL
BI 20-6225-00

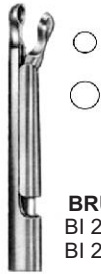

BRUENINGS
BI 20-6226-01
BI 20-6226-02



BRUENINGS
BI 20-6227-01
BI 20-6227-02



LANGE
BI 20-6228-00



KRAUSE
BI 20-6229-01
BI 20-6229-02



SCHUMACHER
BI 20-6230-00

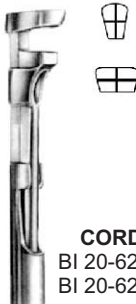

CORDES
BI 20-6231-01
BI 20-6231-02



CORDES
BI 20-6232-00



ROSENBERG
BI 20-6233-00



KRAUSE
BI 20-6234-00

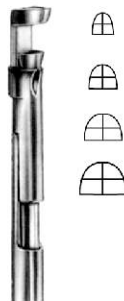

CORDES
BI 20-6235-01
BI 20-6235-02
BI 20-6235-03
BI 20-6235-04



SCHEINMANN
BI 20-6236-00



SCHEINMANN
BI 20-6237-00

Tonsil



BI 20-6238-11

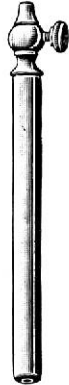

BI 20-6239-10

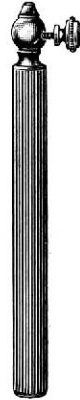

BI 20-6240-11



BI 20-6241-12



BI 20-6242-00



MICHEL
 25.0cm



BI 20-6243-12



BI 20-6243-14



BI 20-6243-16



BI 20-6243-18



BI 20-6244-08
 BI 20-6244-10
 BI 20-6244-12
 BI 20-6244-14
 BI 20-6244-16
 BI 20-6244-18
 BI 20-6244-20
 BI 20-6244-22
 BI 20-6244-24
 BI 20-6244-26
 BI 20-6244-28
 BI 20-6244-30

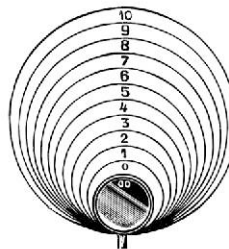

fig.00, 8mm Ø
 fig.0, 10mm Ø
 fig.1, 12mm Ø
 fig.2, 14mm Ø
 fig.3, 16mm Ø
 fig.4, 18mm Ø
 fig.5, 20mm Ø
 fig.6, 22mm Ø
 fig.7, 24mm Ø
 fig.8, 26mm Ø
 fig.9, 28mm Ø
 fig.10, 30mm Ø



BI 20-6245-08
 BI 20-6245-10
 BI 20-6245-12
 BI 20-6245-14
 BI 20-6245-16
 BI 20-6245-18
 BI 20-6245-20
 BI 20-6245-22
 BI 20-6245-24
 BI 20-6245-26
 BI 20-6245-28
 BI 20-6245-30





BI 20-6246-01



BI 20-6246-02



BI 20-6246-03

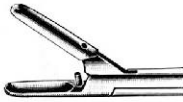

BI 20-6246-04

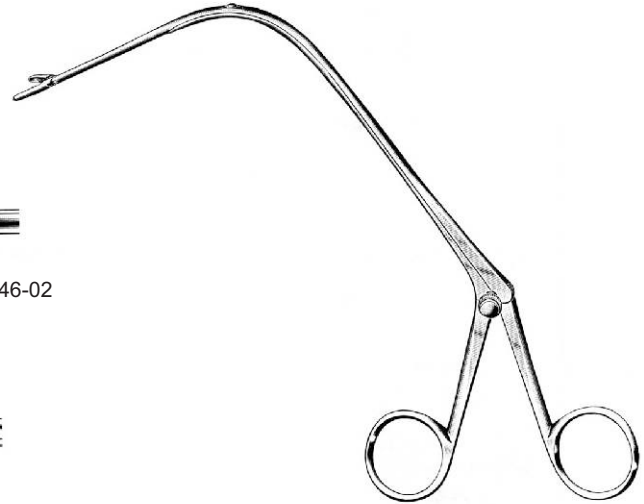

JURASZ
23.0cm

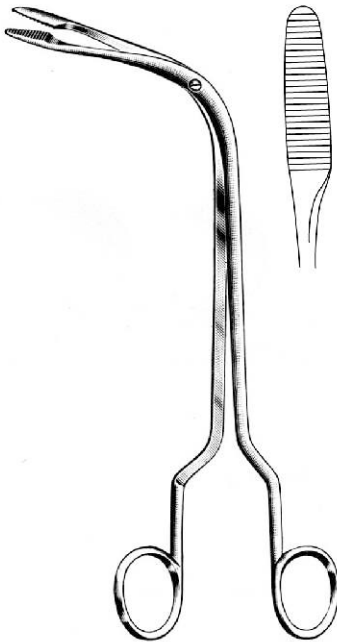

FRAENKEL
BI 20-6247-19
19.0cm

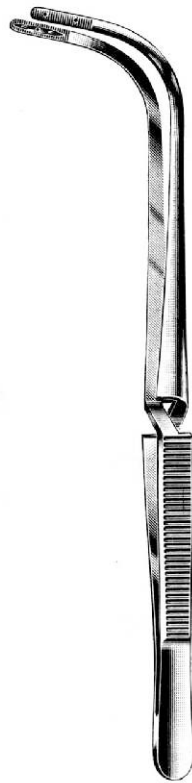

JACKSON
22.0cm



BI 20-6248-22



BI 20-6248-22



REICHERT
BI 20-6249-24
24.0cm