

18

- EN** Neurosurgery
- DE** Neurochirurgie
- ES** Neuro Cirugía
- FR** Neurochirurgie
- IT** Neurochirurgia

Page 373 to 387

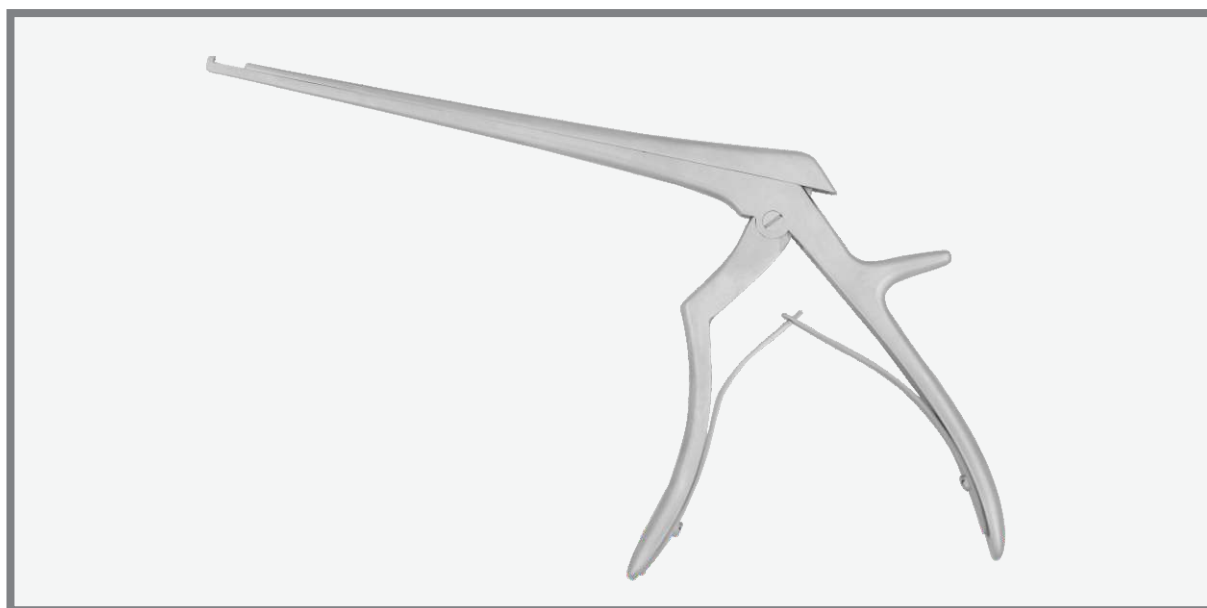



FRAZIER
BI 18-5301-15
15 cm/5 7/8"



HOEN
BI 18-5302-15
15 cm/5 7/8"



HOEN
BI 18-5303-15
15 cm/5 7/8"



SACHS
BI 18-5304-21
21 cm/8 1/4"

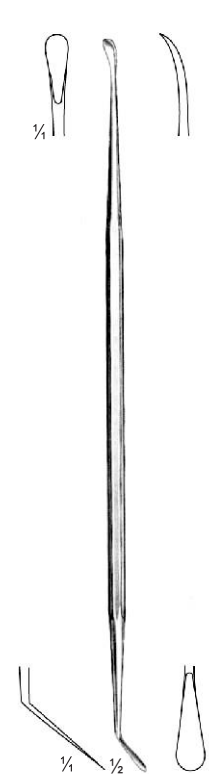

MILLIGAN
BI 18-5305-21
21 cm/8 1/4"

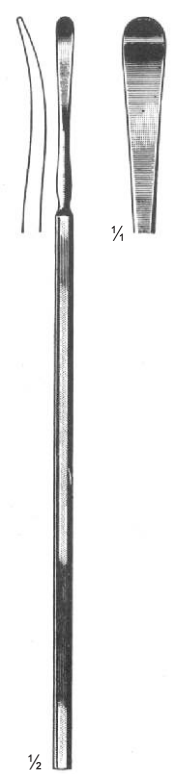

SACHS
BI 18-5306-21
21 cm/8 1/4"

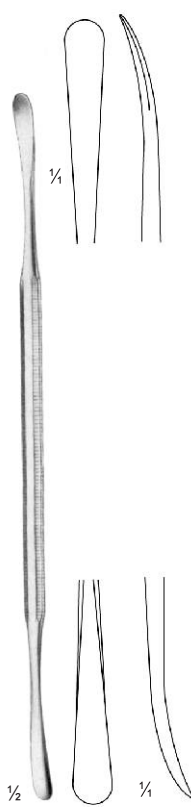

BI 18-5307-22
22 cm/8 3/4"

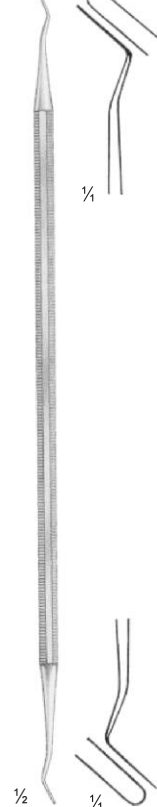

WOODSON
BI 18-5308-25
25 cm/9 7/8"

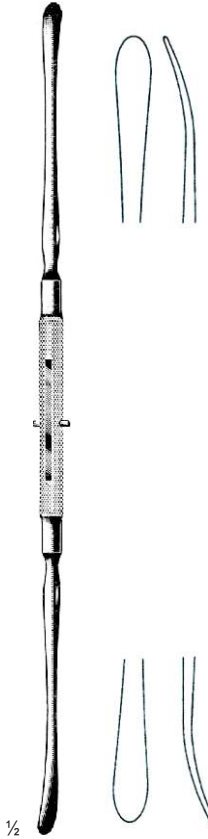

DAVIS
BI 18-5309-24
24.5 cm/9 5/8"



BI 18-5310-21
21 cm/8 1/4"



FAGER
BI 18-5311-20
20 cm/7 7/8"



FAGER
BI 18-5312-20
20 cm/7 7/8"

Neurosurgery

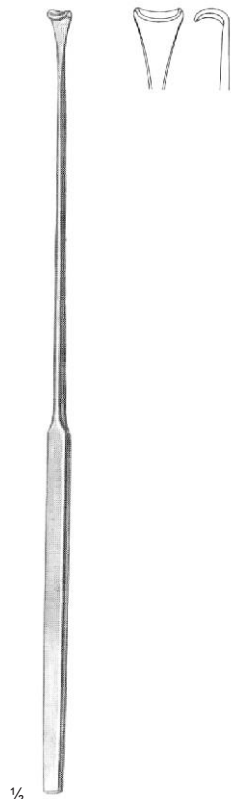

LOVE
 BI 18-5313-21
 21.5 cm/8 1/2"

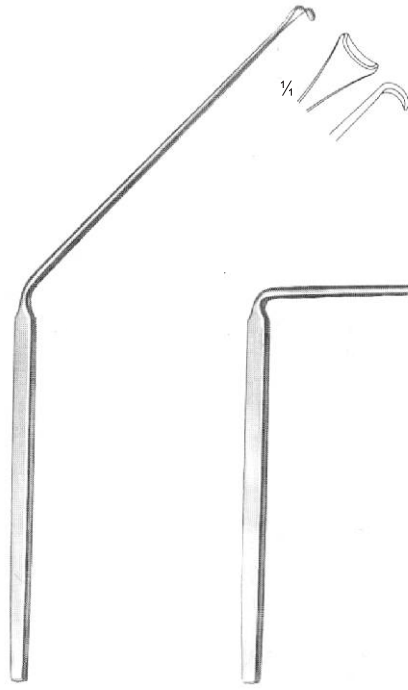

LOVE
 BI 18-5314-17
 17.5 cm/6 7/8"

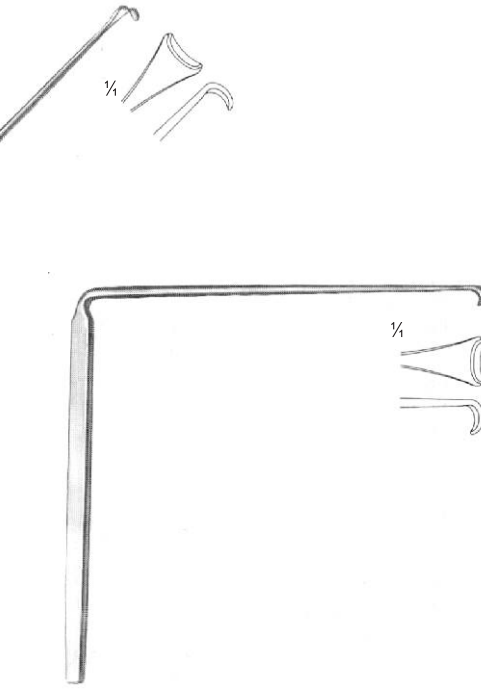

LOVE
 BI 18-5315-11
 11 cm/4 3/8"

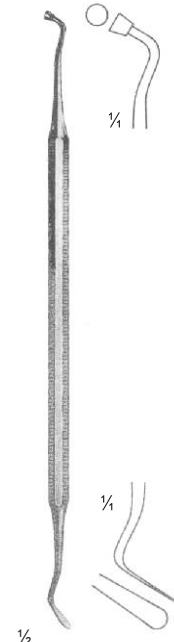

WOODSON
 BI 18-5316-17
 17 cm/6 3/4"

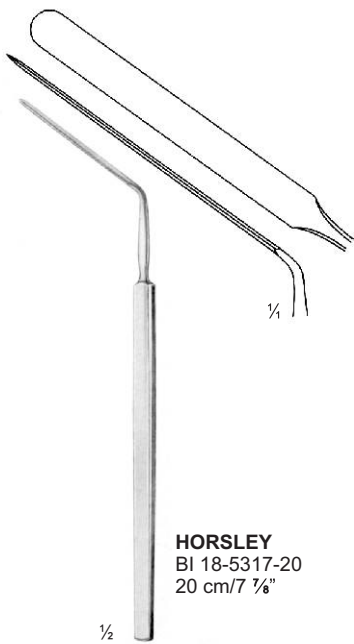

HORSLEY
 BI 18-5317-20
 20 cm/7 7/8"

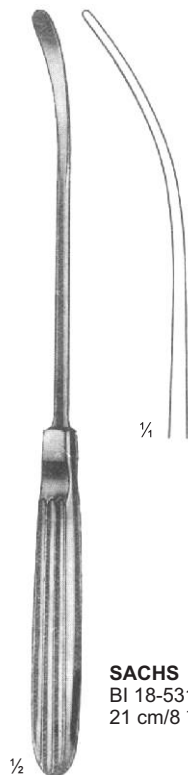

SACHS
 BI 18-5318-21
 21 cm/8 1/4"

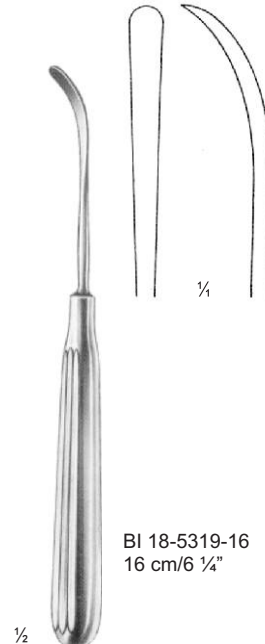

BI 18-5319-16
 16 cm/6 1/4"

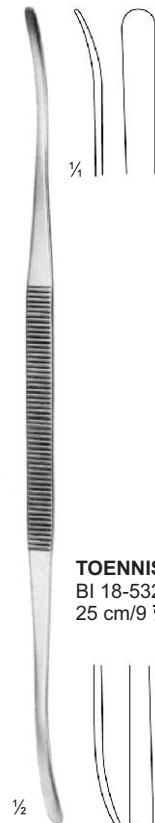

TOENNIS
 BI 18-5320-20
 25 cm/9 7/8"



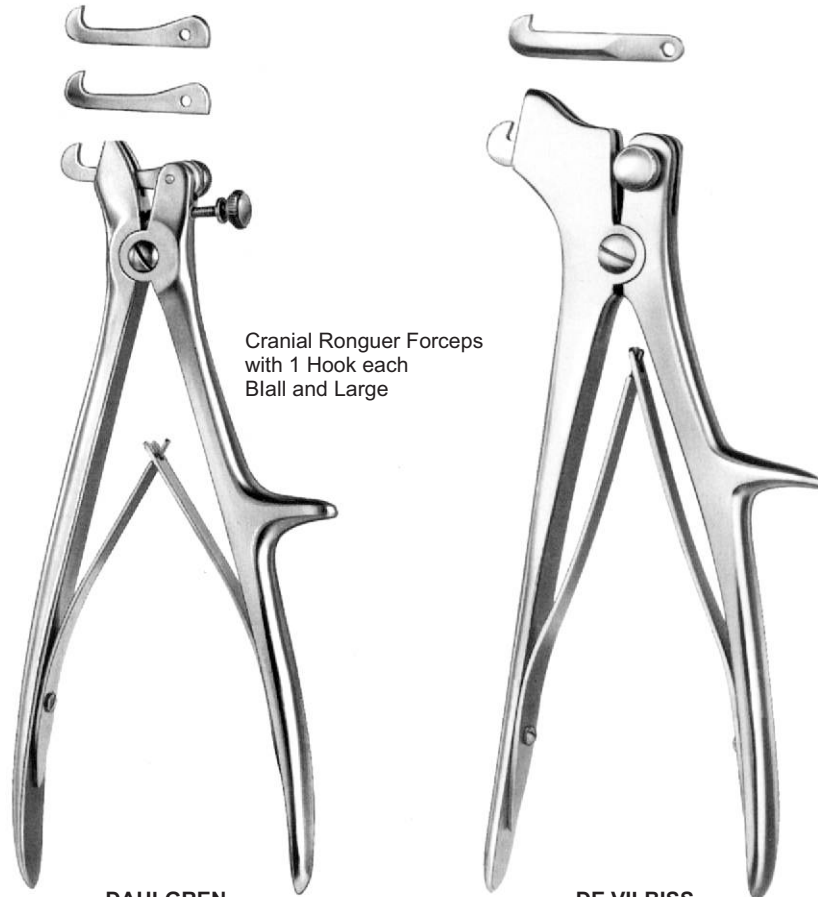

Cranial Ronguer Forceps
with 1 Hook each
Blall and Large

DAHLGREN
BI 18-5321-20
20 cm/7 7/8"

DE VILBISS
BI 18-5322-21
21 cm/8 1/4"



McKENZIE
BI 18-5323-15 15cm/5 7/8"
BI 18-5323-19 19cm/7 1/2"

McKENZIE
BI 18-5324-15 15cm/5 7/8"
BI 18-5324-19 19cm/7 1/2"

RANEY
BI 18-5325
Applying and removing
forceps for scalp hemostasis clip

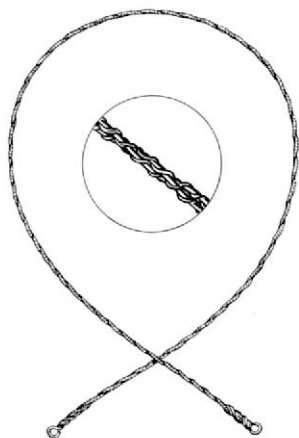

GIGLI-WIRE SAW
 2 wires twisted

- BI 18-5326-30 30cm
- BI 18-5326-40 40cm
- BI 18-5326-50 50cm
- BI 18-5326-60 60cm
- BI 18-5326-70 70cm

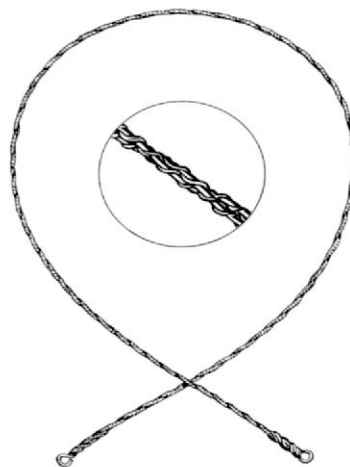

GIGLI-WIRE SAW
 6 wires twisted

- BI 18-5327-30 30cm
- BI 18-5327-40 40cm
- BI 18-5327-50 50cm



GIGLI
 BI 18-5328-07
 7 cm/2 3/4"
 Hook handle
 for wire saw



De MARTEL
 BI 18-5329-33
 33 cm/13"
 Conductor for
 wire saws



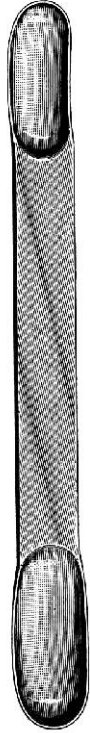

CUSHING
 BI 18-5330-17 17cm/6 3/4"
 BI 18-5330-20 20cm/7 7/8"
 BI 18-5330-28 28cm/11"

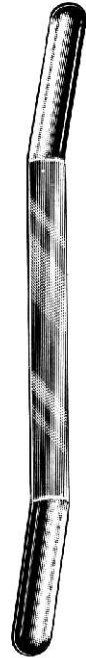

Concave
 BI 18-5331-18
 BI 18-5332-18
 BI 18-5333-18
 BI 18-5334-18



OLIVECRONA
 18 cm/7 1/8"
 width of spatulas



Convex
 BI 18-5335-18
 BI 18-5336-18
 BI 18-5337-18
 BI 18-5338-18



lower end



1/2

SCOVILLE
 BI 18-5339-23
 23 cm/9"

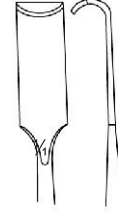

1/2

HOLSHER
 BI 18-5340-24
 24 cm/9 1/2"

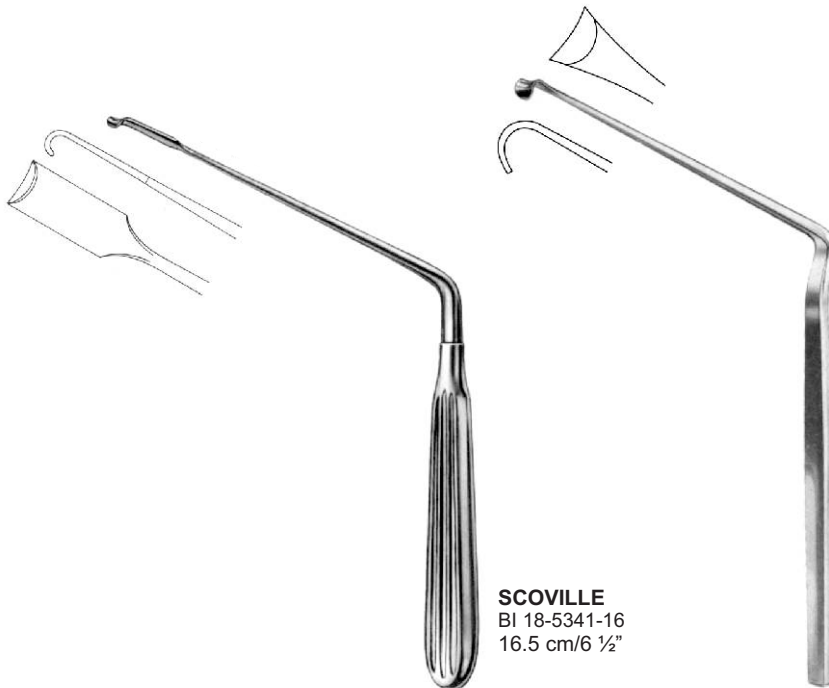
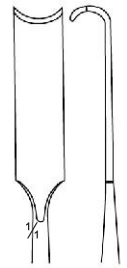

SCOVILLE
 BI 18-5341-16
 16.5 cm/6 1/2"

BI 18-5342-21
 21 cm/8 1/4"

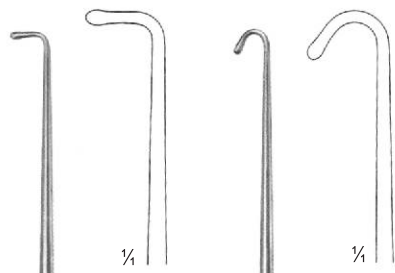

GRONINGEN
 BI 18-5343-26
 26.5 cm/10 3/8"

GRONINGEN
 BI 18-5344-26
 26.5 cm/10 3/8"

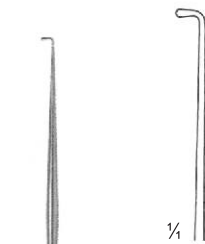

CUSHING

Fig. 1
 BI 18-5345-19
 19 cm/7 1/2"

Fig. 1
 BI 18-5345-28
 28 cm/11"

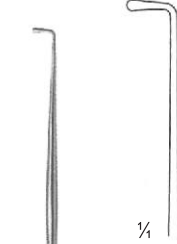

CUSHING

Fig. 2
 BI 18-5346-19
 19 cm/7 1/2"

Fig. 2
 BI 18-5346-28
 28 cm/11"

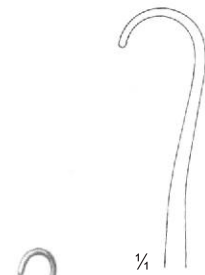

BIITHWICK

DF-237-2787
 17 cm/6 3/4"

BI 18-5347-21
 21 cm/8 1/4"





GRAHAM
BI 18-5348-16
16.5 cm/6 1/2"



SACHS
BI 18-5349-17
17 cm/6 3/4"



FRAZIER

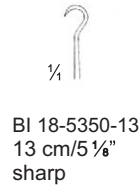

BI 18-5350-13
13 cm/5 1/8"
sharp

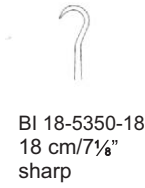

BI 18-5350-18
18 cm/7 1/8"
sharp



ADSON
BI 18-5351-20
20 cm/7 7/8"



KRAYENBÜHL
 19 cm/7 1/2"



Fig. 1
 BI 18-5352-19



Fig. 2
 BI 18-5353-19



Fig. 1
 BI 18-5354-19

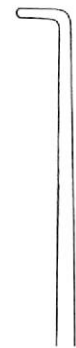
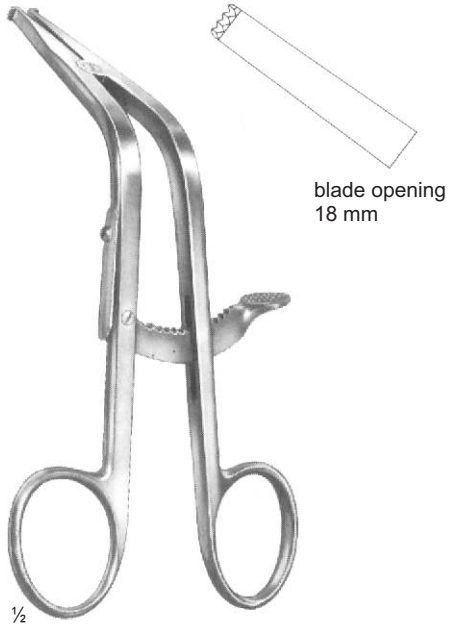
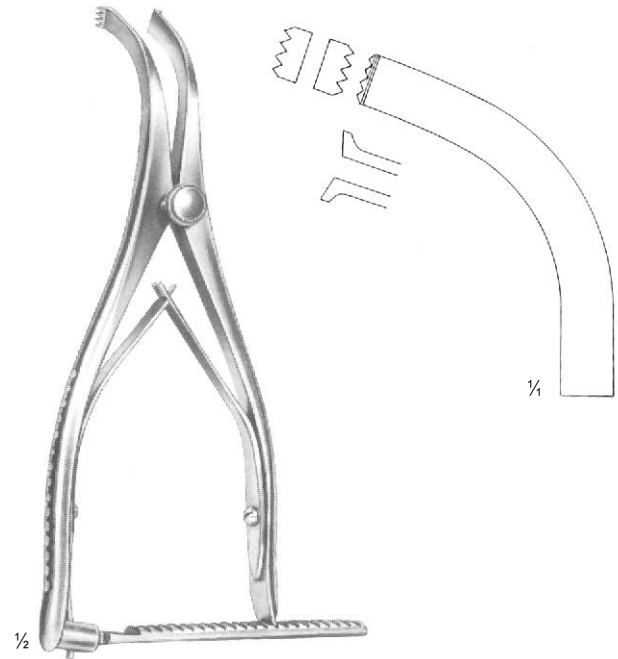

Fig. 2
 BI 18-5355-19





CLOWARD
 BI 18-5356-16
 16 cm/6 1/4"



INGE
 BI 18-5357-16
 16.5 cm/6 1/2"
 Blade opening 35 mm

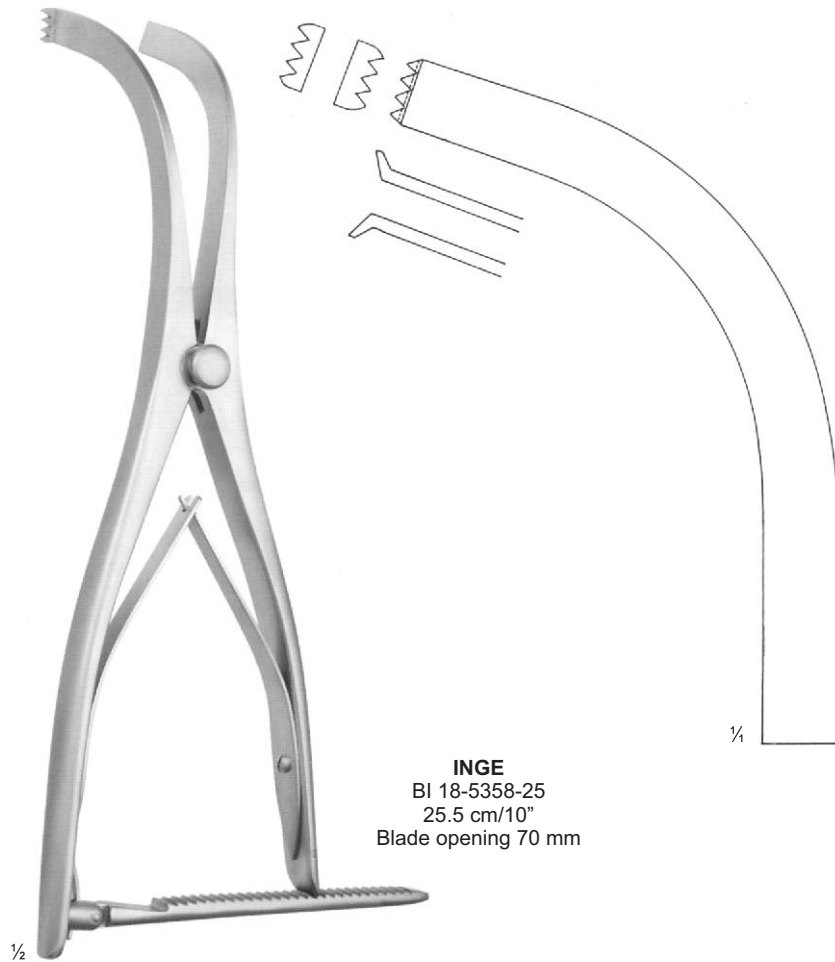

INGE
 BI 18-5358-25
 25.5 cm/10"
 Blade opening 70 mm

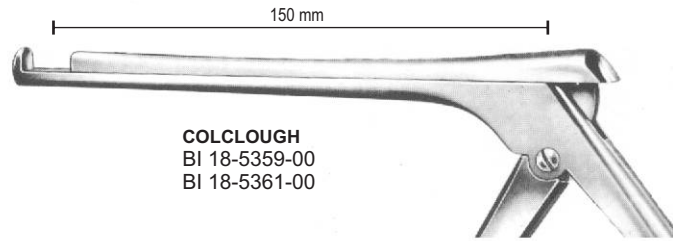

COLCLOUGH
 BI 18-5359-00
 BI 18-5361-00

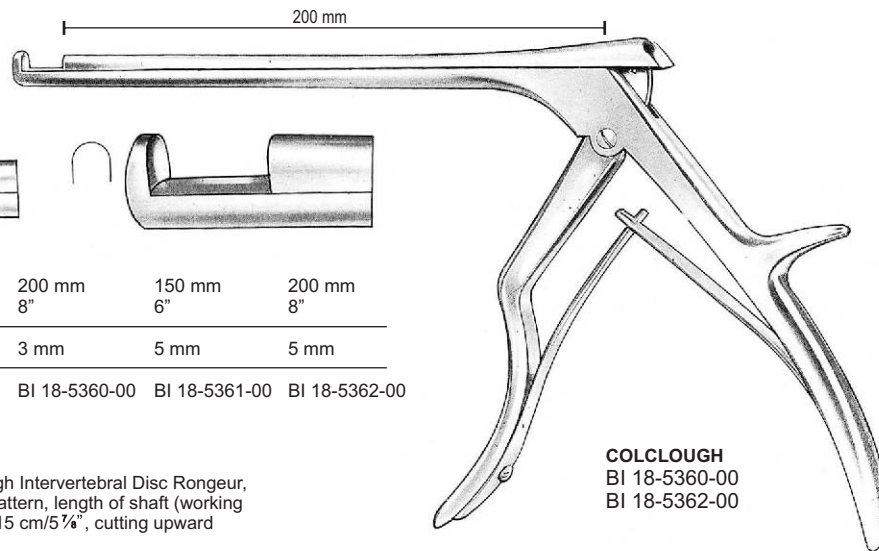

COLCLOUGH
 BI 18-5360-00
 BI 18-5362-00

Length of shaft	150 mm 6"	200 mm 8"	150 mm 6"	200 mm 8"
Width of bite	3 mm	3 mm	5 mm	5 mm
Cat. Ref.	BI 18-5359-00	BI 18-5360-00	BI 18-5361-00	BI 18-5362-00

- BI 18-5359-00 - BI 18-5361-00 Colclough Intervertebral Disc Rongeur, heavy pattern, length of shaft (working length) 15 cm/5 7/8", cutting upward desired.
- BI 18-5360-00 - BI 18-5362-00 ditto, length of shaft (working length) 20 cm/7 7/8"
- BI 18-5362-00 - BI 18-5363-00 ditto, length of shaft (working length) 15 cm/5 7/8", cutting downward
- BI 18-5362-00 - BI 18-5362-00 ditto, length of shaft (working length) 20 cm/7 7/8"

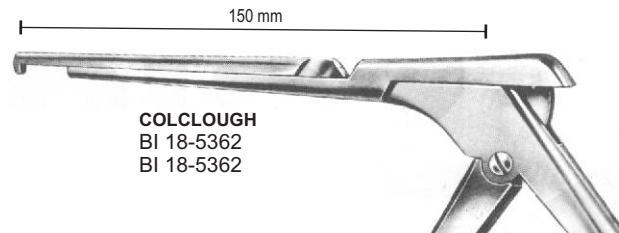

COLCLOUGH
 BI 18-5362
 BI 18-5362

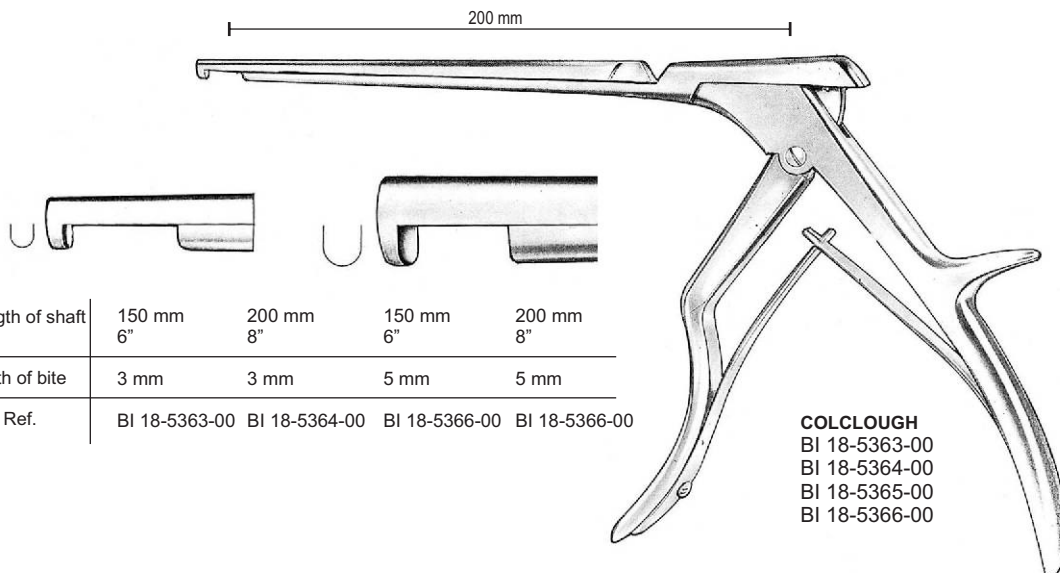

Length of shaft	150 mm 6"	200 mm 8"	150 mm 6"	200 mm 8"
Width of bite	3 mm	3 mm	5 mm	5 mm
Cat. Ref.	BI 18-5363-00	BI 18-5364-00	BI 18-5366-00	BI 18-5366-00

COLCLOUGH
 BI 18-5363-00
 BI 18-5364-00
 BI 18-5365-00
 BI 18-5366-00



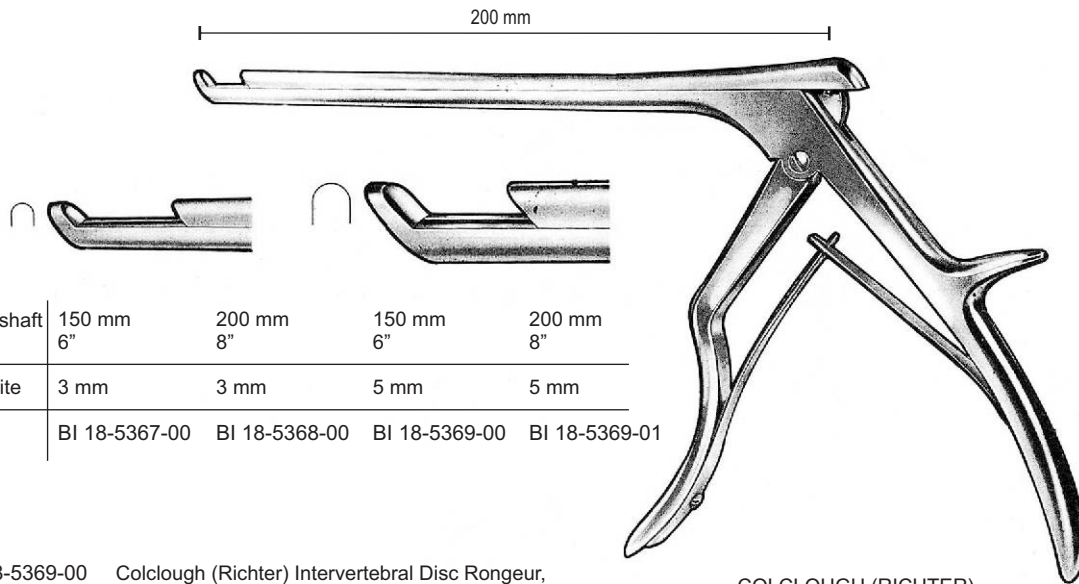
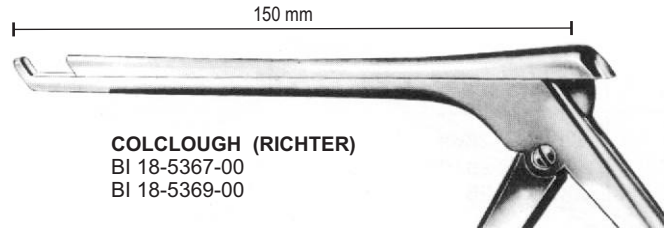

Length of shaft	150 mm 6"	200 mm 8"	150 mm 6"	200 mm 8"
Width of bite	3 mm	3 mm	5 mm	5 mm
Cat. Ref.	BI 18-5367-00	BI 18-5368-00	BI 18-5369-00	BI 18-5369-01

BI 18-5367-00 - BI 18-5369-00 Colclough (Richter) Intervertebral Disc Rongeur, heavy pattern, length of shaft (working length) 15 cm/6", cutting 40° forward

COLCLOUGH (RICHTER)
 BI 18-5368-00
 BI 18-5369-01

BI 18-5368-00 - BI 18-5369-01 ditto, length of shaft (working length) 20 cm/7 7/8"

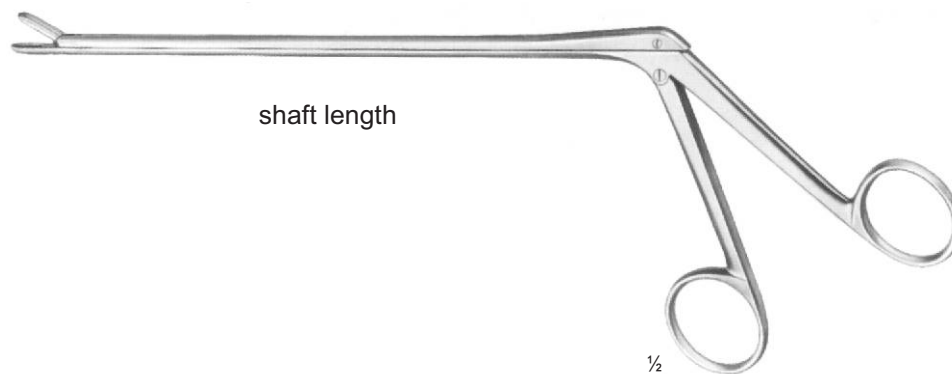

CUSHING
 straight

BI 18-5370-12 120 mm
 BI 18-5370-15 150 mm
 BI 18-5370-18 180 mm

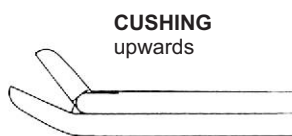

CUSHING
 upwards

BI 18-5371-12 120 mm
 BI 18-5371-15 150 mm
 BI 18-5371-18 180 mm

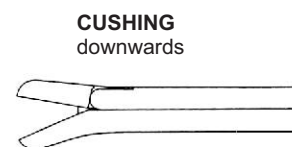

CUSHING
 downwards

BI 18-5372-12 120 mm
 BI 18-5372-15 150 mm
 BI 18-5372-18 180 mm

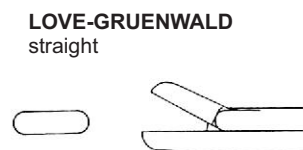

LOVE-GRUENWALD
 straight

BI 18-5373-12 120 mm
 BI 18-5373-15 150 mm
 BI 18-5373-18 180 mm

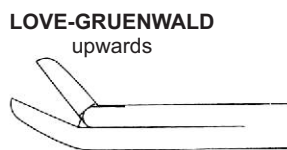

LOVE-GRUENWALD
 upwards

BI 18-5374-12 120 mm
 BI 18-5374-15 150 mm
 BI 18-5374-18 180 mm

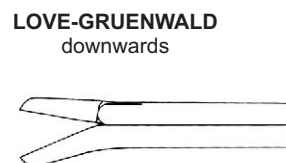

LOVE-GRUENWALD
 downwards

BI 18-5375-12 120 mm
 BI 18-5375-15 150 mm
 BI 18-5375-18 180 mm

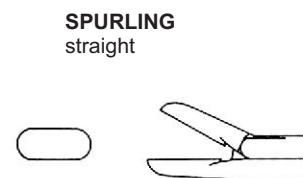

SPURLING
 straight

BI 18-5376-12 120 mm
 BI 18-5376-15 150 mm
 BI 18-5376-18 180 mm

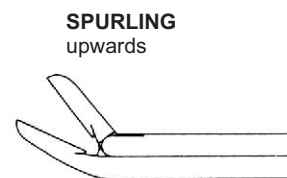

SPURLING
 upwards

BI 18-5377-12 120 mm
 BI 18-5377-15 150 mm
 BI 18-5377-18 180 mm

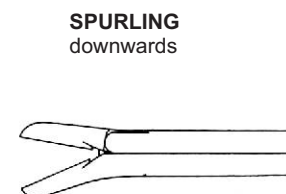

SPURLING
 downwards

BI 18-5378-12 120 mm
 BI 18-5378-15 150 mm
 BI 18-5378-18 180 mm



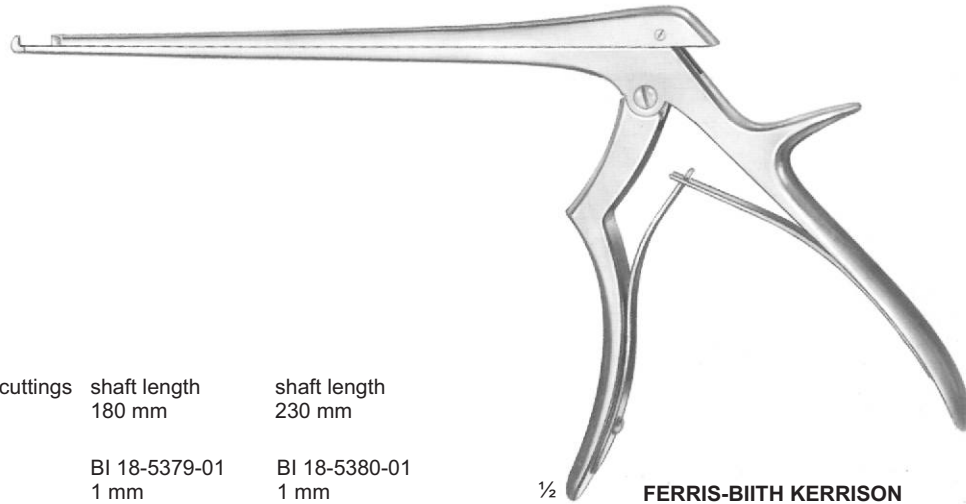

upwards cuttings	shaft length 180 mm	shaft length 230 mm
	BI 18-5379-01 1 mm	BI 18-5380-01 1 mm
	BI 18-5379-02 2 mm	BI 18-5380-02 2 mm
	BI 18-5379-03 3 mm	BI 18-5380-03 3 mm
	BI 18-5379-04 4 mm	BI 18-5380-04 4 mm
	BI 18-5379-05 5 mm	BI 18-5380-05 5 mm
	BI 18-5379-06 6 mm	BI 18-5380-06 6 mm

downwards cuttings	shaft length 180 mm
	BI 18-5383-03 3 mm

downwards cuttings	shaft length 180 mm	shaft length 230 mm
	BI 18-5381-01 1 mm	BI 18-5382-01 1 mm
	BI 18-5381-02 2 mm	BI 18-5382-02 2 mm
	BI 18-5383-03 3 mm	BI 18-5382-03 3 mm
	BI 18-5383-04 4 mm	BI 18-5382-04 4 mm
	BI 18-5383-05 5 mm	BI 18-5382-05 5 mm
	BI 18-5383-06 6 mm	BI 18-5382-06 6 mm

upwards cuttings	shaft length 180 mm	shaft length 230 mm
	BI 18-5384-01 1 mm	BI 18-5385-01 1 mm
	BI 18-5384-02 2 mm	BI 18-5385-02 2 mm
	BI 18-5384-03 3 mm	BI 18-5385-03 3 mm
	BI 18-5384-04 4 mm	BI 18-5385-04 4 mm
	BI 18-5384-05 5 mm	BI 18-5385-05 5 mm
	BI 18-5384-06 6 mm	BI 18-5385-06 6 mm



FERRIS-BIITH KERRISON

upwards cuttings	shaft length 180 mm	shaft length 230 mm	upwards cuttings	shaft length 180 mm	shaft length 230 mm
	BI 18-5386-1 1 mm	BI 18-5387-1 1 mm		BI 18-5388-1 1 mm	BI 18-5389-1 1 mm
	BI 18-5386-2 2 mm	BI 18-5387-2 2 mm		BI 18-5388-2 2 mm	BI 18-5389-2 2 mm
	BI 18-5386-3 3 mm	BI 18-5387-3 3 mm		BI 18-5388-3 3 mm	BI 18-5389-3 3 mm
	BI 18-5386-4 4 mm	BI 18-5387-4 4 mm		BI 18-5388-4 4 mm	BI 18-5389-4 4 mm
	BI 18-5386-5 5 mm	BI 18-5387-5 5 mm		BI 18-5388-5 5 mm	BI 18-5389-5 5 mm
	BI 18-5386-6 6 mm	BI 18-5387-6 6 mm		BI 18-5388-6 6 mm	BI 18-5389-6 6 mm



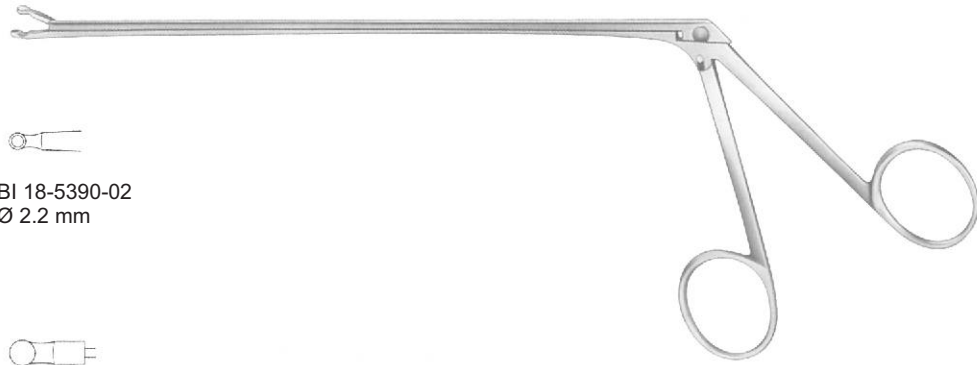

BI 18-5390-02
Ø 2.2 mm



BI 18-5390-03
Ø 3.5 mm

YASARGIL

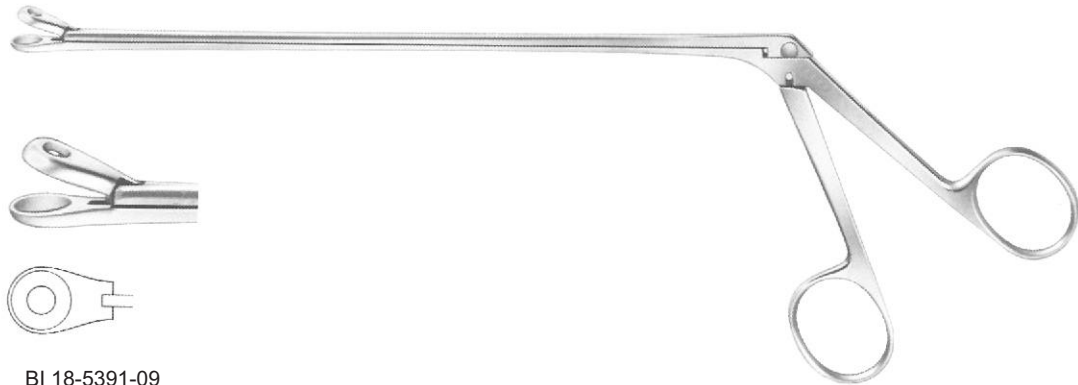

BI 18-5391-09
Ø 9.0 mm

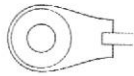
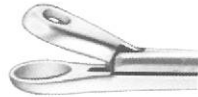

LANDOLT
Tumor grasping forceps, blunt

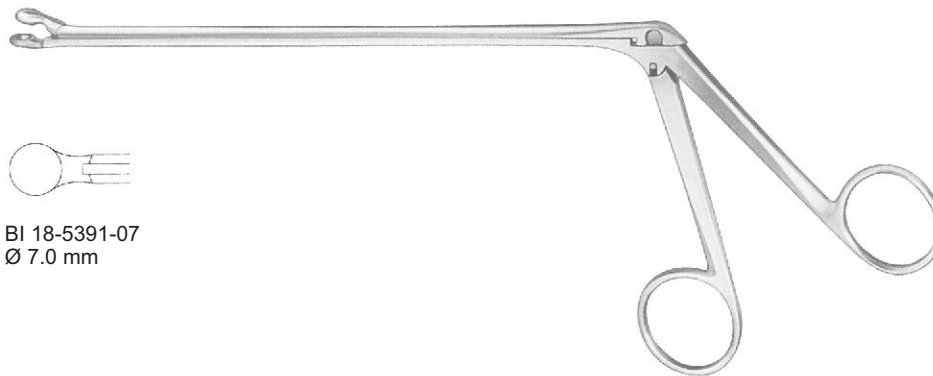

BI 18-5391-07
Ø 7.0 mm

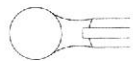

OLDBERG