

14

- EN** Bone Surgery
- DE** Knochenchirurgie
- ES** Cirugía ósea
- FR** Chirurgie osseuse
- IT** Chirurgia ossea

Page 170 to 268

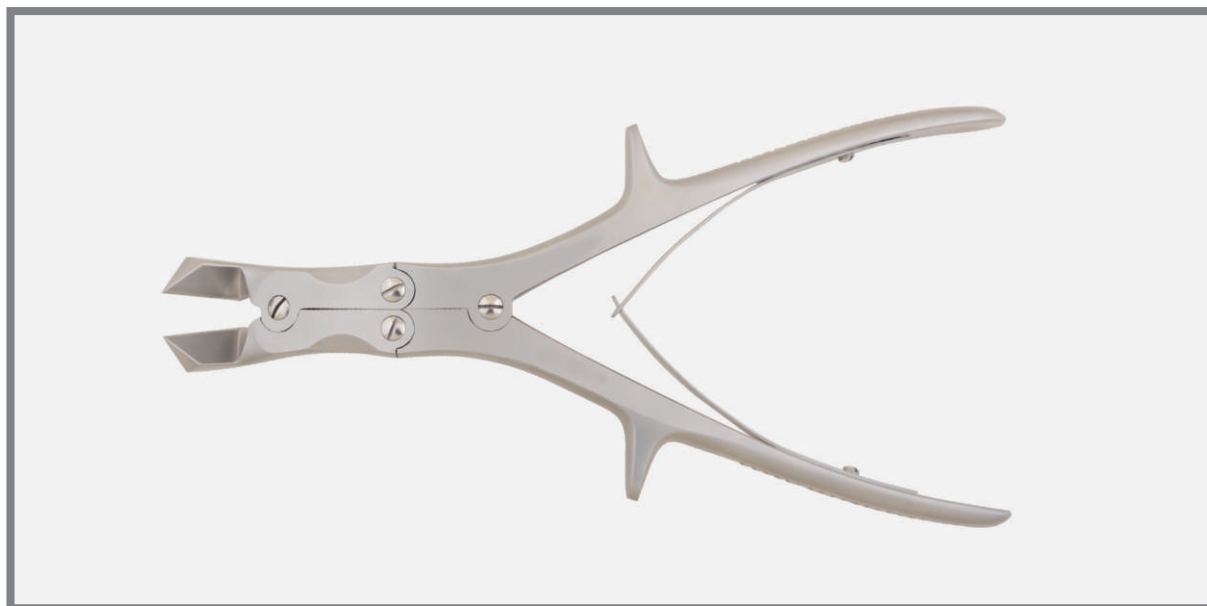



Mead
BI 14-3001-17 17 cm/6 1/2"
26mm Ø, 320 g (11 1/4 oz)



Partsch
BI 14-3002-18 18 cm/7"
22mm Ø, 200 g (7 oz)

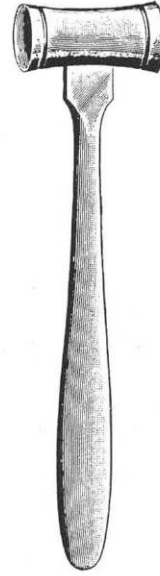

BI 14-3003-30
30mm Ø, 510 g

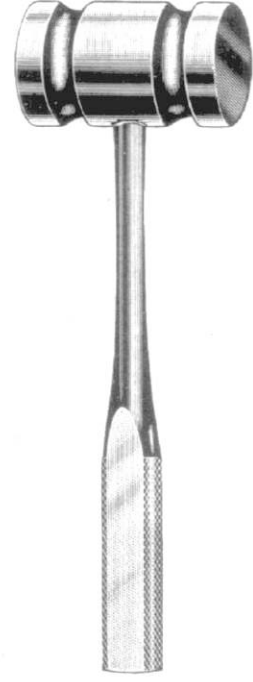

BI 14-3004-26 250 g
BI 14-3005-26 450 g
26.5 cm/10 3/4"

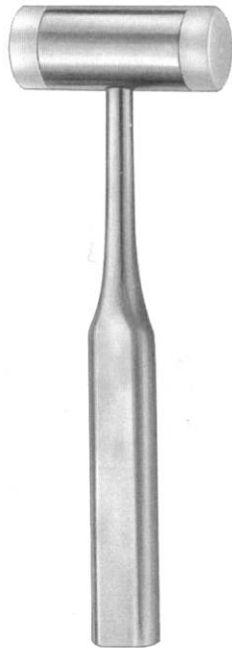

BI 14-3006-18 18.5 cm/7 1/2"
25mm Ø 135 g



lead filled

BI 14-3007-19 19 cm/7 3/4"
22mm Ø 155 g



Hajek
BI 14-3008-22 22 cm/8 3/4"
27mm Ø 130 g

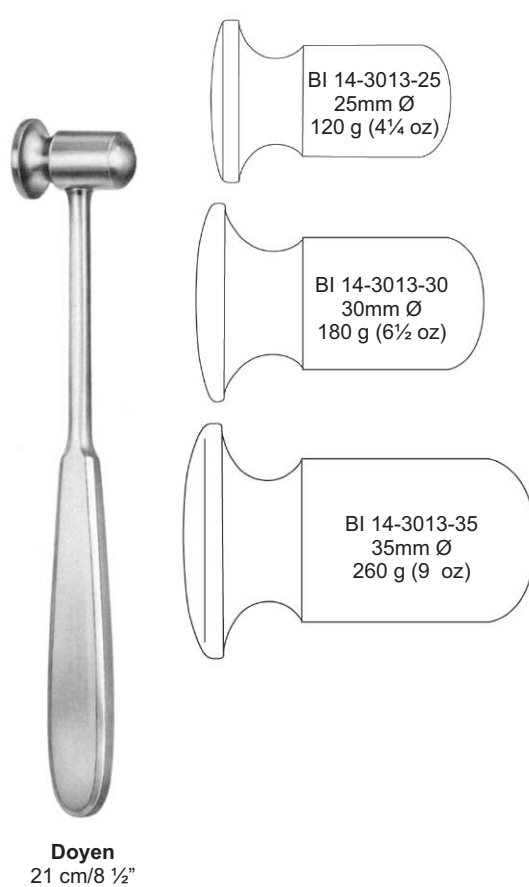
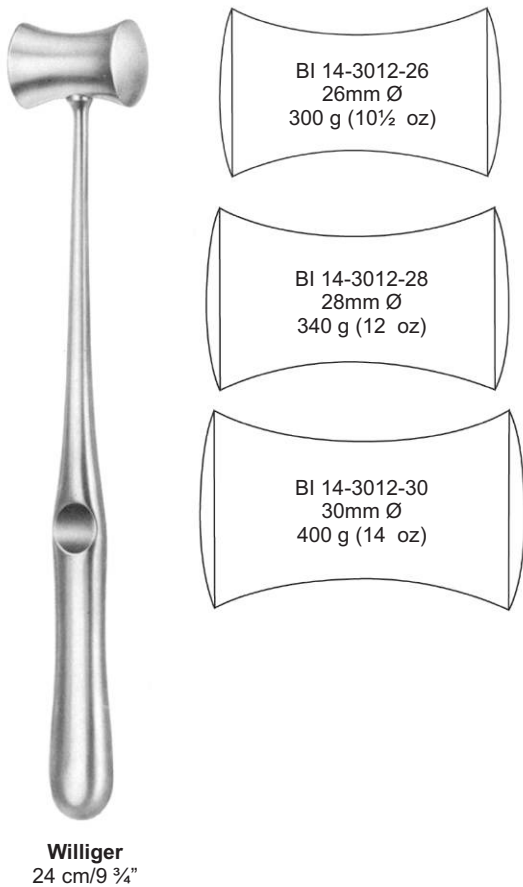
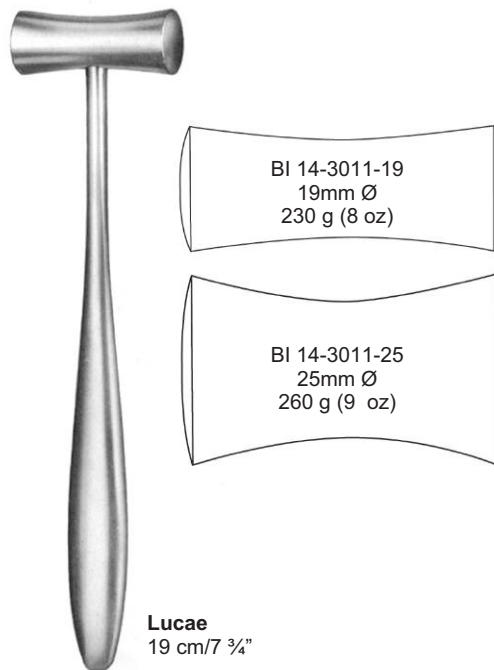
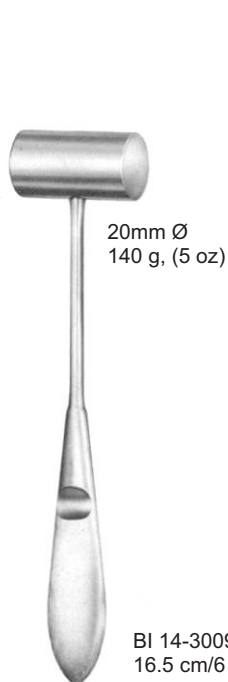

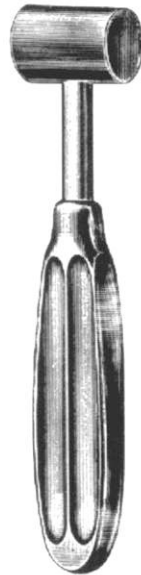

Gerzog
BI 14-3014-18
18 cm/7"
250 g

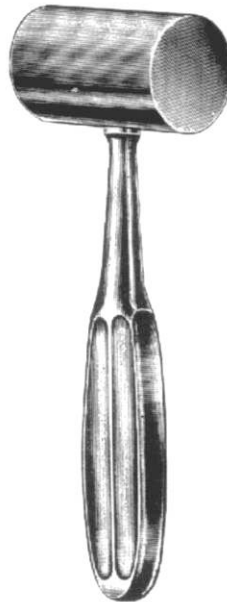

Kirk
BI 14-3015-19
19 cm/7 1/2"
750 g

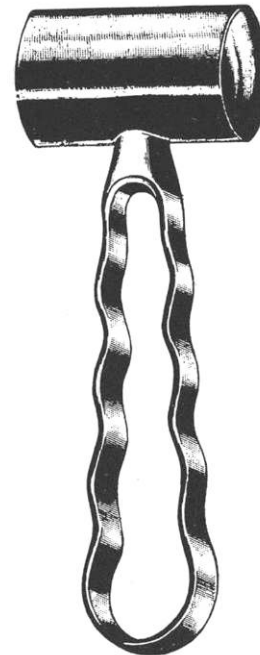

Heath
18 cm/7"
BI 14-3016-35 35mm Ø (28 oz)
BI 14-3016-40 40mm Ø (36 oz)



42mm Ø 30mm Ø
BI 14-3017-26
26.5 cm/10 1/2"
530 g (19 oz)



BI 14-3018-24
24 cm/9 1/2"
(30mm Ø 480 g)



BI 14-3019-22
22.5 cm/9"
(37mm Ø 370 g)

BI 14-3020-00
Spare Faces



BI 14-3020-24
24 cm/9 1/2"



BI 14-3021-26 26.5 cm/10 1/2"
 30mm Ø, 510 g (18 oz)



BI 14-3022-26
 26.5 cm/10 1/2"



BI 14-3023-25 250 g (0.55 lbs)
 BI 14-3023-45 450 g (1 lbs)
 BI 14-3023-90 900 g (2 lbs)
 26.5 cm/10 1/2"





Partsch
 mm 02 BI 14-3024-02
 03 BI 14-3024-03
 04 BI 14-3024-04
 05 BI 14-3024-05
 06 BI 14-3024-06
 07 BI 14-3024-07
 08 BI 14-3024-08
 13.5 cm/5 1/4"



Partsch
 BI 14-3025-02
 BI 14-3025-03
 BI 14-3025-04
 BI 14-3025-05
 BI 14-3025-06
 BI 14-3025-07
 BI 14-3025-08
 17 cm/6 3/4"

Partsch
 BI 14-3026-02
 BI 14-3026-03
 BI 14-3026-04
 BI 14-3026-05
 BI 14-3026-06
 BI 14-3026-07
 BI 14-3026-08
 13.5 cm/5 1/4"

BI 14-3027-02
 BI 14-3027-03
 BI 14-3027-04
 BI 14-3027-05
 BI 14-3027-06
 BI 14-3027-07
 BI 14-3027-08
 17cm/6 3/4"



Width

mm 04 BI 14-3028-04
 06 BI 14-3028-06
 08 BI 14-3028-08
 10 BI 14-3028-10
 12 BI 14-3028-12
 14 BI 14-3028-14
 16 BI 14-3028-16

BI 14-3029-04
 BI 14-3029-06
 BI 14-3029-08
 BI 14-3029-10
 BI 14-3029-12
 BI 14-3029-14
 BI 14-3029-16
 13.5 cm/5 1/4"

BI 14-3030-04
 BI 14-3030-06
 BI 14-3030-08
 BI 14-3030-10
 BI 14-3030-12
 BI 14-3030-14
 BI 14-3030-16

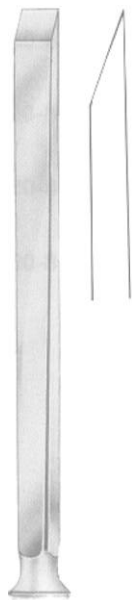

Mod. USA
 mm 06 BI 14-3031-06
 12 BI 14-3031-12
 18 BI 14-3031-18

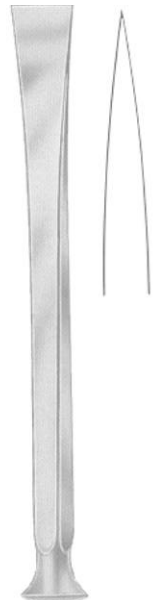

BI 14-3032-06
 BI 14-3032-12
 BI 14-3032-18
 16 cm/6 1/4"



BI 14-3033-06
 BI 14-3033-12
 BI 14-3033-18



16 cm/6 1/4"

BI 14-3034-03
 3mm
 BI 14-3034-05
 5mm
 BI 14-3034-07
 7mm
 2BI 14-3034-09
 9mm



Passow
 12 cm/4 3/4"

BI 14-3035-02
 2.5mm
 BI 14-3035-03
 3.5mm

BONE SURGERY



Lexer
 27.5 cm/10¾"

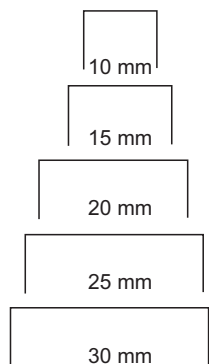

BI 14-3036-10
 BI 14-3036-15
 BI 14-3036-20
 BI 14-3036-25
 BI 14-3036-30



BI 14-3037-10
 BI 14-3037-15
 BI 14-3037-20
 BI 14-3037-25
 BI 14-3037-30



Cloward
 24 cm/9½"

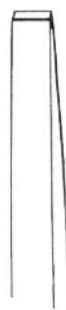
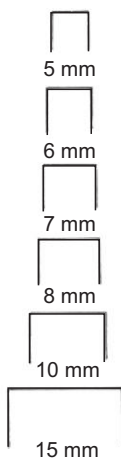

BI 14-3038-05
 BI 14-3038-06
 BI 14-3038-07
 BI 14-3038-08
 BI 14-3038-10
 BI 14-3038-15



BI 14-3039-05
 BI 14-3039-06
 BI 14-3039-07
 BI 14-3039-08
 BI 14-3039-10
 BI 14-3039-15





BI 14-3040-10

BUCK-GRAMCKO
11 cm/4 1/2"



BI 14-3041-10



BI 14-3042-10

BUCK-GRAMCKO
10 cm/4"



BI 14-3043-10



BUCKLEY
16 cm/6 1/2"



BI 14-3044-02
2mm



BI 14-3044-03
3mm



BI 14-3044-04
4mm

BONE SURGERY

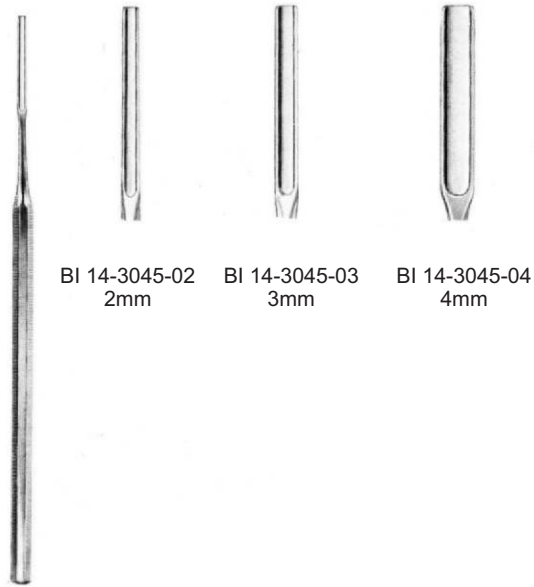

BI 14-3045-02
2mm

BI 14-3045-03
3mm

BI 14-3045-04
4mm

BUCKLEY
16 cm/6 1/2"





Alexander
18 cm/7"

	mm	
BI 14-3046-04	04	BI 14-3047-04
BI 14-3046-06	06	BI 14-3047-06
BI 14-3046-08	08	BI 14-3047-08
BI 14-3046-10	10	BI 14-3047-10
BI 14-3046-12	12	BI 14-3047-12
BI 14-3046-14	14	BI 14-3047-14

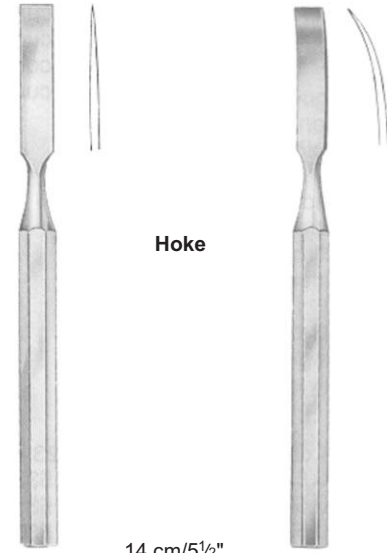

Hoke

14 cm/5½"

	mm	
BI 14-3048-02	2	BI 14-3049-02
BI 14-3048-03	3	BI 14-3049-03
BI 14-3048-04	4	BI 14-3049-04
BI 14-3048-05	5	BI 14-3049-05
BI 14-3048-06	6	BI 14-3049-06
BI 14-3048-07	7	BI 14-3049-07
BI 14-3048-08	8	BI 14-3049-08



Blith-Petersen
20 cm/8"



mm				
06	BI 14-3050-06	BI 14-3051-06	BI 14-3052-06	BI 14-3053-06
09	BI 14-3050-09	BI 14-3051-09	BI 14-3052-09	BI 14-3053-09
13	BI 14-3050-13	BI 14-3051-13		
14			BI 14-3052-14	BI 14-3053-14
16	BI 14-3050-16	BI 14-3051-16	BI 14-3052-16	BI 14-3053-16
19	BI 14-3050-19	BI 14-3051-19	BI 14-3052-19	BI 14-3053-19
25	BI 14-3050-25	BI 14-3051-25	BI 14-3052-25	BI 14-3053-25
32	BI 14-3050-32	BI 14-3051-32	BI 14-3052-32	BI 14-3053-32

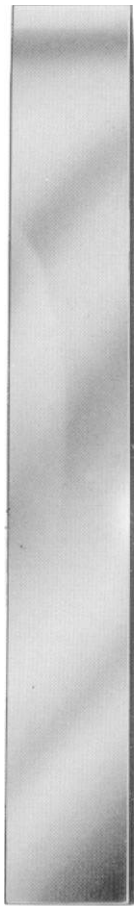

Lambotte
 mm
 BI 14-3054-04 04
 BI 14-3054-06 06
 BI 14-3054-08 08
 BI 14-3054-10 10
 BI 14-3054-13 13
 BI 14-3054-16 16
 BI 14-3054-18 18
 BI 14-3054-20 20
 BI 14-3054-25 25
 BI 14-3054-30 30
 BI 14-3054-38 38
 BI 14-3054-44 44
 BI 14-3054-50 50
 24 cm/9½"

Curved

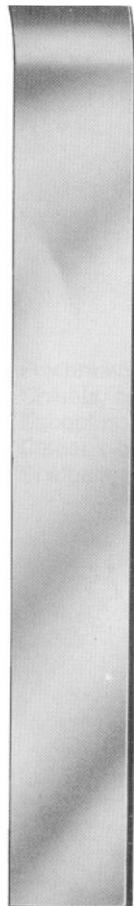

BI 14-3055-04
 BI 14-3055-06
 BI 14-3055-08
 BI 14-3055-10
 BI 14-3055-13
 BI 14-3055-16
 BI 14-3055-18
 BI 14-3055-20
 BI 14-3055-25
 BI 14-3055-30
 BI 14-3055-38
 BI 14-3055-44
 BI 14-3055-50
 23 cm/9"



Mini-Lambotte
 mm
 BI 14-3056-02 02
 BI 14-3056-03 03
 BI 14-3056-04 04
 BI 14-3056-06 06
 BI 14-3056-08 08
 BI 14-3056-10 10
 BI 14-3056-12 12
 BI 14-3056-15 15
 12.5 cm/5"
 BI 14-3057-02
 BI 14-3057-03
 BI 14-3057-04
 BI 14-3057-06
 BI 14-3057-08
 BI 14-3057-10
 BI 14-3057-12
 BI 14-3057-15
 17 cm/6¾"



Mini-Lexer
 mm
 3I 14-3058-04 04
 3I 14-3058-06 06
 3I 14-3058-08 08
 3I 14-3058-10 10
 3I 14-3058-12 12
 BI 14-3059-04
 BI 14-3059-06
 BI 14-3059-08
 BI 14-3059-10
 BI 14-3059-12
 18 cm/7"



Str **Lexer** **Cvd**
 mm
 BI 14-3060-05 05
 BI 14-3060-07 07
 BI 14-3060-10 10
 BI 14-3060-15 15
 BI 14-3060-20 20
 BI 14-3060-25 25
 BI 14-3060-30 30
 BI 14-3061-05
 BI 14-3061-07
 BI 14-3061-10
 BI 14-3061-15
 BI 14-3061-20
 BI 14-3061-25
 BI 14-3061-30
 22 cm/8¾"





Chisel
 BI 14-3062-20
 24.5 cm/9¾"
 20 mm



Chisel-Curved
 BI 14-3063-20
 26.5 cm/10½"
 20 mm

Gouge for the
 removing of
 broken screws



BI 14-3064-22
 22 cm/8¾"



Zielke
 23 cm/9"
 5.5 mm
 9.0 mm

BI 14-3065-05
 BI 14-3065-09



Width

mm

Stille
 20 cm/8"

06	BI 14-3066-06	BI 14-3067-06	BI 14-3068-06	BI 14-3069-06	BI 14-3070-06
08	BI 14-3066-08	BI 14-3067-08	BI 14-3068-08	BI 14-3069-08	BI 14-3070-08
10	BI 14-3066-10	BI 14-3067-10	BI 14-3068-10	BI 14-3069-10	BI 14-3070-10
12	BI 14-3066-12	BI 14-3067-12	BI 14-3068-12	BI 14-3069-12	BI 14-3070-12
15	BI 14-3066-15	BI 14-3067-15	BI 14-3068-15	BI 14-3069-15	BI 14-3070-15
20	BI 14-3066-20	BI 14-3067-20	BI 14-3068-20	BI 14-3069-20	BI 14-3070-20
25	BI 14-3066-25	BI 14-3067-25	BI 14-3068-25	BI 14-3069-25	BI 14-3070-25
30	BI 14-3066-30	BI 14-3067-30	BI 14-3068-30	BI 14-3069-30	BI 14-3070-30



mm

Hibbs
 24 cm/9 1/2"

06	BI 14-3071-06	BI 14-3072-06	BI 14-3073-06	BI 14-3074-06	BI 14-3075-06
09	BI 14-3071-09	BI 14-3072-09	BI 14-3073-09	BI 14-3074-09	BI 14-3075-09
13	BI 14-3071-13	BI 14-3072-13	BI 14-3073-13	BI 14-3074-13	BI 14-3075-13
16	BI 14-3071-16	BI 14-3072-16	BI 14-3073-16	BI 14-3074-16	BI 14-3075-16
19	BI 14-3071-19	BI 14-3072-19	BI 14-3073-19	BI 14-3074-19	BI 14-3075-19
25	BI 14-3071-25	BI 14-3072-25	BI 14-3073-25	BI 14-3074-25	BI 14-3075-25
32	BI 14-3071-32	BI 14-3072-32	BI 14-3073-32	BI 14-3074-32	BI 14-3075-32





Lexer
 BI 14-3076-05
 BI 14-3076-10
 BI 14-3076-15
 28 cm/11"



Lexer
 BI 14-3077-05
 BI 14-3077-10
 BI 14-3077-15
 25 cm/10"



Lexer
 BI 14-3078-05
 BI 14-3078-10
 BI 14-3078-15
 25 cm/10"



BI 14-3079-01



BI 14-3079-02



BI 14-3079-03



Cobb
 28 cm/11" BI 14-3079-04

BONE SURGERY



Putti
 BI 14-3080-30
 30 cm/12"



Putti
 BI 14-3081-27
 27 cm/10½"



BI 14-3082-28
 28 cm/11"



BI 14-3083-24
 24 cm/9½"



BI 14-3084-22
 22 cm/8¾"

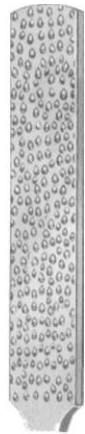

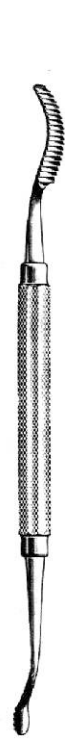

Miller
10
BI 14-3085-10



Miller
11
BI 14-3086-11



Miller
12
BI 14-3087-12



Miller
13
BI 14-3088-13



Miller
14
BI 14-3089-14



Miller
10c
BI 14-3090-10



Miller
11c
BI 14-3091-11



Miller
12c
BI 14-3092-12



Miller
13c
BI 14-3093-13



Fomon
21.5cm
BI 14-3094-21



Fomon
21.5cm
BI 14-3095-21

BONE SURGERY

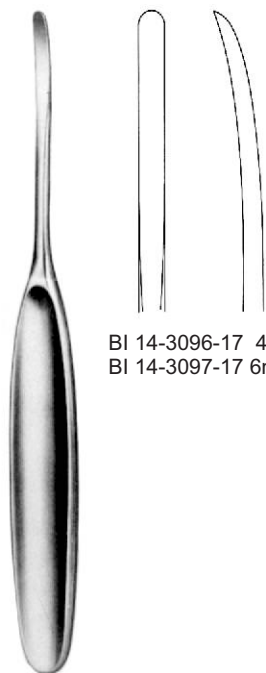

BI 14-3096-17 4mm
 BI 14-3097-17 6mm

CUSHING
 17 cm/8 1/2"



BI 14-3098-19 5mm
 BI 14-3099-19 7mm

CUSHING
 19.5 cm/7 3/4"



BI 14-3100-16 7mm, 16 cm/6 1/2"
 BI 14-3100-18 15mm, 18.5 cm/7 1/2"
 BI 14-3100-19 20mm, 19 cm/7 3/4"

HOEN

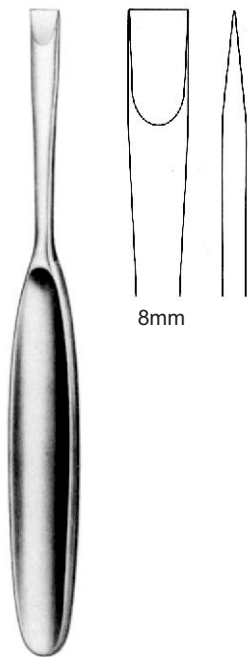

8mm

CUSHING
 BI 14-3101-17
 17 cm/6 3/4"



LANGENBECK
 BI 14-3102-18
 18 cm/7"

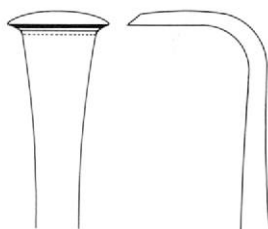

LANGENBECK
 BI 14-3103-19
 19 cm/7 3/4"

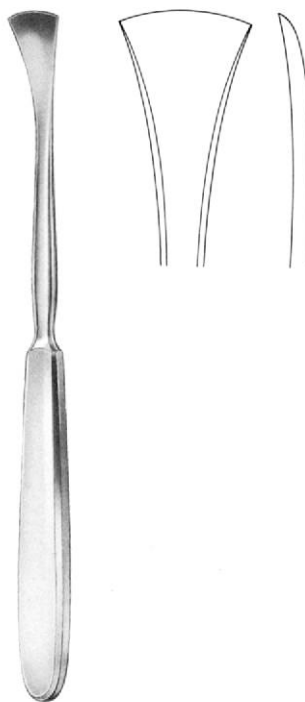

BI 14-3104-05
 5mm

BI 14-3104-06
 6mm

BI 14-3104-33
 7mm

16 cm/6 1/2"





Lambotte
21 cm/8¼"

Width

- BI 14-3105-21 05 mm
- BI 14-3106-21 10 mm
- BI 14-3107-21 15 mm
- BI 14-3108-21 20 mm
- BI 14-3109-21 25 mm

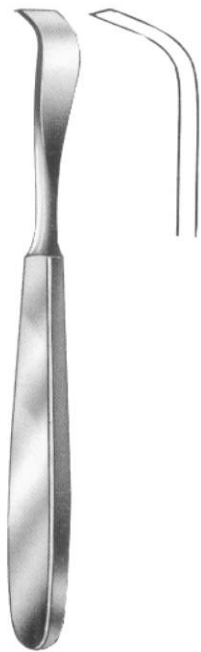

Schneider
BI 14-3110-17
13 mm
17.5 cm/7"



Schneider-Sauerbruch
BI 14-3111-19
13 mm
19 cm/7½"

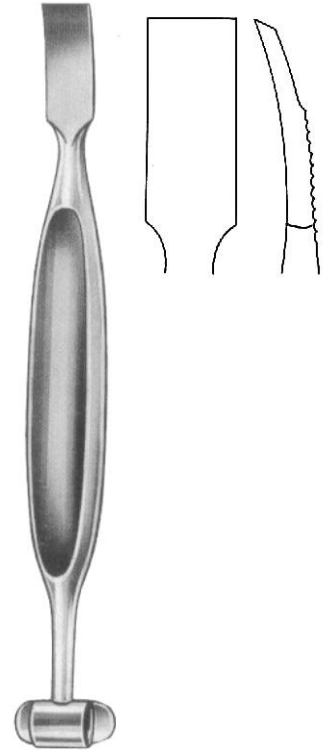

Alexander
BI 14-3112-20
20 cm/8"



Jansen
BI 14-3113-16
15 mm
16.5 cm/6½"



Seldin
BI 14-3114-19
19 cm/7½"



Davidson-Alexander
BI 14-3115-29
29 cm/11½"

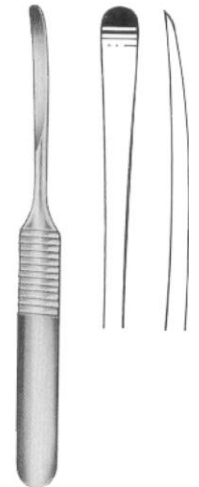

Williger
BI 14-3116-13
13 cm/5"

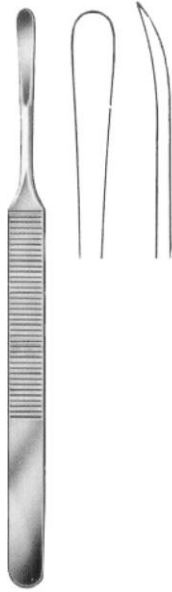

König
BI 14-3117-15
15.5 cm/6"
5 mm

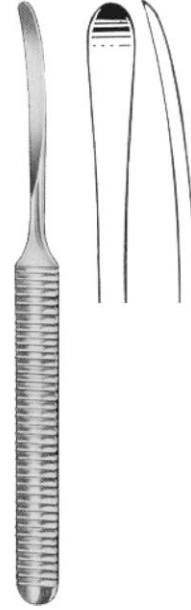

Williger
BI 14-3118-16
16 cm/6¼"



Adson
17 cm/6¾"



BI 14-3119-17



BI 14-3120-17



BI 14-3121-17



BI 14-3122-17



BI 14-3123-17 17 cm/6¾"
6 mm

BI 14-3124-17
8 mm



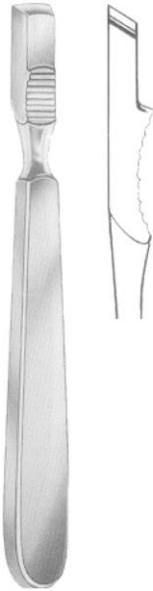

Farabeuf
BI 14-3125-15
15 cm/6"

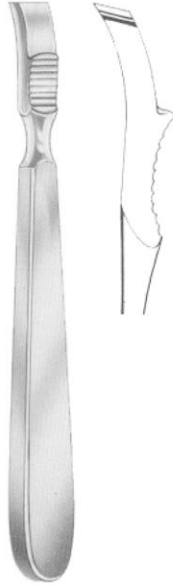

Farabeuf
BI 14-3126-15
15 cm/6"



Farabeuf-Collin
BI 14-3127-15
15.5 cm/6"
11 mm



Farabeuf-Collin
BI 14-3128-15
15.5 cm/6"
11 mm



Farabeuf
BI 14-3129-19
19 cm/7 1/2"
13 mm

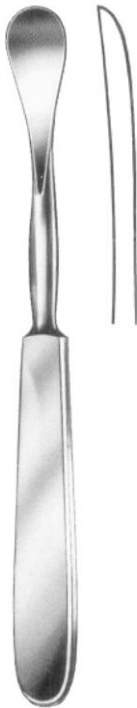

Sedillot
BI 14-3130-18
18 cm/7"
18 mm



Sedillot
BI 14-31301-21
21 cm/8 1/2"
15 mm



LANGENBECK

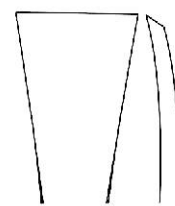

BI 14-3132-19
19.0cm, 16mm

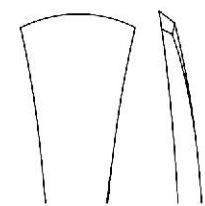

BI 14-3133-19
19.0cm, 16cm

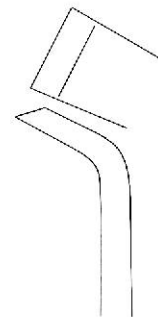

BI 14-3134-19
19.0cm, 12mm

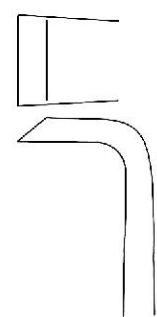

BI 14-3135-18
18.0cm, 12mm



Overholt
 BI 14-3136-29
 29.5 cm/11½"



Overholt
 BI 14-3137-29
 29.5 cm/11½"



Overholt
 BI 14-3138-28
 28.5 cm/11¼"



Hyllin
 BI 14-3141-14
 14.5 cm/5¾"



BI 14-3139-14



BI 14-3140-14



BI 14-3141-14



Matson
 BI 14-3142-22
 22 cm/8¾"





Semb

BI 14-3143-19
19.5 cm/7½"
12 mm



BI 14-3144-19
19.5 cm/7½"
12 mm



BI 14-3145-19
19.5 cm/7½"
12 mm



BI 14-3146-22
22 cm/8¾"
13 mm



BI 14-3147-21
21.5 cm/8½"
13 mm



BI 14-3148-22
22 cm/8½"
15 mm



BI 14-3149-22
22 cm/8½"
15 mm



Doyen
17 cm/6¾"

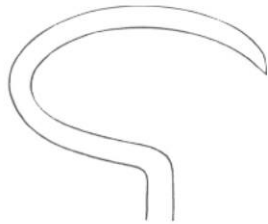

BI 14-3150-17

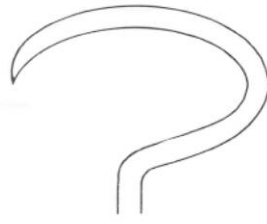

BI 14-3151-17



BI 14-3152-17



BI 14-3153-17



Doyen
BI 14-3154-24 24 cm/9½"



Doyen
BI 14-3155-24



BI 14-3156-24
4 mm



BI 14-3157-24
6 mm



BI 14-3158-24
8 mm

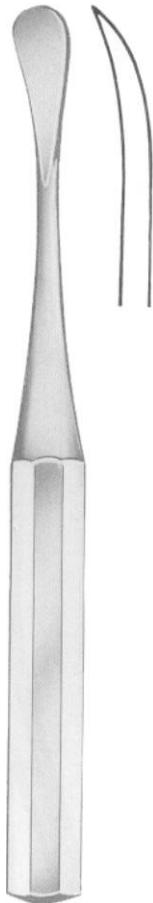

Cobb
24 cm/9½"



BI 14-3159-24
10 mm



BI 14-3160-24
13 mm



BI 14-3161-24
19 mm



BI 14-3162-24
25 mm





BI 14-3163-19
19 cm/7½"
6 mm



BI 14-31634-18
18.5 cm/7¼"
3 mm



BI 14-3165-18
18.5 cm/7¼"
6 mm



BI 14-3166-18
18.5 cm/7¼"
6 mm

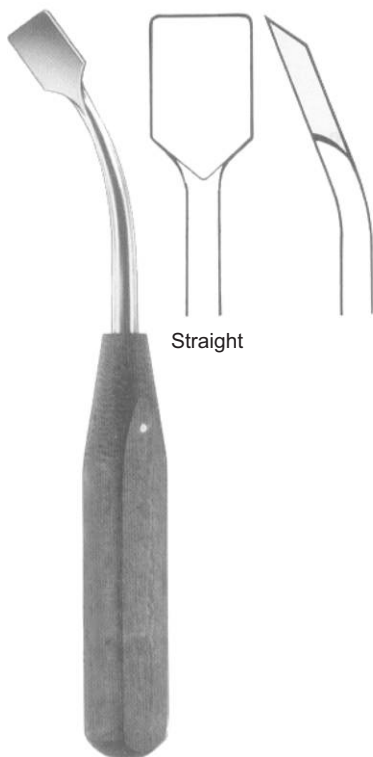

BI 14-3167-18
18.5 cm/7¼"
13 mm



BI 14-3168-19
19.5 cm/7¾"
14 mm



BI 14-3169-18
18.5 cm/7¼"
14 mm

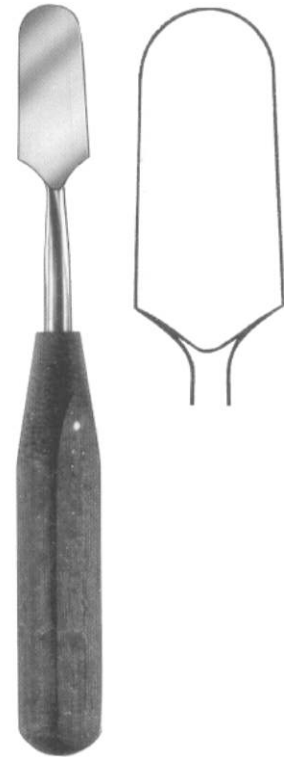

BI 14-3170-20
20 cm/8"
20 mm



BI 14-3171-27
27.5 cm/10¾"
20 mm



Wagner
8 mm BI 14-3172-33
17 mm BI 14-3173-33
33 cm/13"



Cobb
24 cm 28 cm
10 mm BI 14-3174-24 BI 14-3179-28
13 mm BI 14-3175-24 BI 14-3180-28
19 mm BI 14-3176-24 BI 14-3181-28
25 mm BI 14-3177-24 BI 14-3182-28
32 mm BI 14-3178-24 BI 14-3183-28



Cobb
08 mm BI 14-3184-28
10 mm BI 14-3185-28
12 mm BI 14-3186-28
28 cm/11"



Cobb
27.0cm
BI 14-3187-27 4mm
BI 14-3188-27 6mm
BI 14-3189-27 8mm



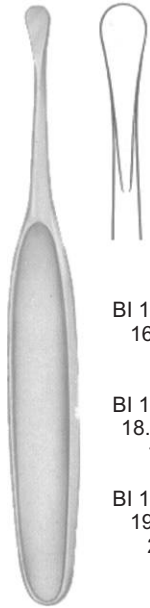

BI 14-3190-16
16 cm/6¼"
7 mm

BI 14-3190-18
18.5 cm/7¼"
15 mm

BI 14-3190-19
19 cm/7½"
20 mm

Hoen



Yankauer
BI 14-3191-18
18 cm/7"



Langenbeck
BI 14-3192-20
20 cm/8"
8 mm



Langenbeck
BI 14-3193-20
20 cm/8"
10 mm



Langenbeck
BI 14-3194-23
23 cm/9"
11 mm



Mass. Gen. Hosp.
BI 14-3195-15
15 cm/6"



Quervain
BI 14-3196-20
20 cm/8"

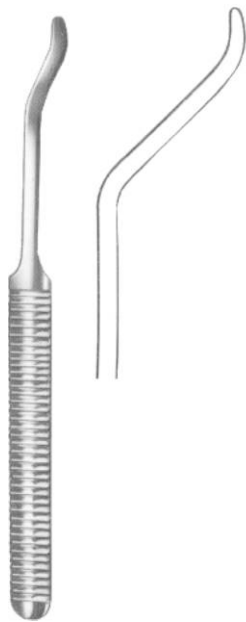

BI 14-3197-16
 16 cm/6 1/4"



Alderdyce
 BI 14-3204-21
 21 cm/8 1/4"

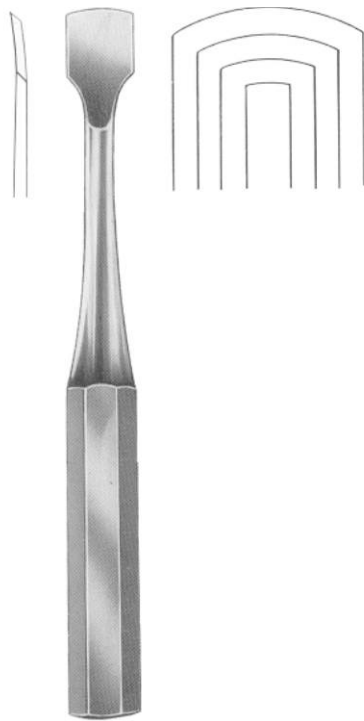

Width	Key	
6 mm	BI 14-3198-19	19 cm/7 1/2"
12 mm	BI 14-3199-19	19 cm/7 1/2"
19 mm	BI 14-3200-19	19 cm/7 1/2"
25 mm	BI 14-3201-19	19 cm/7 1/2"

McDonald
 BI 14-3205-19
 19 cm/7 1/2"

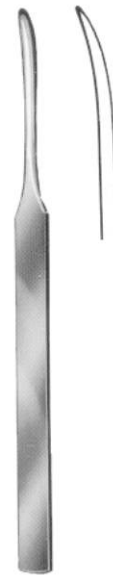

König
 BI 14-3202-15
 15 cm/6"
 4.5 mm

Watson-Cheyne
 BI 14-3206-17
 17.5 cm/7"



König
 BI 14-3203-15
 15 cm/6"
 4.5 mm



Sebilleau
 BI 14-3207-17
 17 cm/6 3/4"



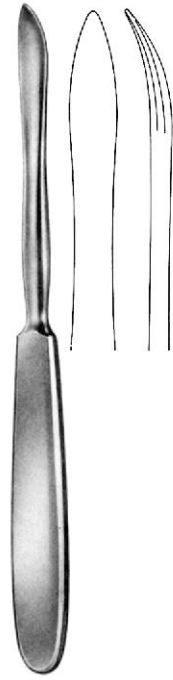

LANGENBECK
20 cm/8"
BI 14-3208-20 8mm
BI 14-3209-20 10mm



LANGENBECK

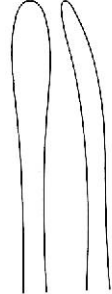

BI 14-3210-17
17 cm/6 1/2"
5mm

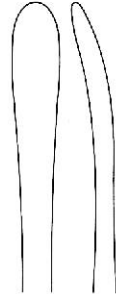

BI 14-3211-17
17 cm/6 1/2"
7mm



BI 14-3212-20
20 cm/8"
8mm



BI 14-3213-20
20 cm/8"
10mm

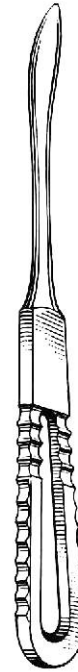

ST. THOMAS
BI 14-3214-18
18 cm/7"



WILLIGER
17 cm/6 3/4"



BI 14-3215-17



WILLIGER
16 cm/6 1/2"



BI 14-3216-16



LANE
 BI 14-3217-26
 26.5 cm/10 ½"



LANE TRETOWAN
 BI 14-3218-21
 21.5 cm/8 ½"



LANE
 BI 14-3219-25
 25.5 cm/10"



BRISTOW
 BI 14-3220-23
 23 cm/9"



MURPHY-LANE
 BI 14-3221-34
 34 cm/11 ½"



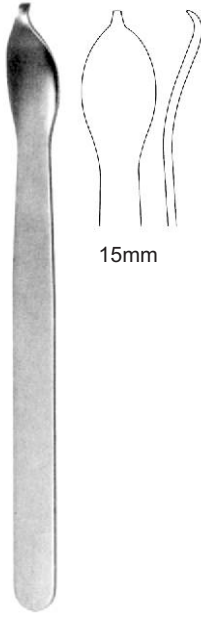

BI 14-3222-16
16 cm/6 1/2"



BI 14-3223-14
14 cm/5 1/2"
2.8 mm



BI 14-3224-14
14 cm/5 1/2"
5 mm

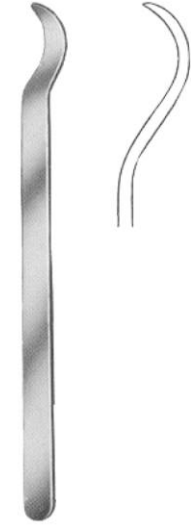

BI 14-3225-14
14 cm/5 1/2"
7 mm

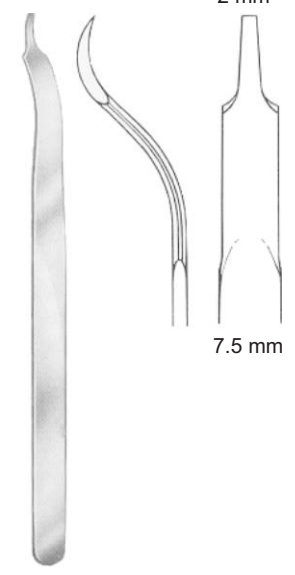

Buck-Gramcko
BI 14-3226-15
15 cm/6"

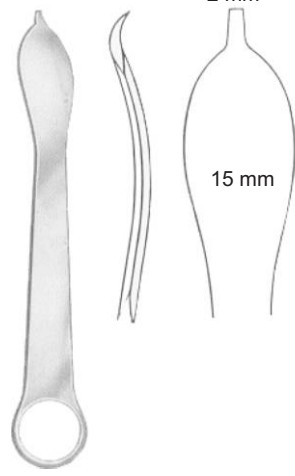

BI 14-3227-12
12.5 cm/5"

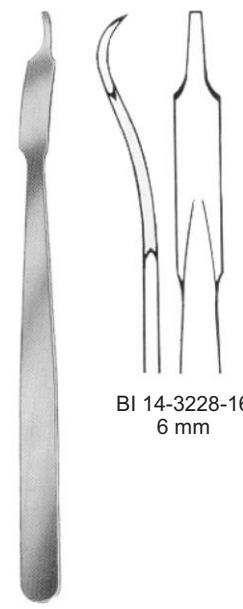

Mini-Hohmann
BI 14-3228-16
16 cm/6 1/4"



BI 14-3229-16
8 mm



BI 14-3230-16
16 cm/6 1/2"



BI 14-3231-17
17.5 cm/7"



BI 14-3236-17
 17 mm

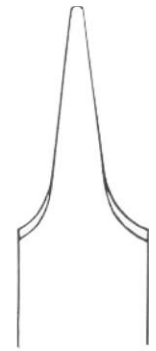

BI 14-3237-17
 17 mm

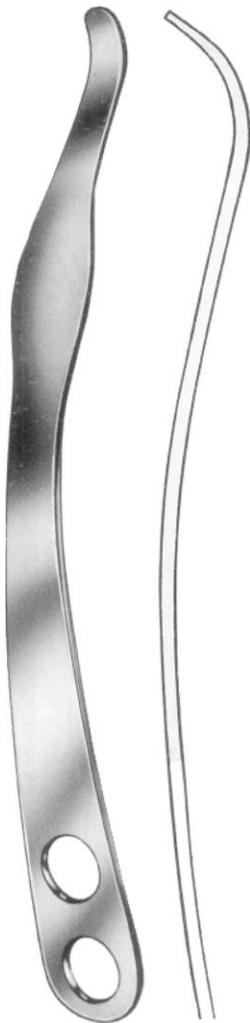

BI 14-3232-26
 26.5 cm/10½"
 24 mm



Lange-Hohmann
 BI 14-3233-26
 26 cm/10¼"
 22 mm



Hohmann
 BI 14-3234-22
 22 cm/8¾"
 8 mm

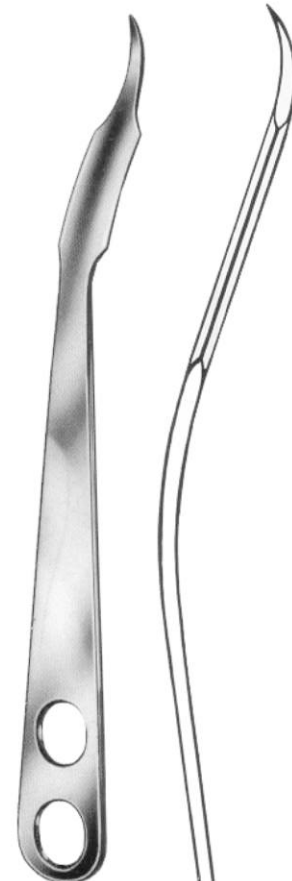

Hohmann
 BI 14-3235-24
 24 cm/9½"
 14 mm





Hohmann
BI 14-3238-26
26 cm/10 1/4"
22 mm



Hohmann
BI 14-3239-28
28 cm/11"
33 mm



Hohmann
BI 14-3240-24
24 cm/9 1/2"
43 mm



Hohmann
BI 14-3241-24
24.5 cm/9 3/4"
43 mm



Hohmann
BI 14-3242-24
24 cm/9 1/2"
70 mm



Hohmann
BI 14-3243-22
22 cm/8 3/4"
18 mm



Lange-Hohmann modif
 30 mm BI 14-3244-26 26.5 cm/10 1/2
 33 mm BI 14-3244-29 29.0 cm/11 1/2



Hohmann-Aldinger
 BI 14-3245-27
 27 cm/10 1/2"

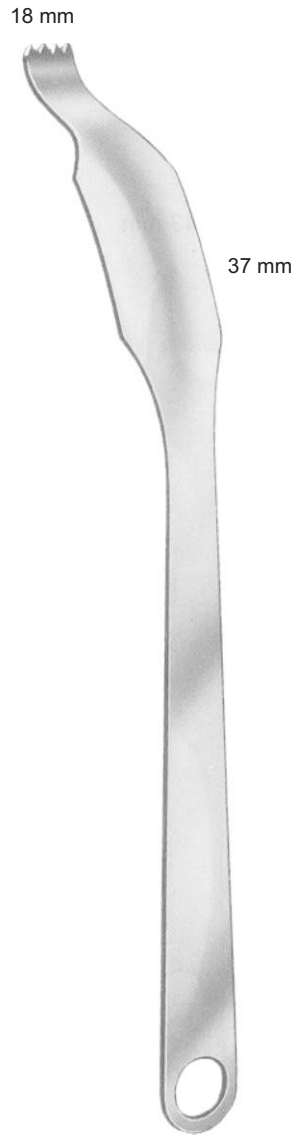

Schumacher
 (Wagner)
 BI 14-3246-34
 34.5 cm/13 1/2"



Schumacher
 BI 14-3247-29
 29 cm/11 1/2"



SM 14-3248-14
 32 x19 mm

SM 14-3251-14
 52 x13 mm

SM 14-3252-14
 12 x13 mm

SM 14-3249-14
 48 x19 mm

SM 14-3250-14
 57 x19 mm

Smillie
 14 cm/5½"

Spinal retractors

Meniscus retractors

SM 14-3253-17
 75x30 mm

SM 14-3254-17
 100x30 mm

Taylor
 17 cm/6½"

SM 14-3255-21
 21.5 cm/8½"

Blount
 SM 14-3256-17
 17.5 cm/7"

Murphy-Lane
 SM 14-3257-32
 32 cm/12½"

Length
 18 cm
 20 cm
 23 cm
 25 cm

Chandler
 Width
 13 mm
 19 mm
 25 mm
 30 mm

SM 14-3258-18
 SM 14-3258-20
 SM 14-3258-23
 SM 14-3258-25



Lange-Hohmann
 SM 14-3259-27 27 cm/10 ½"
 SM 14-3260-29 29 cm/11 ½"



Bennett
 SM 14-3261-24 24 cm/8 ½"
 SM 14-3262-26 26 cm/10 ½"



Blount
 SM 14-3263-26
 26 cm/10¼"

Blount
 SM 14-3264-26
 26 cm/10¼"

SM 14-3265-24 44 mm
 SM 14-3266-24 64 mm
Bennett
 24 cm/9½"

SM 14-3267-17
 17 cm/6 ¾", 56x10mm
 Retractor





Blillie
BI 14-3268-17
17 cm/6 3/4"



Blillie
BI 14-3269-17
17 cm/6 3/4"

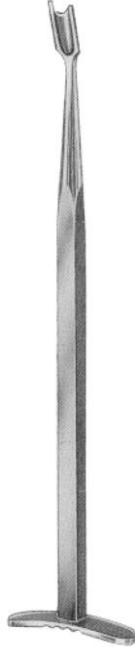

Blillie
BI 14-3270-17
17 cm/6 3/4"



Salenius
BI 14-3271-22
22 cm/8 3/4"



Salenius
BI 14-3272-22
22 cm/8 3/4"



Mod. Schweden
BI 14-3273-17
17 cm/6 3/4"



left cutting
BI 14-3273-17

right cutting
BI 14-3274-17



Lowe-Breck
BI 14-3275-25
25 cm/10"



Downing
BI 14-3276-25
25 cm/10"



BI 14-3277-17
17.5 cm/7"



Neff
BI 14-3278-21
21.5 cm/8 1/2"

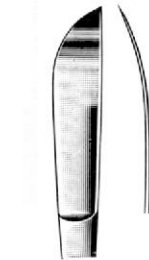

BI 14-3278-21
Left

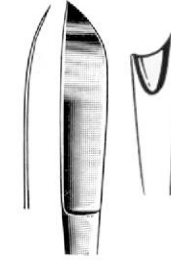

BI 14-3279-21
Right

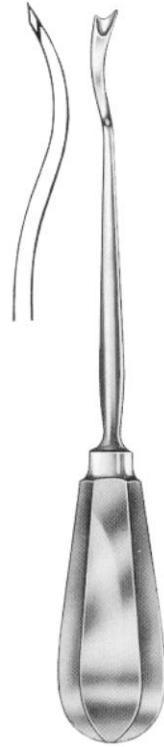

Canad-Modell
BI 14-3280-20 20 cm/8"



BI 14-3281-20



BIRCHER
BI 14-3282-19
19 cm/7 3/4"

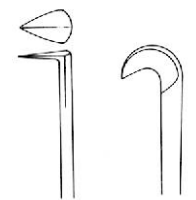

BI 14-3282-19
BI 14-3283-19

BONE SURGERY

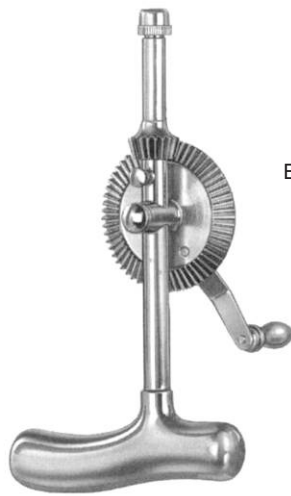

Stille
 20 cm/8"
 BI 14-3284-20 compl. set
 BI 14-3285-20 drill only

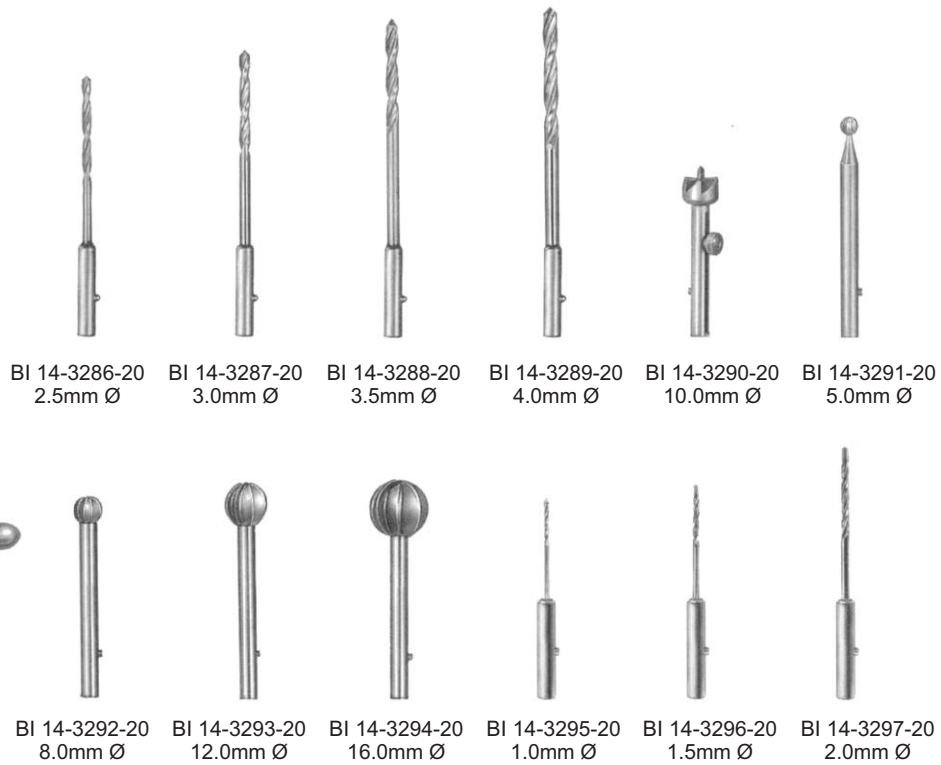



SM 14-3321-00

SM 14-3322-00

SM 14-3323-00

SM 14-3328-00 SM 14-3329-00

SM 14-3325-00

SM 14-3327-00

SM 14-3324-00 complete set

Kirschner
SM 14-3326-00 complete set

Bunnell
SM 14-3330-00

Ralk
SM 14-3331-00

Ralk-Universal
SM 14-3332-00 Left hand
SM 14-3333-00 Right hand

SM 14-3334-00



Spare Saw Blade
 BI 14-3335-12 12mm
 BI 14-3335-15 15mm
 BI 14-3335-18 18mm



Chaarriere
 BI 14-3336-35
 35 cm/14"

Spare Saw Blade
 BI 14-3337-03 3mm
 BI 14-3337-05 5mm
 BI 14-3337-07 7mm



Helferich-Bier
 BI 14-3338-39
 39 cm/15 3/4"



Lindemann
 BI 14-3339-20
 20 cm/8"



Langenbeck
 BI 14-3340-23
 23 cm/9"

BI 14-3341-06 6mm
 BI 14-3341-08 8mm
 BI 14-3341-12 12mm
 BI 14-3341-15 15mm
 BI 14-3341-18 18mm

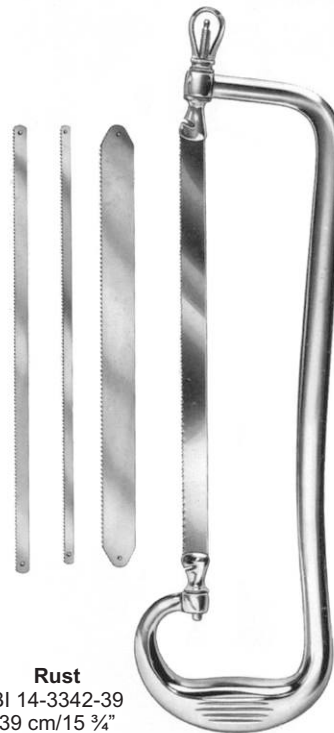

Rust
 BI 14-3342-39
 39 cm/15 3/4"

BONE SURGERY

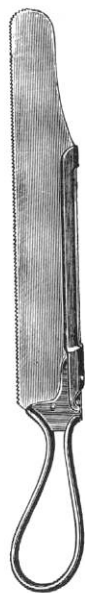

Charriere
 BI 14-3343-27 27 cm/11"
 BI 14-3343-30 30 cm/12"
 BI 14-3343-34 33 cm/13"

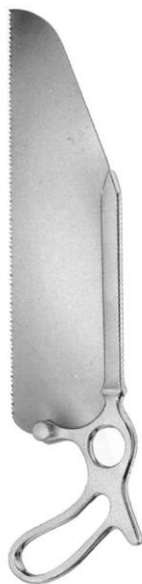

Satterlee
 BI 14-3344-31
 31 cm/12 1/2"



Charriere
 BI 14-3345-27 27 cm/11"
 BI 14-3345-30 30 cm/12"



Satterlee
 BI 14-3346-31
 31 cm/12 1/2"

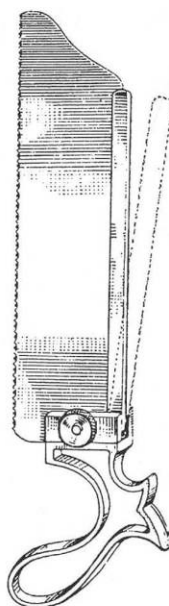

BI 14-3347-23
 23 cm/9"

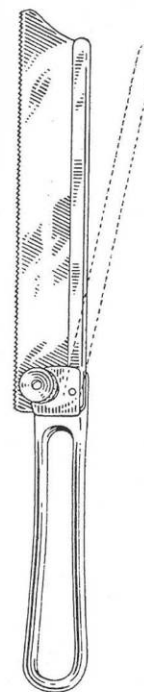

BI 14-3348-19
 19 cm/7 1/2"



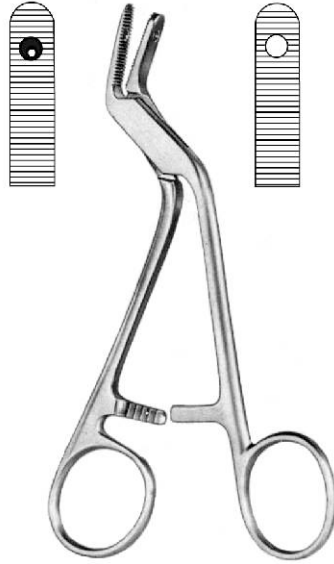

ADSON
BI 14-3349-15
15 cm/6"



LANE
BI 14-3350-18
18 cm/7"

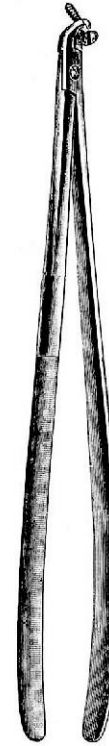

LANE
BI 14-3351-23
23 cm/9"

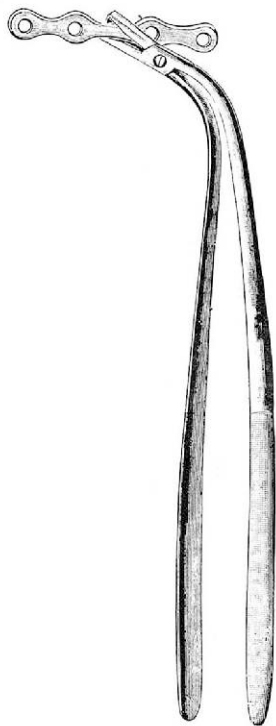

LANE
BI 14-3352-23
23 cm/9"

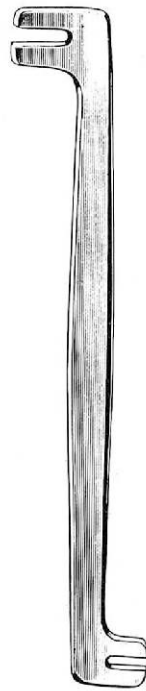

LANE
BI 14-3353-18
18 cm/7"



BI 14-3354-25
25.5 cm/10"

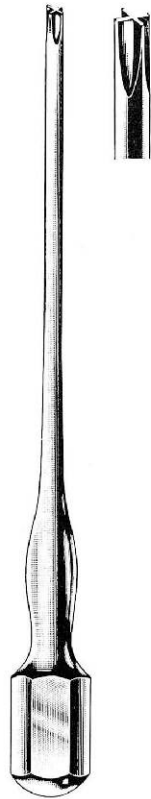

BI 14-3355-25
 25 cm/10"



PHILLIPS
 BI 14-3356-25 25 cm/10"



LANE
 BI 14-3357-17 17 cm/6 3/4"
 BI 14-3358-25 25 cm/10"



WILLIAMS
 BI 14-3359-24 Flat
 BI 14-3360-24 Cross Slot
 24 cm/9 1/2"





HEXAGONAL
BI 14-3361-25 2.5mm
BI 14-3362-25 3.5mm
BI 14-3363-25 4.5mm
25 cm/10"



PHILLIPS
BI 14-3364-25
25 cm/10"



BI 14-3365-25
25 cm/10"



LANE
BI 14-3366-17 17 cm/6 1/2"
BI 14-3367-25 25 cm/10"

BONE SURGERY



1/2
 BI 14-3368-14
 14.5 cm/5 1/2"



1/4
 BI 14-3369-00



BI 14-3370-00 Screw driver set, complete in case
 BI 14-3371-00 Sterilizing case only



1/4
 BI 14-3372-00



1/4
 BI 14-3373-00



1/4
 BI 14-3374-00



1/4
 BI 14-3375-00



2.5mm 3.5mm
 1/4
 BI 14-3376-00
 BI 14-3377-00





BI 14-3378-2
2.4mm



BI 14-3379-3
3.2mm



BI 14-3380-4
4.8mm



BI 14-3381-6
6.4mm



BI 14-3382-14
14 cm/5 1/2"



BI 14-3383-14
14 cm/5 1/2"



PERTHES
BI 14-3384-21
21 cm/8 1/2"

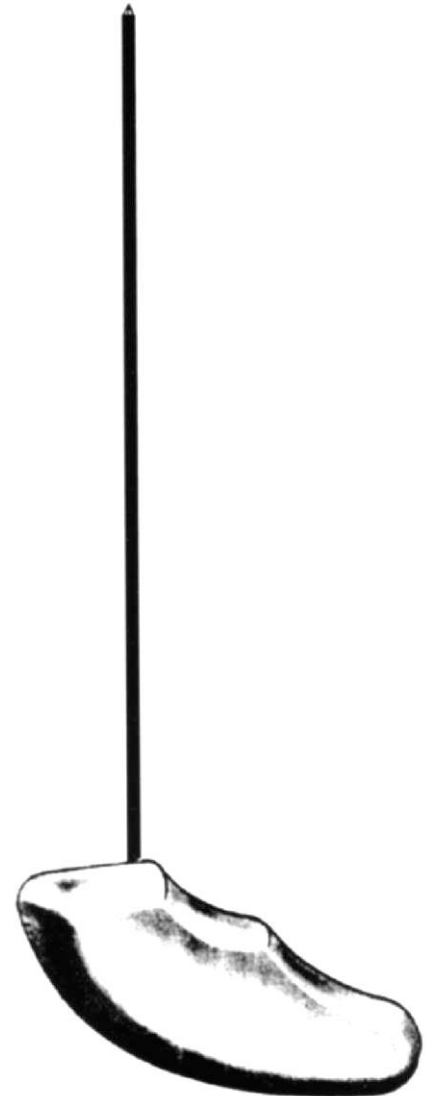

TABB
 BI 14-3385-02 2.4mm
 BI 14-3385-03 3.2mm
 BI 14-3385-04 4.8mm
 BI 14-3385-06 6.4mm

BONE SURGERY

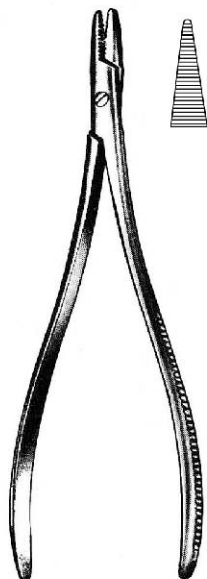

BI 14-3386-16
 16.5 cm/6 1/2"

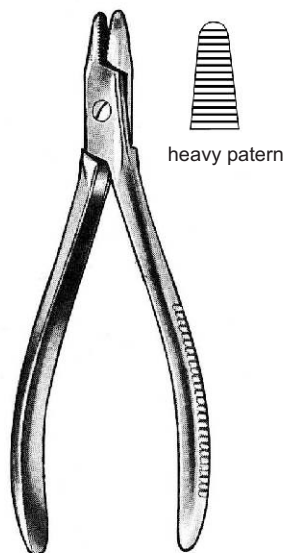

BI 14-3387-16
 16 cm/6 1/2"



BI 14-3388-15
 15 cm/6"



BI 14-3389-17
 17 cm/6 3/4"

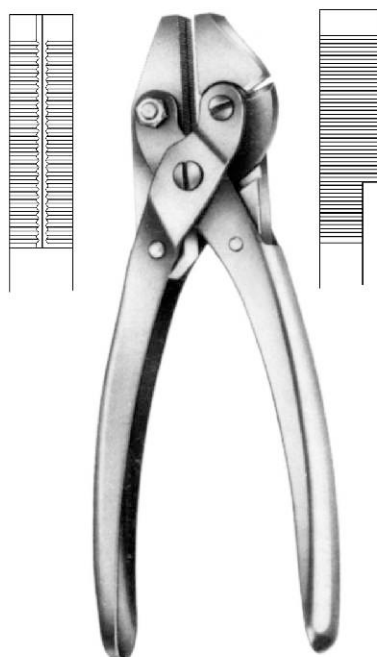

BI 14-3390-18
 18 cm/7"

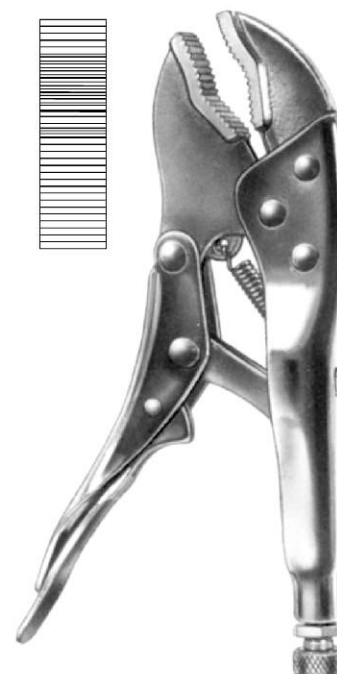

BI 14-3391-18
 18 cm/7"





17 cm/6 3/4"



BI 14-3392-17



BI 14-3393-17



18 cm/7"



BI 14-3394-18



BI 14-3395-18



BI 14-3396-18

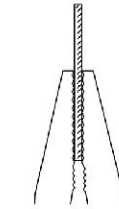

parallel action

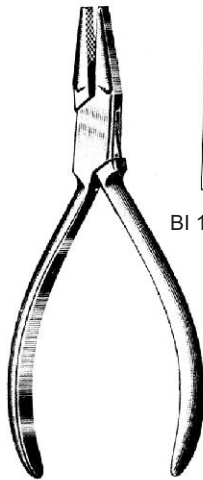

14 cm/5 1/2"



BI 14-3397-14



BI 14-3398-14



BI 14-3399-16
16 cm/6 1/4"

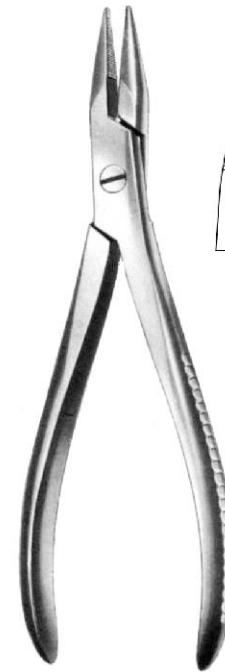
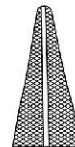

BI 14-3400-19
19.5 cm/7 3/4"



BONE SURGERY



PARHAM

BI 14-3401-18 18 cm/7"
 BI 14-3401-20 20 cm/8"
 BI 14-3401-25 25 cm/10"
 BI 14-3401-30 30 cm/12"



PARHAM

BI 14-3402-22
 22 cm/9 3/4"

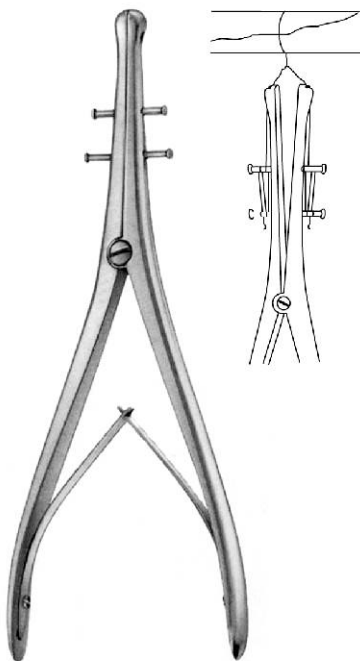

DEMEL

BI 14-3403-28
 28 cm/11"

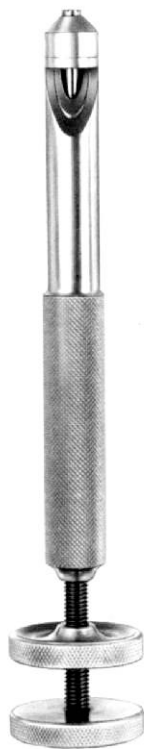

LOUTE

BI 14-3404-21
 21 cm/8 1/4"

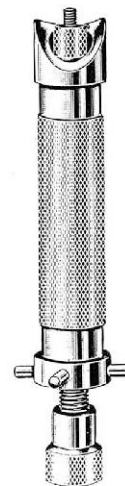

LLOYD

BI 14-3405-00





	soft	hard
0.2mm Ø	BI 14-3406-02	
0.3mm Ø	BI 14-3406-03	BI 14-3407-03
0.4mm Ø	BI 14-3406-04	BI 14-3407-04
0.5mm Ø	BI 14-3406-05	
0.6mm Ø	BI 14-3406-06	BI 14-3407-06
0.7mm Ø	BI 14-3406-07	
0.8mm Ø	BI 14-3406-08	BI 14-3407-08
0.9mm Ø	BI 14-3406-09	
1.0mm Ø	BI 14-3406-10	BI 14-3407-10
1.2mm Ø	BI 14-3406-12	
1.5mm Ø	BI 14-3406-15	

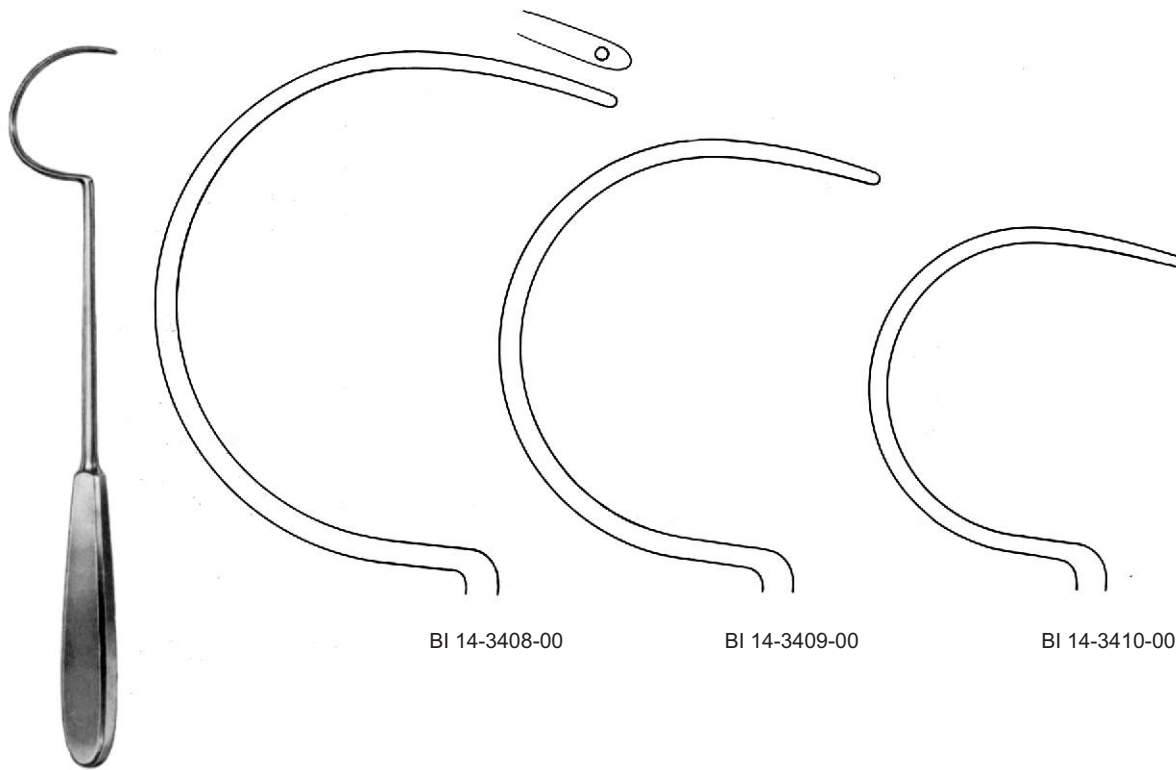

BI 14-3408-00

BI 14-3409-00

BI 14-3410-00

DEMEL



KUENTSCHER
 BI 14-3411-21
 21 cm/8 1/4"

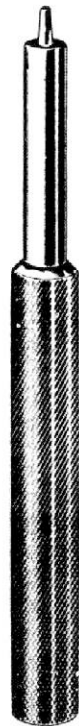

KUENTSCHER
 BI 14-3412-21
 21 cm/8 1/4"



KUENTSCHER
 BI 14-3413-63
 63 cm/26"
 complete set

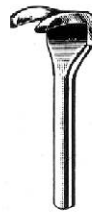

BI 14-3414-63



BI 14-3417-63

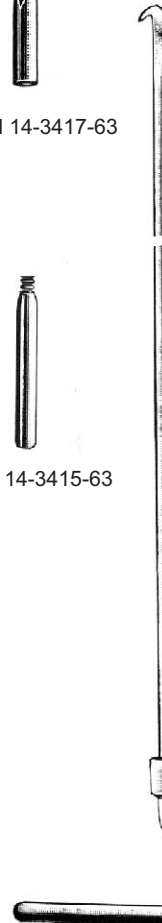

BI 14-3418-29 29 cm/11 3/4"
 BI 14-3418-37 37 cm/15"
 BI 14-3418-42 42 cm/16 3/4"
 BI 14-3418-49 49 cm/19 3/4"

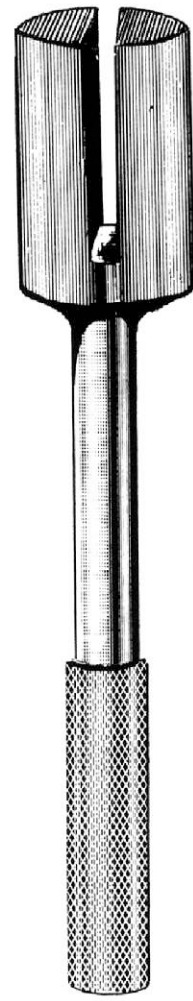

BI 14-3419-00



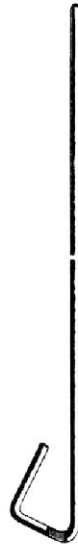

	L=35cm	L=46cm	L=60cm	
2.5mm Ø	BI 14-3420-25	BI 14-3421-25		
3.0mm Ø	BI 14-3420-30	BI 14-3421-30		
3.5mm Ø	BI 14-3420-35	BI 14-3421-35	BI 14-3422-35	
4.0mm Ø	BI 14-3420-40	BI 14-3421-40	BI 14-3422-40	
5.0mm Ø	BI 14-3420-50	BI 14-3421-50	BI 14-3422-50	

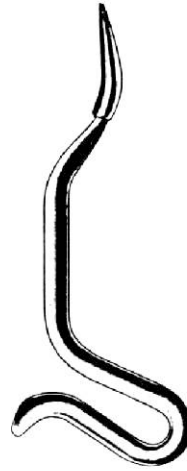

KUENTSCHER
 BI 14-3423-25
 25.5 cm/10"

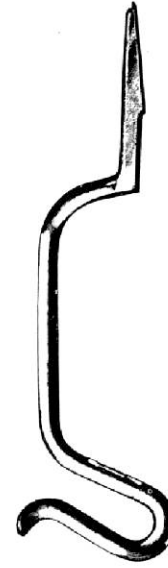

KUENTSCHER
 BI 14-3424-35
 35 cm/14"



STEINMANN
 4mm Ø (Trocar tip)
 BI 14-3425-14 140mm
 BI 14-3425-16 160mm
 BI 14-3425-18 180mm
 BI 14-3425-20 200mm



SCHANZ
 4mm Ø (Flat tip)
 BI 14-3426-06 60mm
 BI 14-3426-08 80mm
 BI 14-3426-10 100mm



SCHANZ
 6mm Ø (Flat tip)
 BI 14-3427-10 100mm
 BI 14-3427-13 130mm
 BI 14-3427-16 160mm
 BI 14-3427-19 190mm



SCHANZ
 5mm Ø (Trocar tip)
 BI 14-3428-10 100mm
 BI 14-3428-12 125mm
 BI 14-3428-15 150mm
 BI 14-3428-17 170mm
 BI 14-3428-20 200mm
 BI 14-3428-25 250mm

BONE SURGERY

KIRSCHNER
 trocar point
 flat end



mm ø	60 mm	120mm	140mm	160mm	310mm
0.6	BI 14-3429-06				
0.8	BI 14-3429-08				
1.0	BI 14-3429-10	BI 14-3430-10	BI 14-3431-10	BI 14-3432-10	BI 14-3433-10
1.2	BI 14-3429-12	BI 14-3430-12	BI 14-3431-12	BI 14-3432-12	BI 14-3433-12
1.4	BI 14-3429-14	BI 14-3430-14	BI 14-3431-14	BI 14-3432-14	BI 14-3433-14
1.5	BI 14-3429-15	BI 14-3430-15	BI 14-3431-15	BI 14-3432-15	BI 14-3433-15
1.6	BI 14-3429-16	BI 14-3430-16	BI 14-3431-16	BI 14-3432-16	BI 14-3433-16
1.8	BI 14-3429-18	BI 14-3430-18	BI 14-3431-18	BI 14-3432-18	BI 14-3433-18
2.0	BI 14-3429-20	BI 14-3430-20	BI 14-3431-20	BI 14-3432-20	BI 14-3433-20
2.2	BI 14-3429-22	BI 14-3430-22	BI 14-3431-22	BI 14-3432-22	BI 14-3433-22
2.5	BI 14-3429-25	BI 14-3430-25	BI 14-3431-25	BI 14-3432-25	BI 14-3433-25

KIRSCHNER
 trocar point
 round end



mm ø	60 mm	120mm	140mm	160mm	310mm
1.0	BI 14-3434-10	BI 14-3435-10	BI 14-3436-10	BI 14-3437-10	BI 14-3438-10
1.2	BI 14-3434-12	BI 14-3435-12	BI 14-3436-12	BI 14-3437-12	BI 14-3438-12
1.4	BI 14-3434-14	BI 14-3435-14	BI 14-3436-14	BI 14-3437-14	BI 14-3438-14
1.5	BI 14-3434-15	BI 14-3435-15	BI 14-3436-15	BI 14-3437-15	BI 14-3438-15
1.6	BI 14-3434-16	BI 14-3435-16	BI 14-3436-16	BI 14-3437-16	BI 14-3438-16
1.8	BI 14-3434-18	BI 14-3435-18	BI 14-3436-18	BI 14-3437-18	BI 14-3438-18
2.0	BI 14-3434-20	BI 14-3435-20	BI 14-3436-20	BI 14-3437-20	BI 14-3438-20
2.2	BI 14-3434-22	BI 14-3435-22	BI 14-3436-22	BI 14-3437-22	BI 14-3438-22
2.5	BI 14-3434-25	BI 14-3435-25	BI 14-3436-25	BI 14-3437-25	BI 14-3438-25

KIRSCHNER
 lancet point
 flat end



mm ø	100 mm
1.0	BI 14-3439-10
1.2	BI 14-3439-12
1.5	BI 14-3439-15
1.6	BI 14-3439-16
1.8	BI 14-3439-18
2.0	BI 14-3439-20
2.2	BI 14-3439-22
2.5	BI 14-3439-25



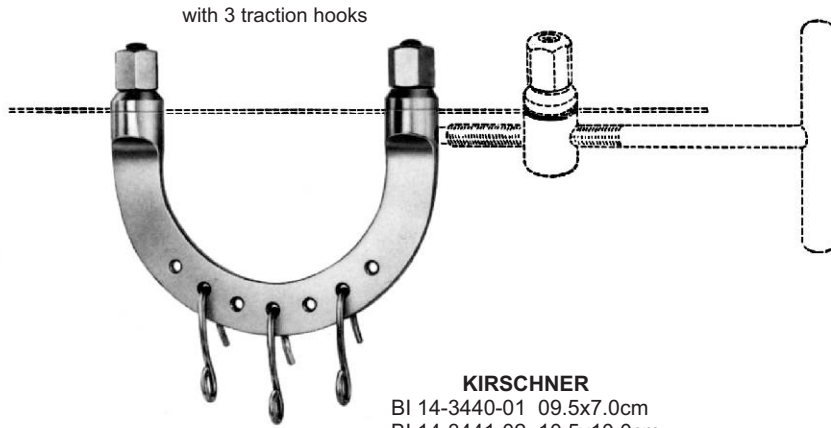

with 3 traction hooks

KIRSCHNER

- BI 14-3440-01 09.5x7.0cm
- BI 14-3441-02 10.5x10.0cm
- BI 14-3442-03 12.0x12.0cm
- BI 14-3443-04 15.5x15.5cm
- BI 14-3444-05 20.0x15.5cm

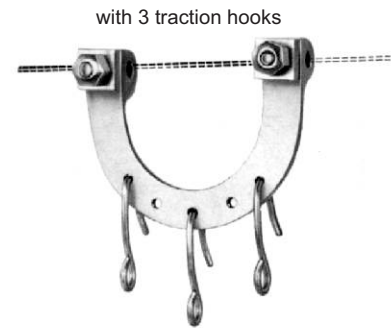

with 3 traction hooks

- KIRSCHNER**
 BI 14-3445-01
 6.0x6.0cm

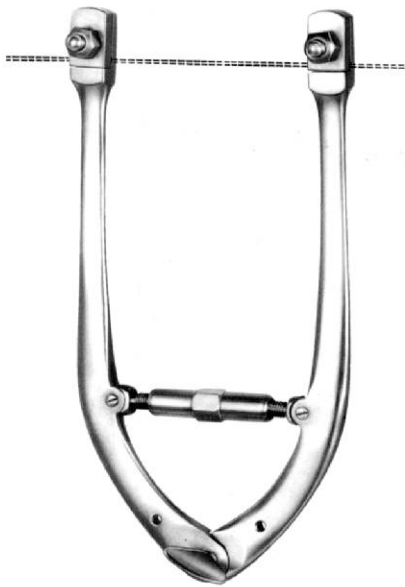

- BI 14-3446-18 18.0x10.0cm
- BI 14-3446-27 27.0x27.0cm

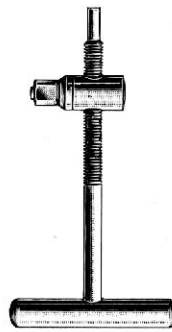

- BI 14-3447-18



- BI 14-3448-19
 19.0cm



- BI 14-3449-03 BI 14-3450-06

BONE SURGERY

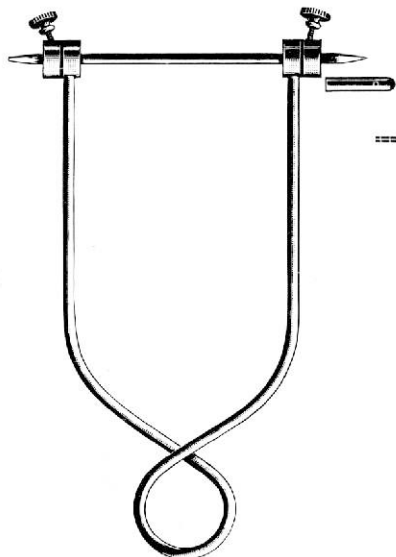

BÖHLER
 BI 14-3451-15 21.0x15.0cm
 BI 14-3451-16 16.0x 9.0cm
 BI 14-3451-21 21.0x11.0cm



KIRSCHNER
 BI 14-3452-13 13.5cm, infant
 BI 14-3452-18 18.5cm, child
 BI 14-3452-27 27.0cm, adult



MARTIN-DIAMANT
 BI 14-3453-16
 16 cm/6 1/4"



BI 14-3454-16
 16 cm/6 1/4"



BI 14-3455-15
 15 cm/6"



BI 14-3456-23
 23 cm/9"



BI 14-3456-25
 25 cm/10"



BI 14-3457-24
 24 cm/9 1/4"



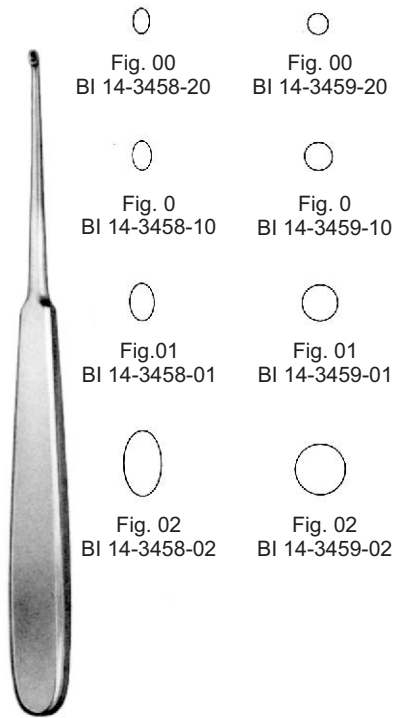

WILLIGER
17.5 cm/7"

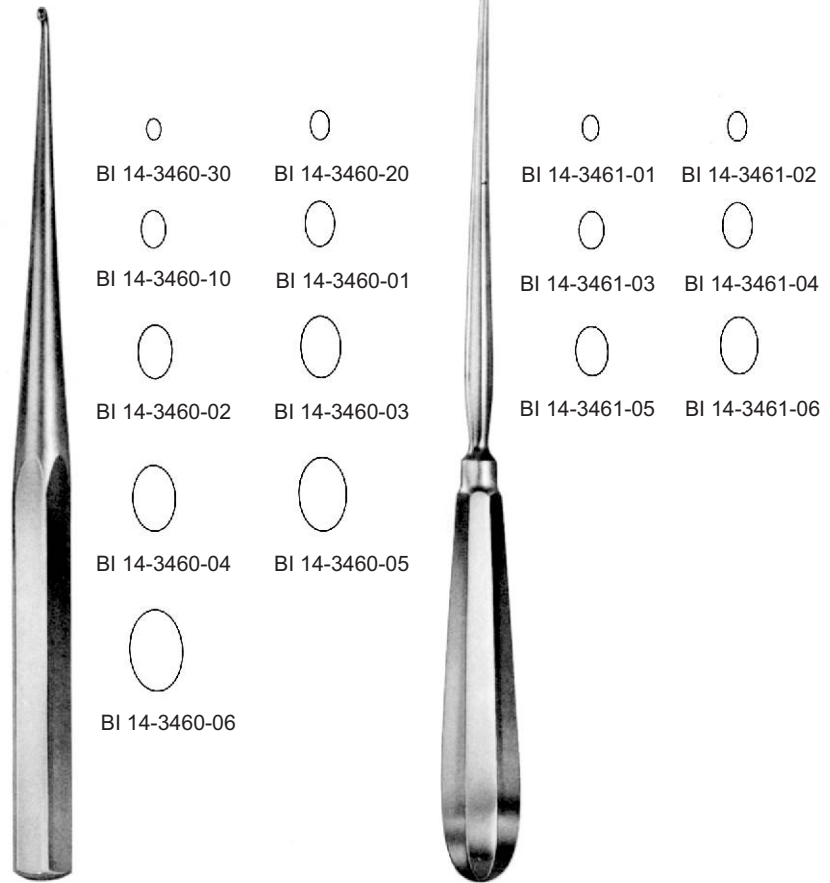

BRUNS
23 cm/9"

SIMON
24 cm/9 1/4"



MOD. USA
 16 cm/6 1/4"

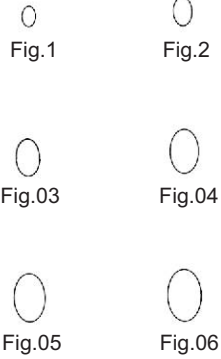

Fig.1 BI 14-3462-01
 Fig.2 BI 14-3462-02
 Fig.3 BI 14-3462-03
 Fig.4 BI 14-3462-04
 Fig.5 BI 14-3462-05
 Fig.6 BI 14-3462-06



BI 14-3463-01
 BI 14-3463-02
 BI 14-3463-03
 BI 14-3463-04
 BI 14-3463-05
 BI 14-3463-06



BI 14-3464-01
 BI 14-3464-02
 BI 14-3464-03
 BI 14-3464-04
 BI 14-3464-05
 BI 14-3464-06



LEMPERT
 17.5 cm/7"

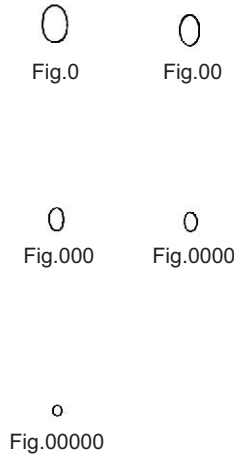
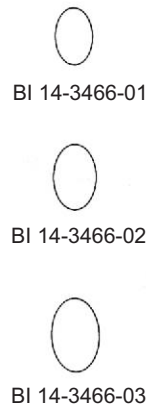

Fig.0 BI 14-3465-10
 Fig.00 BI 14-3465-20
 Fig.000 BI 14-3465-30
 Fig.0000 BI 14-3465-40
 Fig.00000 BI 14-3465-50



HALLE
 21 cm/8 1/4"



25 cm/10"





VOLKMANN
17 cm/7"

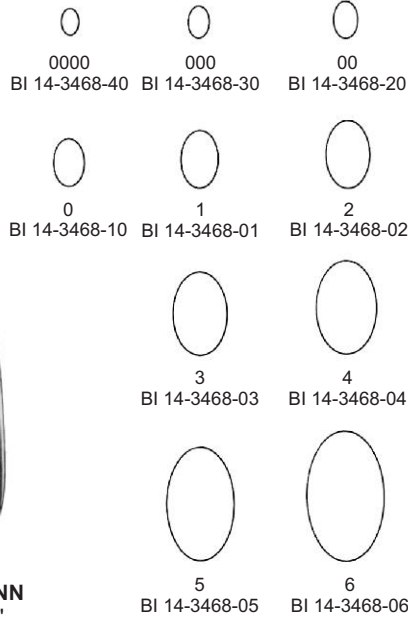

BRUNS
17 cm/7"

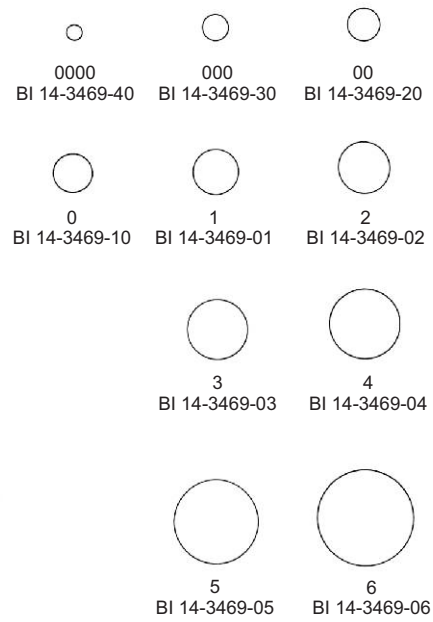

SCHEDE
17 cm/7"

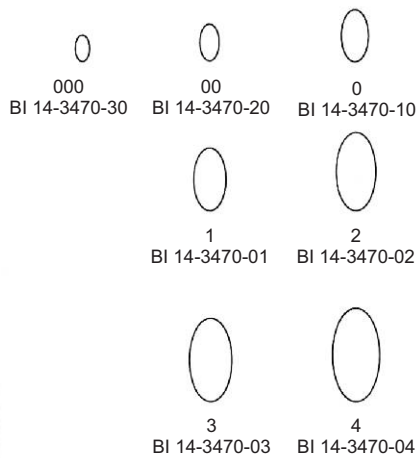

SPRATT
16.5 cm/6 3/4"

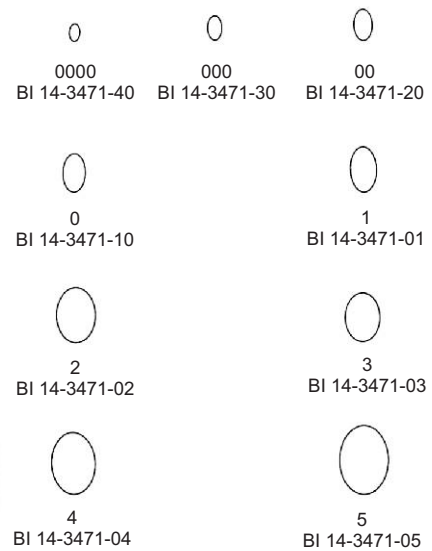



WILLIGER
 13.5 cm/5 ¼"

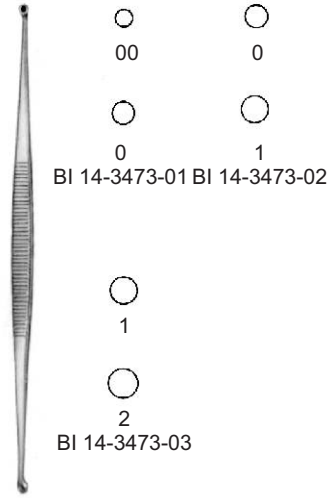

MARTINI
 13.5 cm/5 ¼"

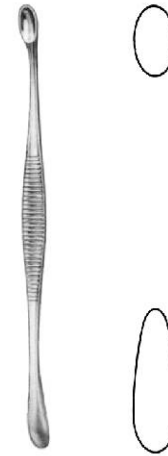

VOLKMANN
 BI 14-3474-13 13 cm/5"
 BI 14-3474-14 14 cm/5 ½"
 BI 14-3474-17 17 cm/7"



VOLKMANN
 BI 14-3475-13 13 cm/5 ¼"
 BI 14-3475-16 16 cm/6 ¼"
 BI 14-3475-20 20 cm/8"



BI 14-3476-21
 21 cm/8 ¼"

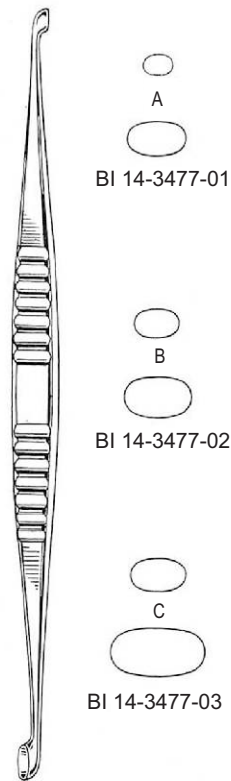

VOLKMANN
 21.5 cm/8 ½"





VOLKMANN
17 cm/6 3/4"

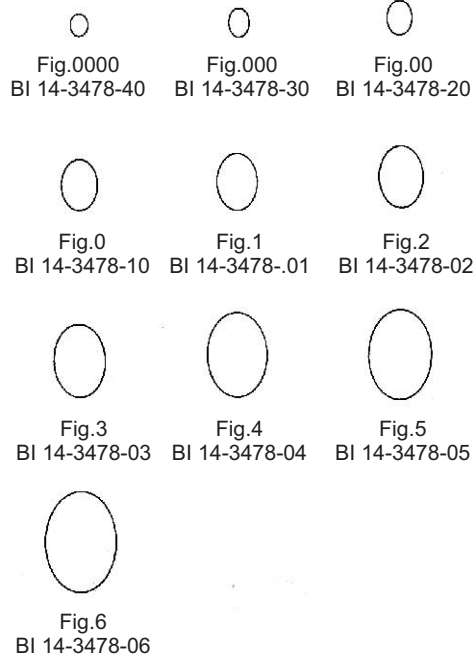



VOLKMANN
 27 cm/10 3/4"

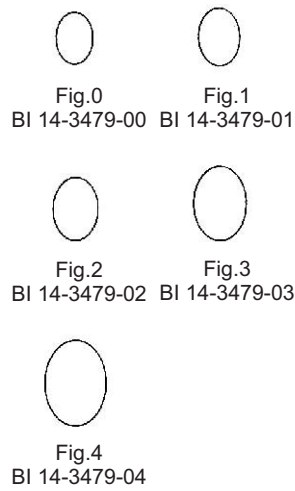



Martin
BI 14-3482-19
19 cm/7½"



Preston
BI 14-3483-18
18 cm/7¼"

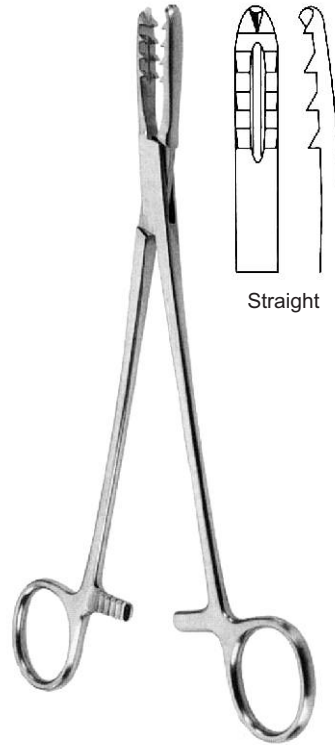

Straight

Bircher-Ganske
BI 14-3484-20
20 cm/8"

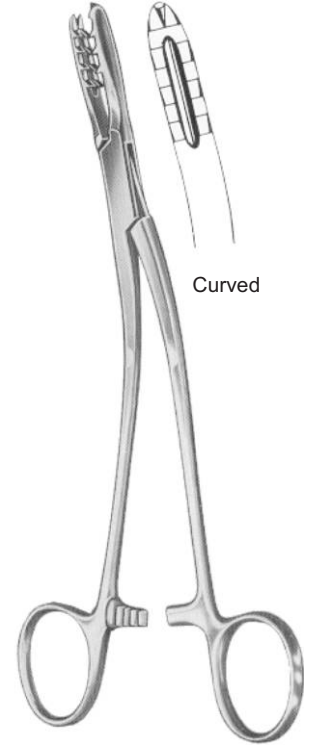

Curved

Bircher-Ganske
BI 14-3485-20
20 cm/8"



Lewin
BI 14-3486-17
17.5 cm/7"



Langenbeck
BI 14-3487-21
21 cm/8¼"



Fergusson
BI 14-3488-21
21 cm/8¼"

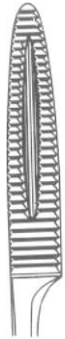

Straight
 BI 14-3489-20
 20 cm/8"

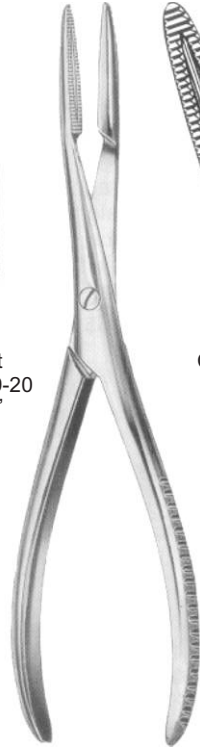
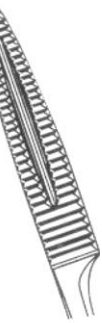
Curved on Falt
 BI 14-3490-20
 20 cm/8"



Van Buren
 BI 14-3491-23
 23 cm/9"



Dingmann
 BI 14-3492-19
 19cm/7 1/2"



Dingmann Modif
 BI 14-3493-19
 19 cm/7 1/4"



Neff
 BI 14-3494-21
 21 cm/8 1/4"





Semb
BI 14-3495-19
19 cm/7½"



Semb
BI 14-3496-19
19 cm/7½"



Verbrugge
BI 14-3497-17
17.5 cm/7"

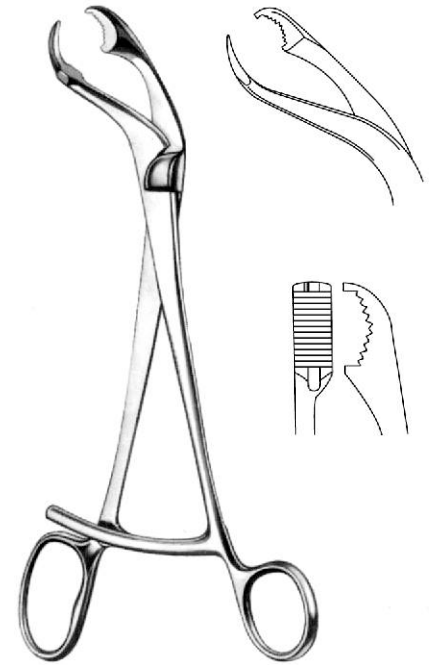

Verbrugge
BI 14-3498-17
17.5 cm/7"



BI 14-3499-25
25 cm/10"

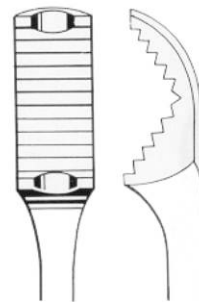
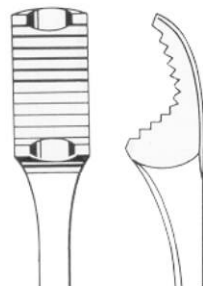

BI 14-3499-26
26 cm/10¼"
Vebrugge

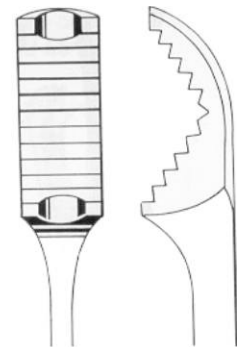

BI 14-3499-27
27 cm/10½"



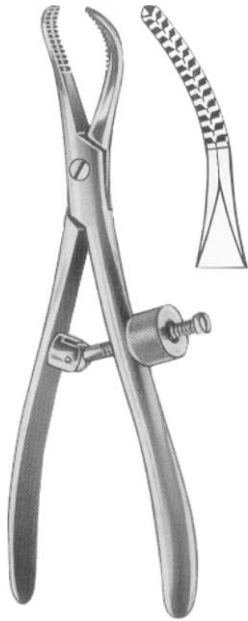

BI 14-3501-16
 16 cm/6¼"
 BI 14-3501-24
 24 cm/9½"

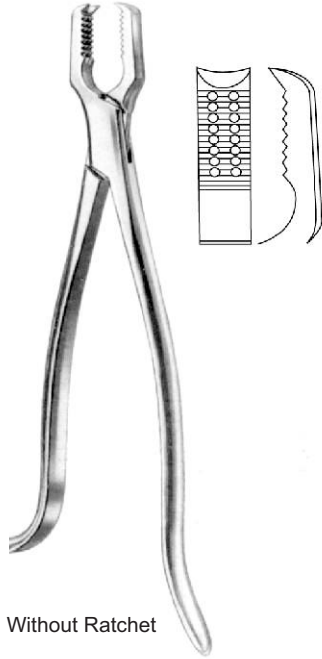

Without Ratchet
 BI 14-3502-17
 BI 14-3502-21

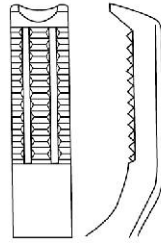

Kern
 cm in
 17 6¾"
 21 8¼"

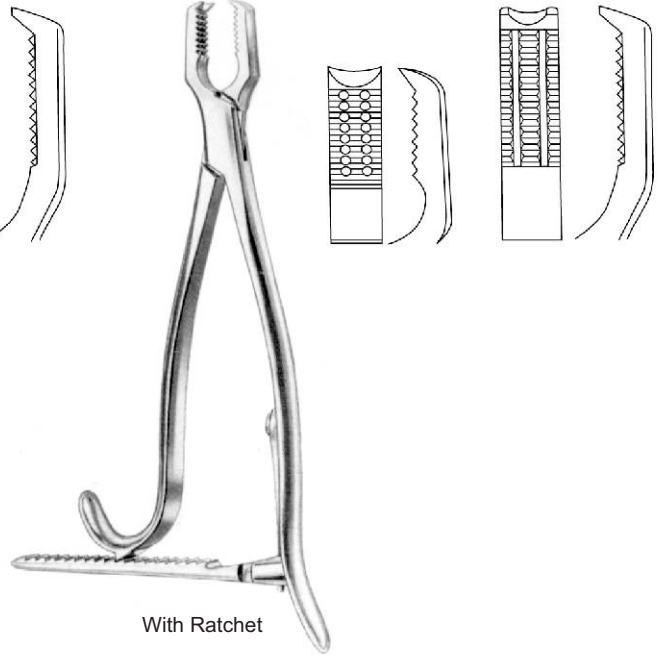

With Ratchet
 BI 14-3503-17
 BI 14-3503-21

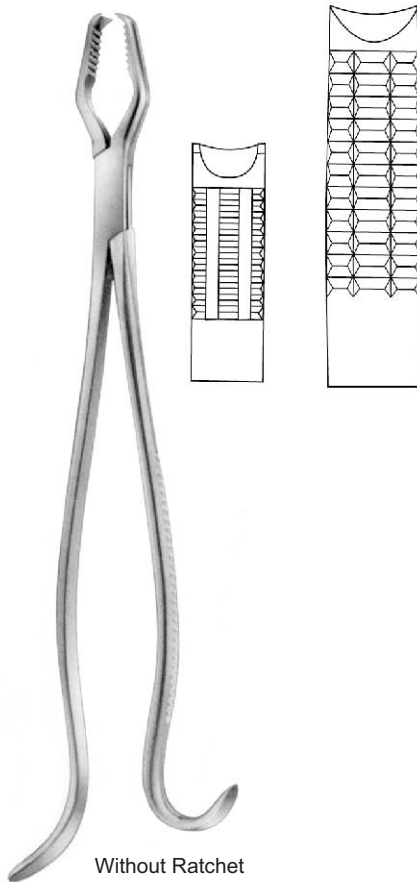

Without Ratchet
 BI 14-3504-33
 BI 14-3504-45

Lane
 cm in
 33 13"
 45 17¾"

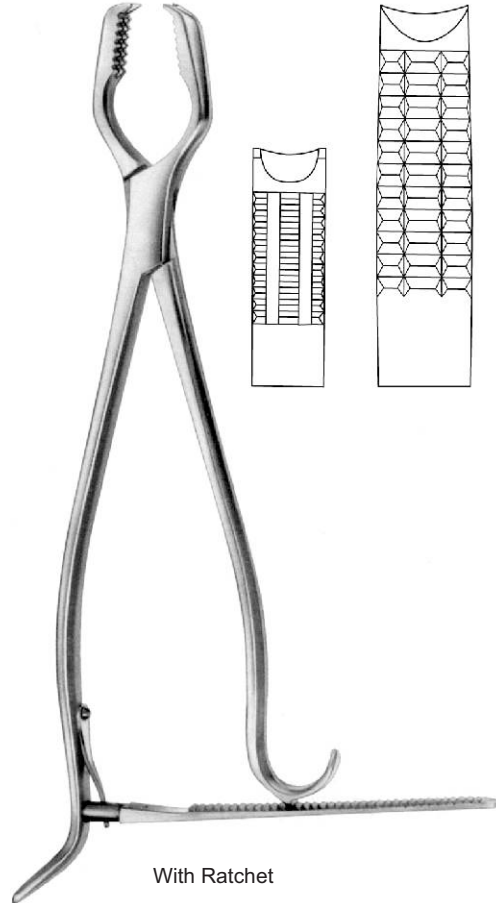

With Ratchet
 BI 14-3505-33
 BI 14-3505-45





ULRICH

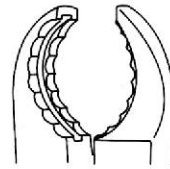
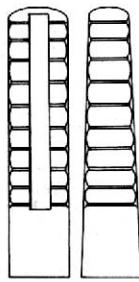

BI 14-3506-23 23.0cm
BI 14-3507-22 22.0cm

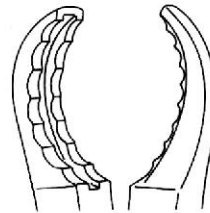

BI 14-3506-25 25.0cm
BI 14-3507-24 24.0cm

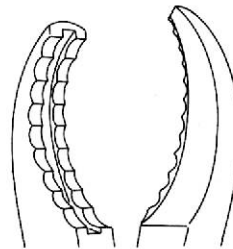

BI 14-3506-28 28.0cm
BI 14-3507-27 27.0cm



ULRICH



BI 14-3508-19 19 cm/8 3/4"
 BI 14-3508-26 26 cm/10 1/4"



ULRICH
 BI 14-3508-28
 28 cm/11"





Farabeuf-Lambotte
BI 14-3509-26
26 cm/10 1/4"



Lambotte
BI 14-3510-19 19 cm/7 1/2"
BI 14-3510-23 23 cm/9"
BI 14-3510-26 26 cm/10 1/4"



BI 14-3511-13
13.5 cm/5 1/4"

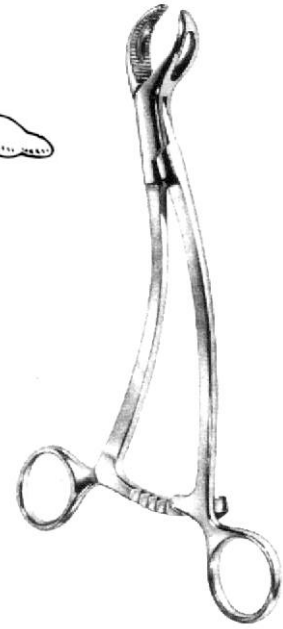

Bruns
BI 14-3511-18
18.5 cm/7 1/4"



BI 14-3511-14
14.5 cm/5 3/4"



BI 14-3512-12
12 cm/4 3/4"



BI 14-3512-21
21 cm/8 1/4"



BI 14-3512-14
14 cm/5 1/2"

BONE SURGERY



BI 14-3513-15 15 cm/6"
 BI 14-3513-19 19 cm/7 ½"
 BI 14-3513-24 24 cm/9 ½"
 BI 14-3513-26 26 cm/10 ¼"
 BI 14-3513-28 28 cm/11"

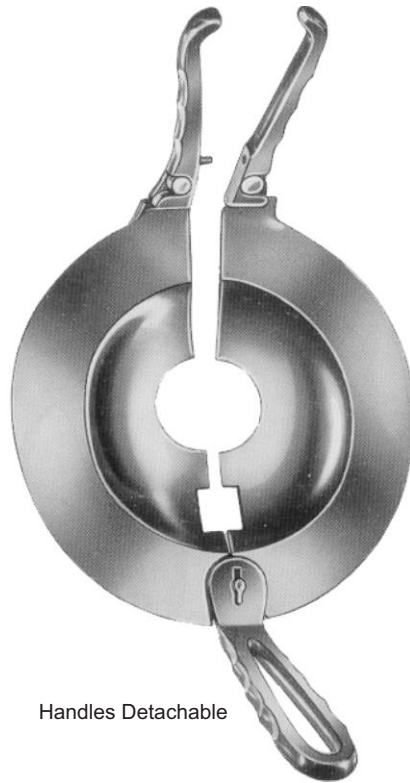

Handles Detachable

Percy
 BI 14-3514-30

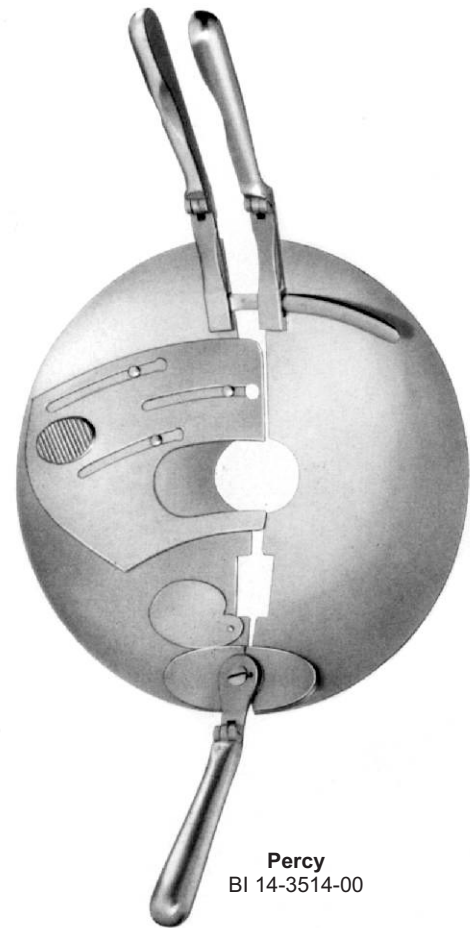

Percy
 BI 14-3514-00



Adjustable

Lambotte
 BI 14-3515-22 22 cm/8 ¾"
 BI 14-3515-27 27 cm/10 ½"
 BI 14-3515-30 30 cm/12"



Farabeuf
 BI 14-3516-23 23 cm/9"
 BI 14-3516-26 26 cm/10 ¼"



Lambotte
 BI 14-3517-22 22.5 cm/9"
 BI 14-3517-25 25.5 cm/10 ½"
 BI 14-3517-33 33 cm/13 ½"

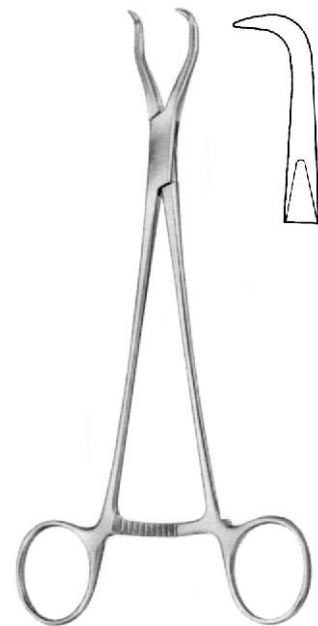

Haase
 BI 14-3517-16
 16.5 cm/6 ½"

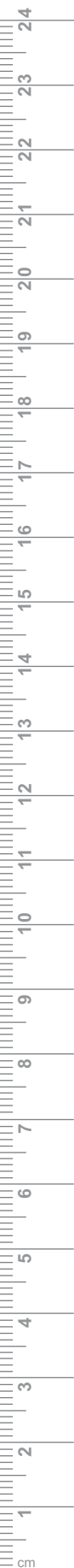



BI 14-3518-19
19 cm/7 3/4"



BI 14-3519-23
23 cm/9"



BI 14-3520-25
25 cm/10"

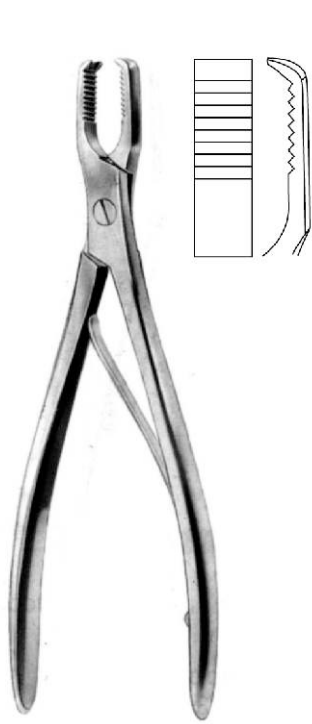

FROSCH
 BI 14-3521-18
 18 cm/7"

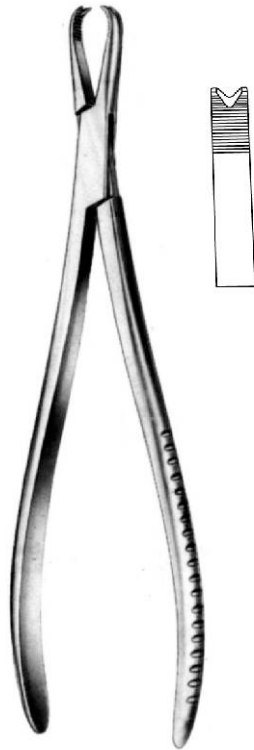

BI 14-3522-20
 20 cm/8"



BI 14-3523-18
 18.5 cm/7 1/2"

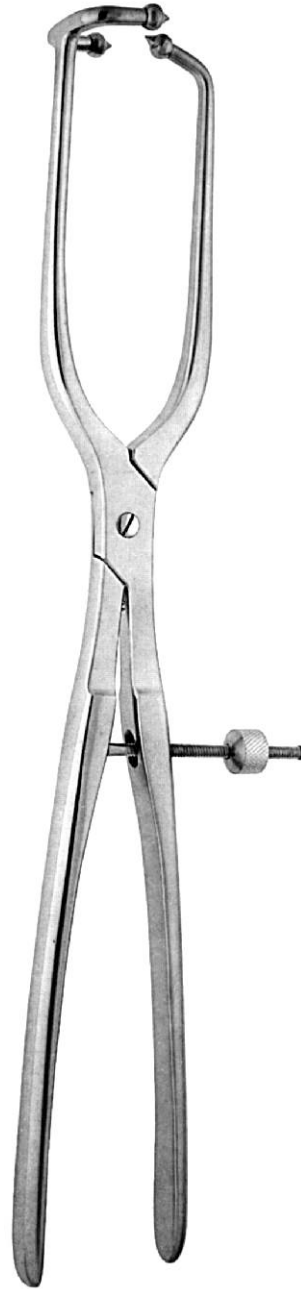

BI 14-3524-40
 40 cm/16"

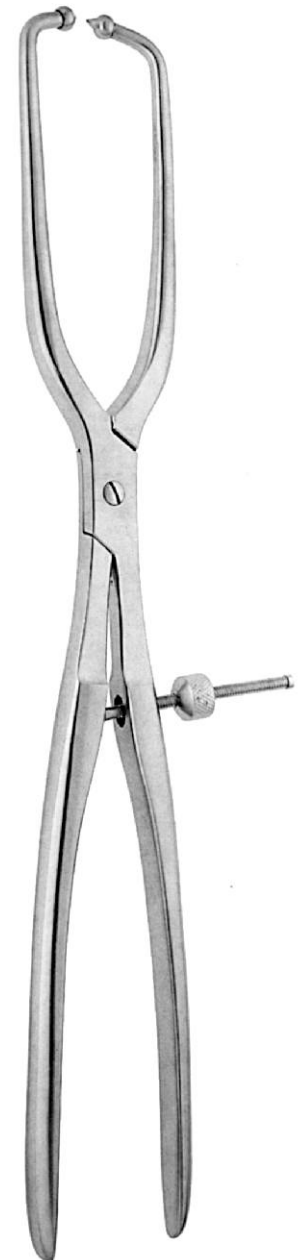

BI 14-3525-40
 40 cm/16"





TUFFIER
BI 14-3526-27
27 cm/10 3/4"



BI 14-3527-19 19 cm/7 3/4"
BI 14-3527-26 26 cm/10 1/4"

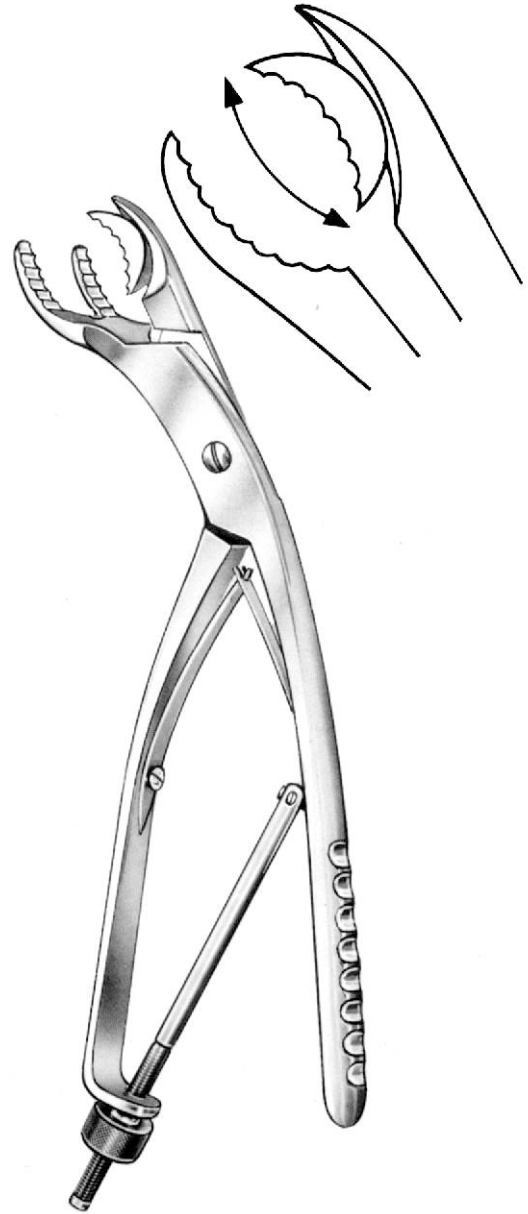

ULRICH
BI 14-3528-28
28 cm/11"

BONE SURGERY



BI 14-3529-13
 13.5 cm/5¼"



BI 14-3530-20
 20 cm/8"





Reall
BI 14-3531-17
17 cm/6¾"

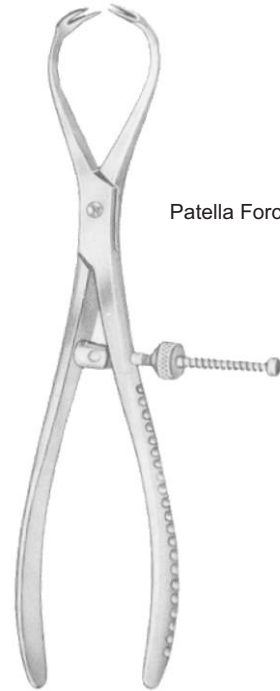

Patella Forceps

BI 14-3532-17
17.5 cm/7"



LOWMAN
 BI 14-3533-12 12.0cm
 BI 14-3533-18 18.5cm
 BI 14-3533-20 20.0cm
 BI 14-3533-22 22.0cm

GERSTER-LOWMANN
 BI 14-3534-18 18.0cm
 BI 14-3534-20 20.0cm
 BI 14-3534-22 22.0cm

LAMBERT-LOWMAN
 2x2 prongs
 BI 14-3535-18 18.0cm
 BI 14-3535-20 20.0cm
 BI 14-3535-22 22.0cm

LOWMAN-HOGLUND
 BI 14-3536-12 12.0cm
 BI 14-3536-17 17.5cm
 BI 14-3536-20 20.0cm
 BI 14-3536-22 22.0cm

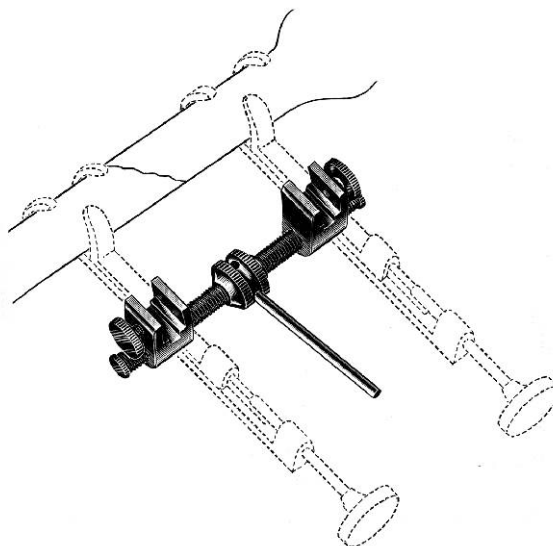

GERSTER
 BI 14-3537-15





13 cm/5 1/4"



BI 14-3538-01 BI 14-3538-02



13 cm/5 1/4"



BI 14-3539-01 BI 14-3539-02



KLEINERT-KUTZ
14 cm/5 1/2"

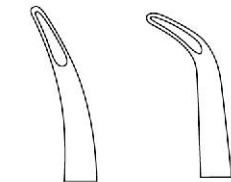

BI 14-3540-01 BI 14-3540-02

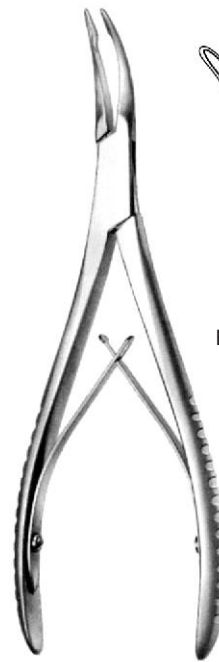

STELLBRINK
17 cm/6 3/4"

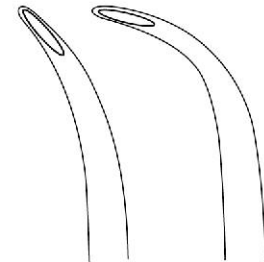

BI 14-3541-01 BI 14-3541-02



MINI-FRIEDMAN
 BI 14-3543-12
 12 cm/4 ¾"



FRIEDMAN
 BI 14-3544-14
 14 cm/5 ½"



MEAD
 BI 14-3545-16
 16.5 cm/6 ½"



MEAD
 BI 14-3546-16
 16.5 cm/6 ½"



HARTMANN
 BI 14-3547-16
 16 cm/6 ¼"



HARTMANN
 BI 14-3548-18
 18.5 cm/7 ¼"





JANSEN
18 cm/7"



BI 14-3552-01



BI 14-3552-02

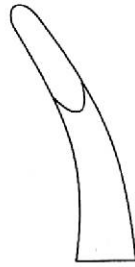

BI 14-3552-03

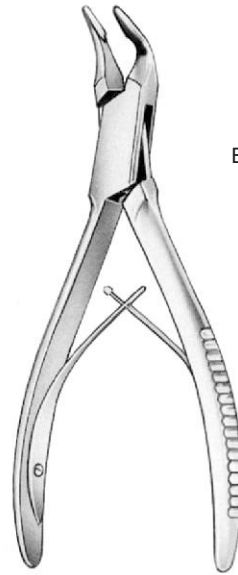

BLUMENTHAL
15 cm/6"



BI 14-3553-01



BI 14-3553-02



BI 14-3553-03



LEMPERT
20 cm/8"



BI 14-3554-20



BI 14-3555-20

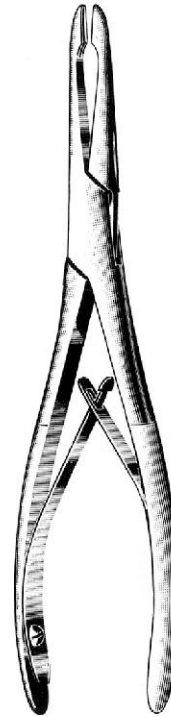

DEFOURMENTEL
BI 14-3556-19
19 cm/7 3/4"



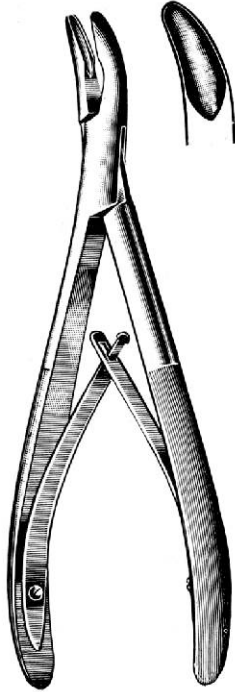

BANE
 BI 14-3557-18
 18 cm/7"

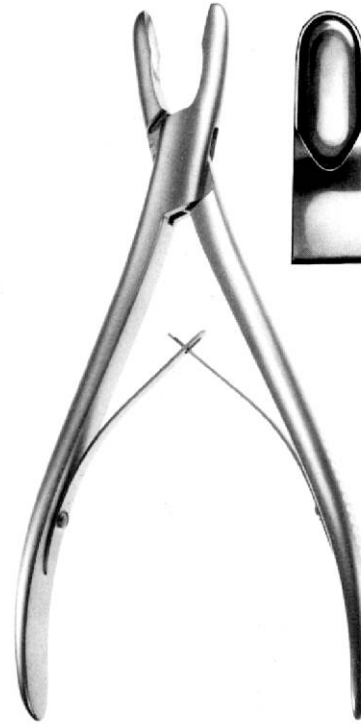

ADSON
 BI 14-3558-21
 21 cm/8 1/4"

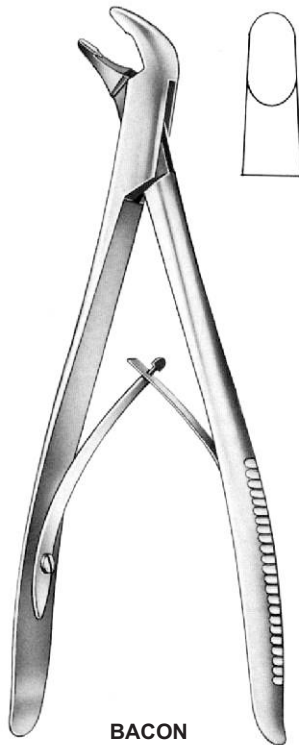

BACON
 BI 14-3559-20
 20 cm/8"



FISCH
 17 cm/6 3/4"



BI 14-3560-01



BI 14-3560-02





LUER
BI 14-3561-01
15 cm/6"



LUER
BI 14-3561-02
15 cm/6"

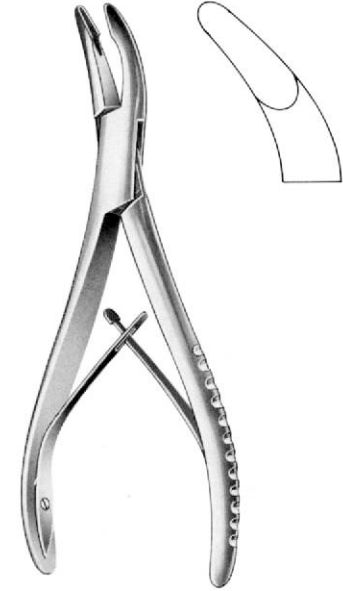

LUER
BI 14-3561-03
15 cm/6"



LUER
BI 14-3562-01
15 cm/6"



LUER
BI 14-3562-02
15 cm/6"

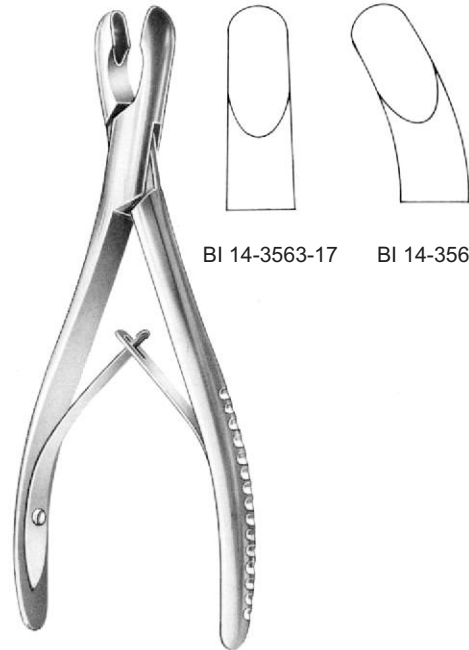

BI 14-3563-17

BI 14-3564-17

LUER
17 cm/6 3/4"

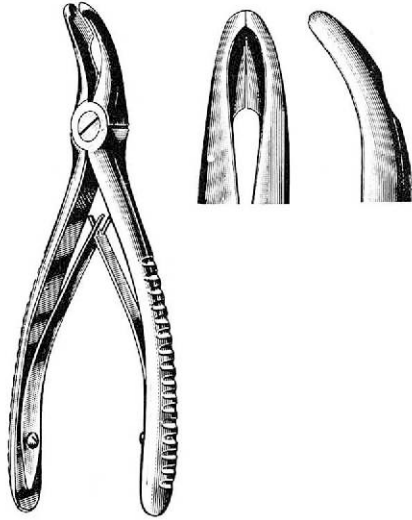

UNIVERSAL
 BI 14-3565-13
 13.5 cm/5 1/4"

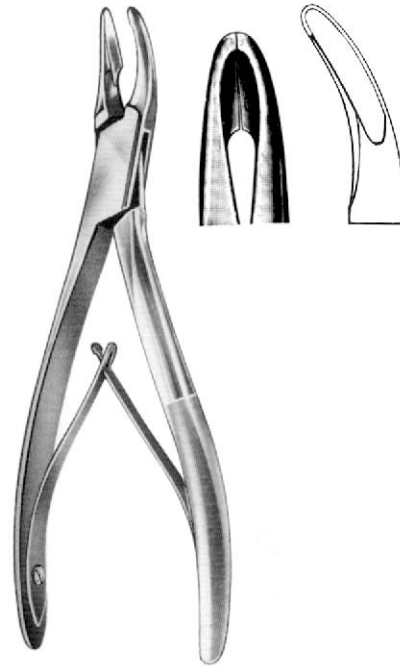

SCHELL
 BI 14-3566-17
 17 cm/6 3/4"

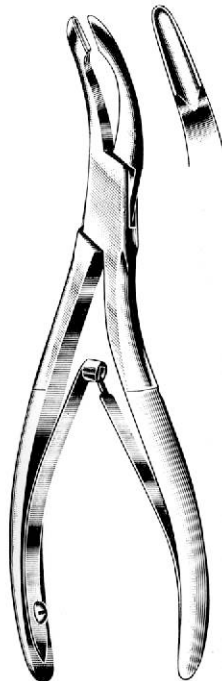

COTTLE-JANSEN
 BI 14-3567-18
 18 cm/7"

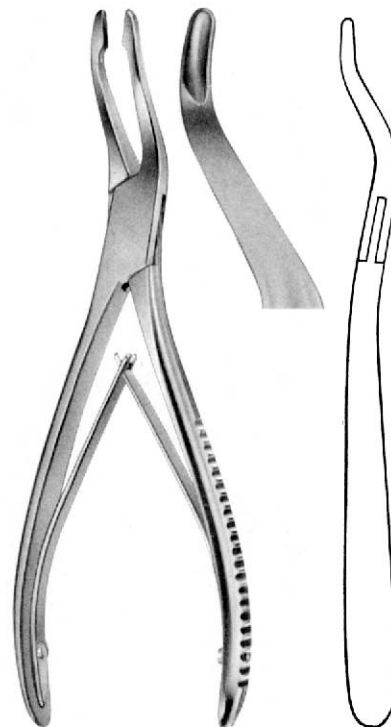

JANSEN
 BI 14-3568-19
 19 cm/7 1/2"





IDEAL
 BI 14-3636-00 handle only
 BI 14-3636-01 set



BI 14-3636-02



BI 14-3636-03



BI 14-3636-04



BI 14-3637-01 adult
 BI 14-3637-02 child