

**06**

- EN** TC Scissors
- DE** TC Scheren
- ES** Tijeras TC
- FR** Tijeras TC
- IT** Tijeras TC

**Page 75 to 84**

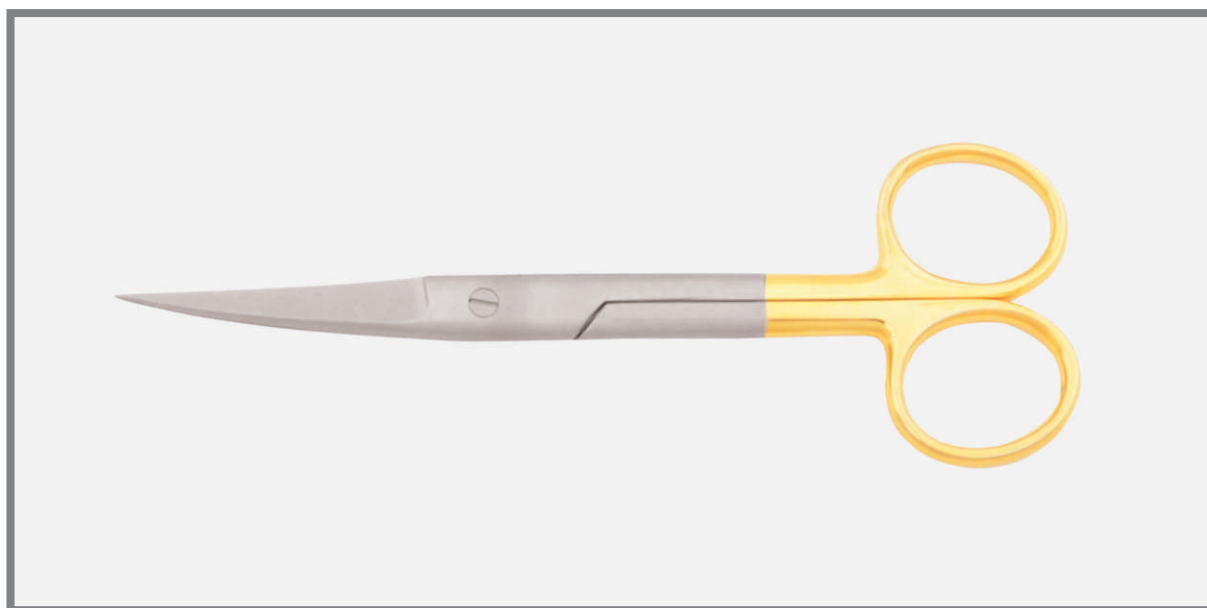

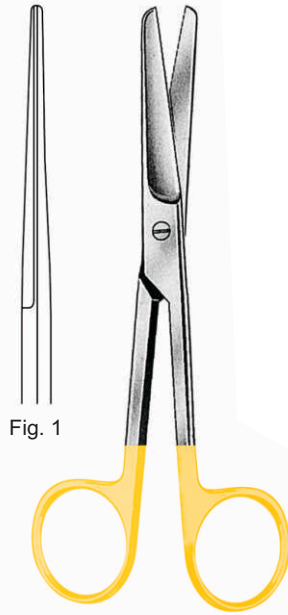

Fig. 1

**STANDARD**  
 BI 06-1801-14  
 14.5 cm/5 3/4"

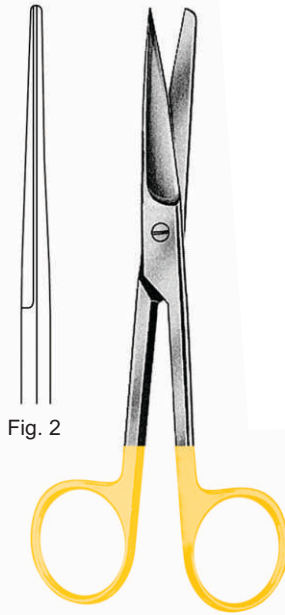

Fig. 2

**STANDARD**  
 BI 06-1802-14  
 14.5 cm/5 3/4"

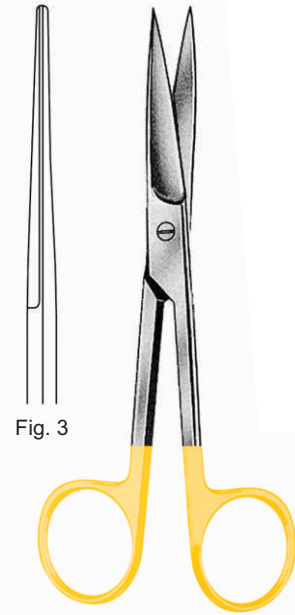

Fig. 3

**STANDARD**  
 BI 06-1803-14  
 14.5 cm/5 3/4"

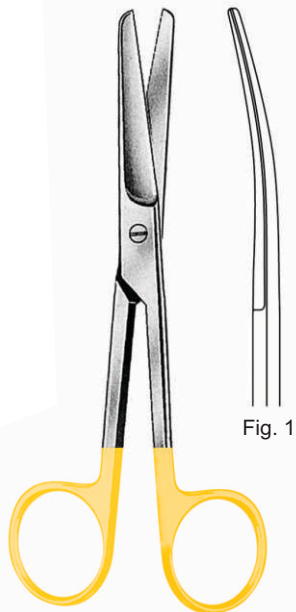

Fig. 1

**STANDARD**  
 BI 06-1804-14  
 14.5 cm/5 3/4"

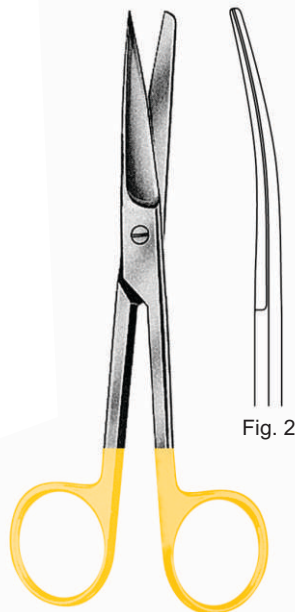

Fig. 2

**STANDARD**  
 BI 06-1805-14  
 14.5 cm/5 3/4"

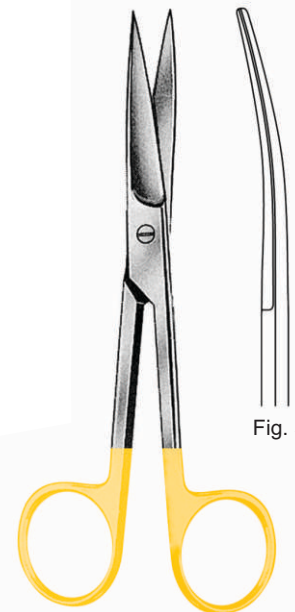
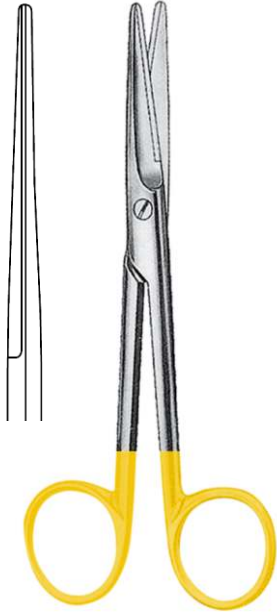

Fig. 3

**STANDARD**  
 BI 06-1806-14  
 14.5 cm/5 3/4"

TC Scissors



**MAYO-Straight**  
 BI 06-1807-14 14.5 cm/5 3/4"  
 BI 06-1807-17 17 cm/6 3/4"  
 BI 06-1807-23 23 cm/9"



**MAYO-Curved**  
 BI 06-1808-14 14.5 cm/5 3/4"  
 BI 06-1808-17 17 cm/6 3/4"  
 BI 06-1808-23 23 cm/9"



BI 06-1809-16 BI 06-1810-16  
 1/2  
**MAYO-LEXER**  
 Dissecting  
 16 cm/6 1/4"

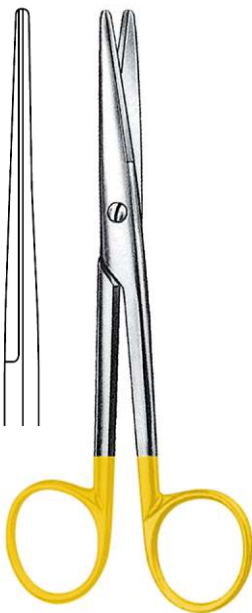

**MAYO-STILLE**  
 BI 06-1811-14 14.5 cm/5 3/4"  
 BI 06-1811-17 17 cm/6 3/4"

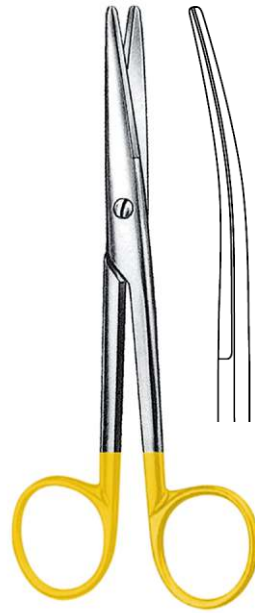

**MAYO-STILLE**  
 BI 06-1812-14 14.5 cm/5 3/4"  
 BI 06-1812-17 17 cm/6 3/4"

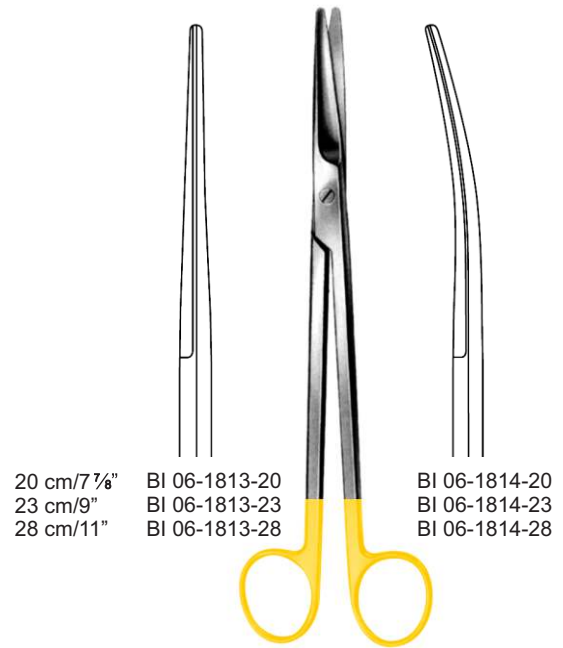

20 cm/7 7/8"  
 23 cm/9"  
 28 cm/11"  
 BI 06-1813-20  
 BI 06-1813-23  
 BI 06-1813-28  
 BI 06-1814-20  
 BI 06-1814-23  
 BI 06-1814-28  
**MAYO-HARRINGTON**  
 Gynecological



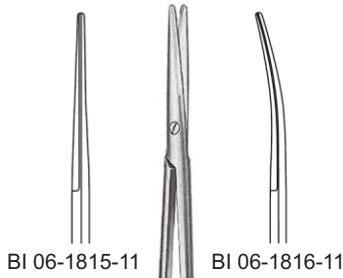

BI 06-1815-11 BI 06-1816-11



1/2

**METZENBAUM**  
11.5 cm/4 1/2"

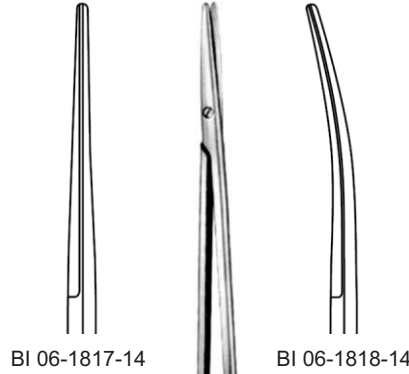

BI 06-1817-14 BI 06-1818-14



1/2

**METZENBAUM**  
14.5 cm/5 3/4"

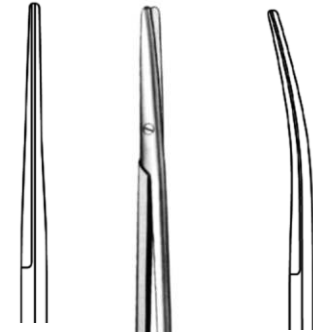

**METZENBAUM**

	Straight		Curved
BI 06-1819-18	18 cm/7 1/8"	BI 06-1820-18	BI 06-1820-18
BI 06-1819-20	20 cm/7 7/8"	BI 06-1820-20	BI 06-1820-20
BI 06-1819-23	23 cm/9"	BI 06-1820-23	BI 06-1820-23
BI 06-1819-25	25 cm/9 7/8"	BI 06-1820-25	BI 06-1820-25
BI 06-1819-28	28 cm/11"	BI 06-1820-28	BI 06-1820-28
BI 06-1819-30	30 cm/11 3/4"	BI 06-1820-30	BI 06-1820-30



1/2

**METZENBAUM-Fino**  
BI 06-1821-14  
14.5 cm/5 3/4"



1/2

**METZENBAUM-Fino**  
BI 06-1822-14  
14.5 cm/5 3/4"

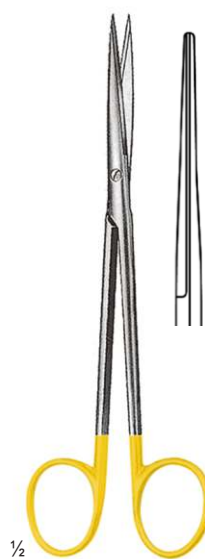

1/2

**METZENBAUM-Fino**  
BI 06-1823-14  
14.5 cm/5 3/4"

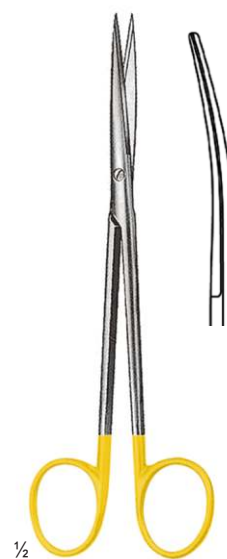

1/2

**METZENBAUM-Fino**  
BI 06-1824-14  
14.5 cm/5 3/4"

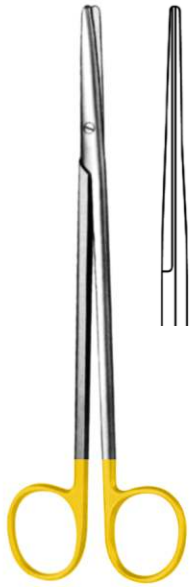

**METZENBAUM-Fino**  
 BI 06-1825-18 18 cm/7 1/8"  
 BI 06-1825-20 20 cm/7 7/8"  
 BI 06-1825-23 23 cm/9"  
 BI 06-1825-25 25 cm/9 7/8"  
 BI 06-1825-28 28 cm/11"

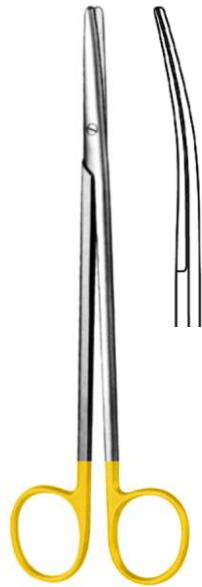

**METZENBAUM-Fino**  
 BI 06-1826-18 18 cm/7 1/8"  
 BI 06-1826-20 20 cm/7 7/8"  
 BI 06-1826-23 23 cm/9"  
 BI 06-1826-25 25 cm/9 7/8"  
 BI 06-1826-28 28 cm/11"

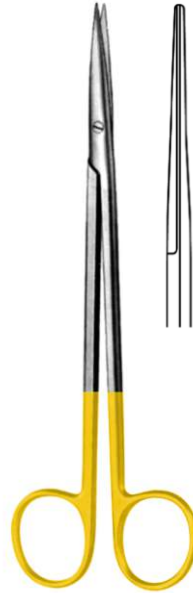

**METZENBAUM-Fino**  
 BI 06-1827-18 18 cm/7 1/8"  
 BI 06-1827-20 20 cm/7 7/8"  
 BI 06-1827-23 23 cm/9"  
 BI 06-1827-25 25 cm/9 7/8"  
 BI 06-1827-28 28 cm/11"

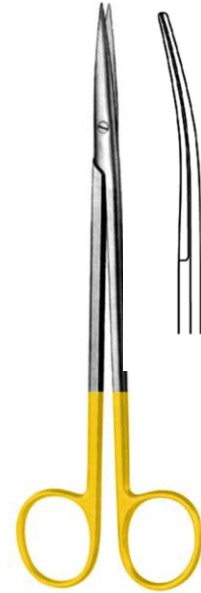

**METZENBAUM-Fino**  
 BI 06-1828-18 18 cm/7 1/8"  
 BI 06-1828-20 20 cm/7 7/8"  
 BI 06-1828-23 23 cm/9"  
 BI 06-1828-25 25 cm/9 7/8"  
 BI 06-1828-28 28 cm/11"

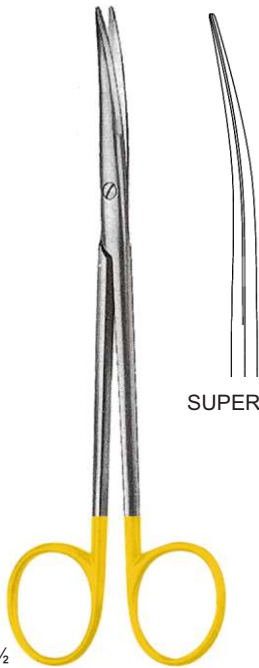

**TOENNIS-ADSON**  
 BI 06-1829-17  
 17.5 cm/6 7/8"

SUPER-Fino

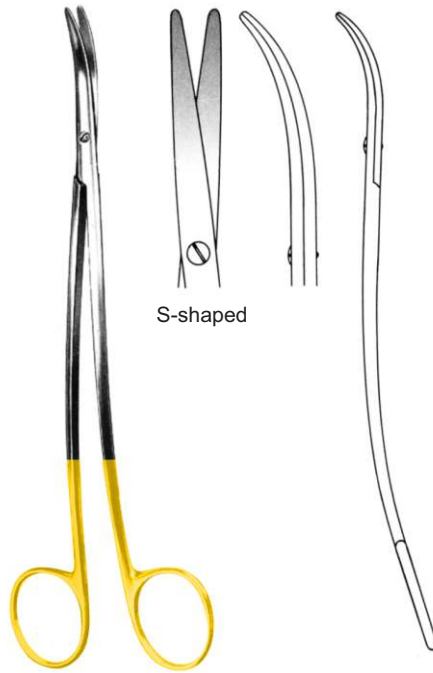

S-shaped

**METZENBAUM-Fino**  
 BI 06-1830-18 18 cm/7 1/8"  
 BI 06-1830-20 20 cm/7 7/8"  
 BI 06-1830-23 23 cm/9"

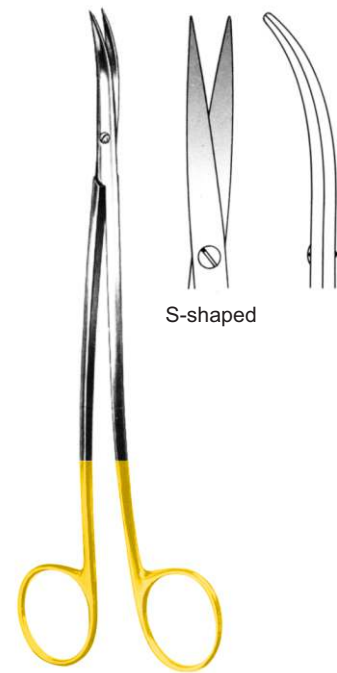

S-shaped

**METZENBAUM-Fino**  
 BI 06-1831-18 18 cm/7 1/8"  
 BI 06-1831-20 20 cm/7 7/8"  
 BI 06-1831-23 23 cm/9"



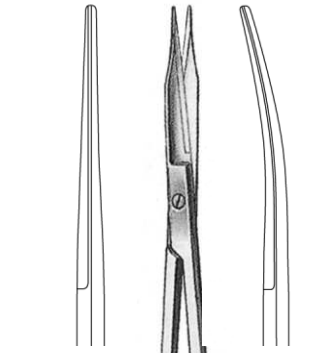

BI 06-1832-13

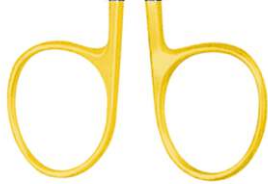

**GOLDMAN-FOX**  
13 cm/5 1/8"

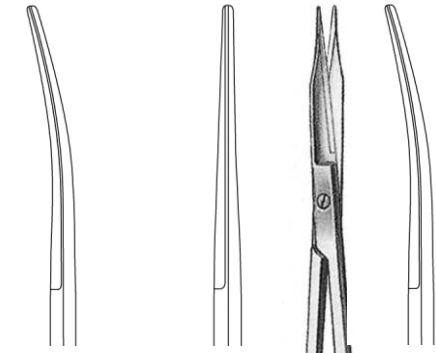

BI 06-1833-13

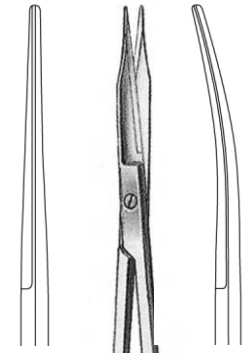

BI 06-1834-13

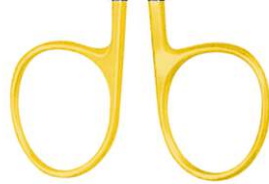

**GOLDMAN-FOX**  
Toothed blades  
13 cm/5 1/8"



BI 06-1836-10



**KNAPP/LEXER-Baby**  
StarbiBlus  
10 cm/3 1/8"



BI 06-1837-10

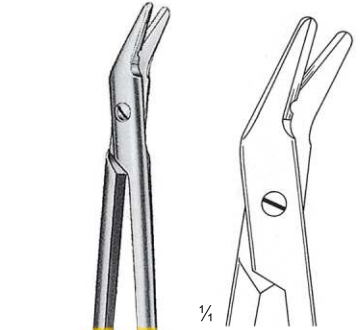

**UNIVERSAL (Wire Cutting)**  
BI 06-1838-12  
12 cm/4 3/4"



BI 06-1839-11



**IRIS**  
11.5 cm/4 1/2"

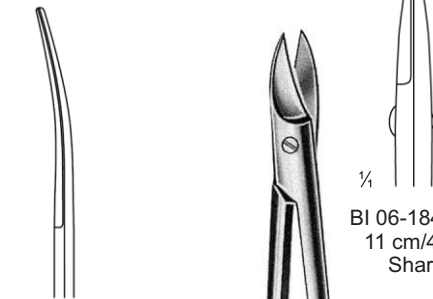

BI 06-1840-11



**BEEBEE**

BI 06-1841-11  
11 cm/4 1/2"  
Sharp



BI 06-1842-11  
11 cm/4 1/2"  
Sharp



BI 06-1843-10  
10 cm/3 1/8"  
Blunt



BI 06-1844-10  
10 cm/3 1/8"  
Blunt



BI 06-1845-11  
11 cm/4 3/8"  
Sharp



BI 06-1846-11  
11 cm/4 3/8"  
1 Blade serrated

TC Scissors



**KELLY**  
 BI 06-1847-16 16 cm/6 ¼"  
 BI 06-1847-18 18 cm/7 ⅛"

**KELLY**  
 BI 06-1848-16 16 cm/6 ¼"  
 BI 06-1848-18 18 cm/7 ⅛"

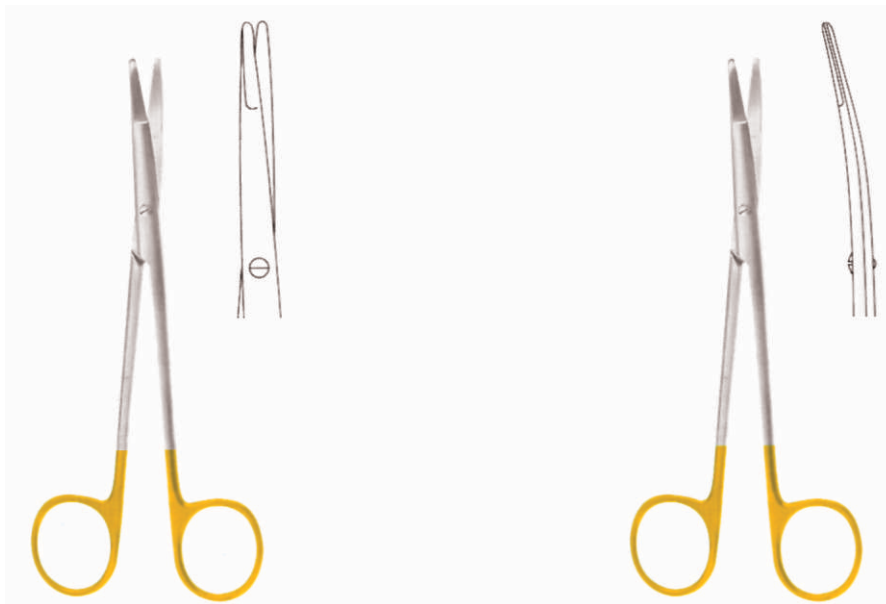

**RAGNELL**  
 BI 06-1849-12  
 12 cm/4 ¾"

**RAGNELL**  
 BI 06-1850-12  
 12 cm/4 ¾"





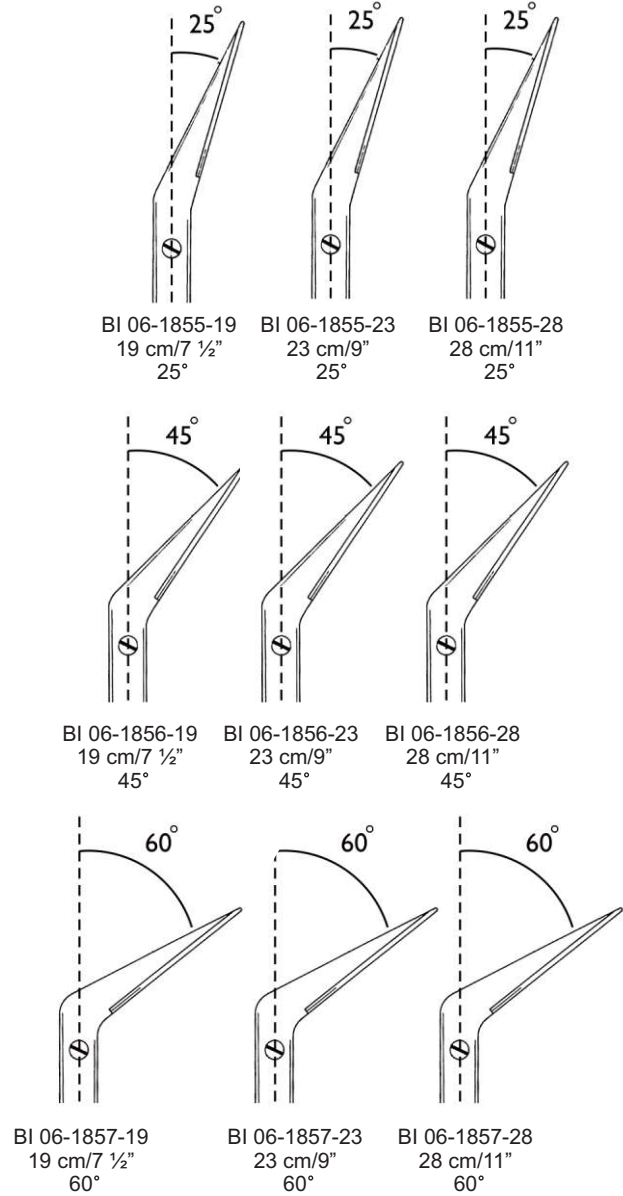
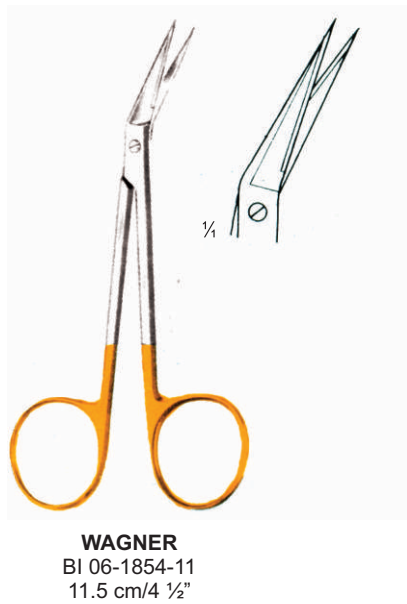
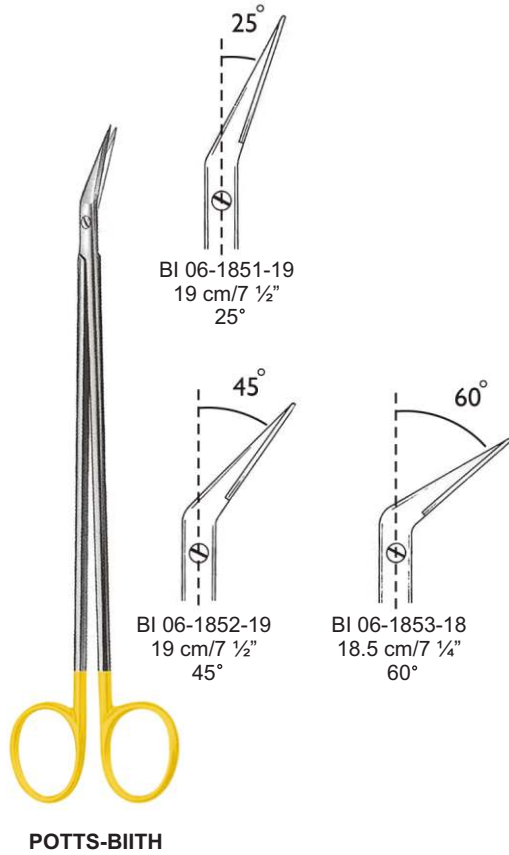



TC Scissors

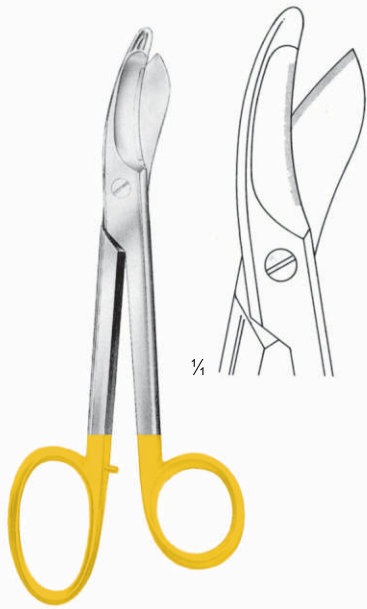

**BRUNS-Plaster**  
 BI 06-1858-24  
 24 cm/9 1/2"

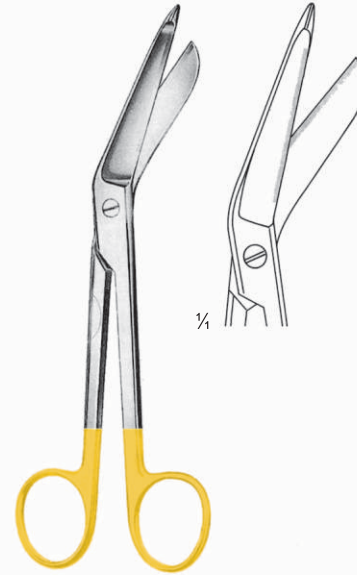

**LISTER-Bandage**  
 BI 06-1859-18  
 18 cm/7 1/8"

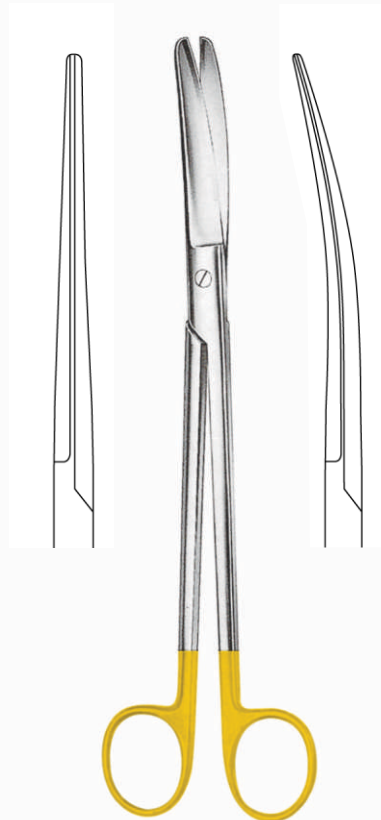

**SIMS (Uterine)**  
 BI 06-1860-20 20 cm/7 7/8" BI 06-1861-20  
 BI 06-1860-23 23 cm/9" BI 06-1861-23





BI 06-1862-16  
16 cm/6 1/4"

BI 06-1863-16  
16 cm/6 1/4"

**TC Scissors**

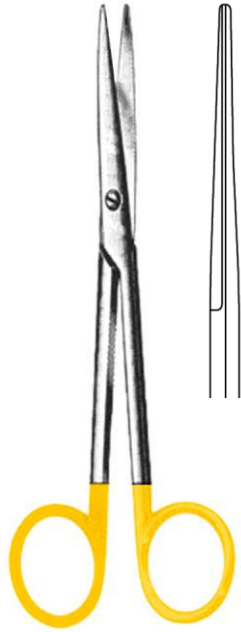

**LEXER**  
 BI 06-1864-16 16 cm/6 ¼"  
 BI 06-1864-21 21 cm/8 ¼"

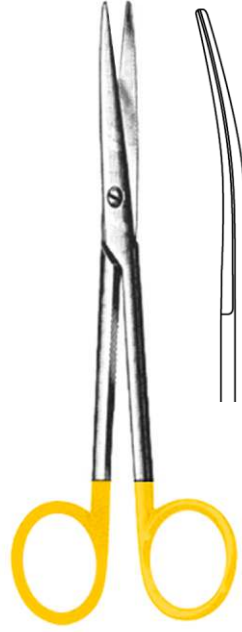

**LEXER**  
 BI 06-1865-16 16 cm/6 ¼"  
 BI 06-1865-21 21 cm/8 ¼"



**PARAMETRIUM**  
 BI 06-1866-22 22.5 cm/8 ¾"  
 BI 06-1866-23 23 cm/9"

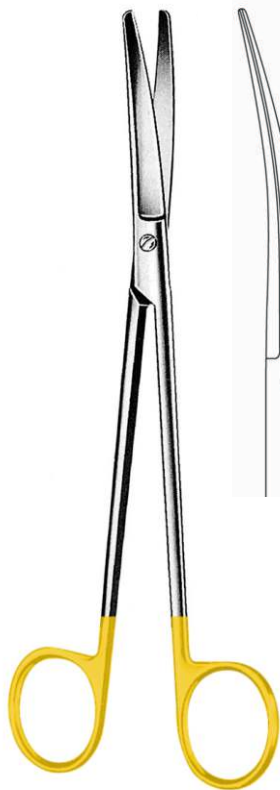

**WERTHEIM**  
 BI 06-1867-22  
 22.5 cm/8 ¾"

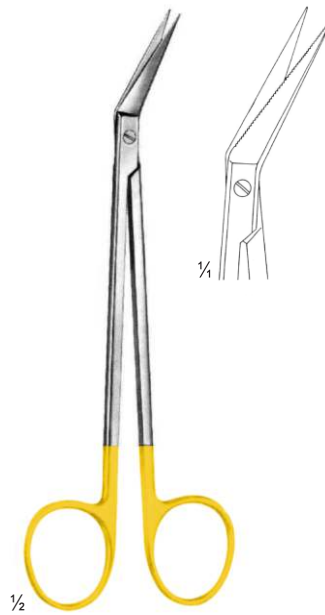

**LOCKLIN**  
 BI 06-1868-16  
 16 cm/6 ¼"  
 1 toothed blade



**LOCKLIN**  
 BI 06-1869-16  
 16 cm/6 ¼"  
 1 toothed blade

