

04

EN Scissors

DE Scheren

ES Tijeras

FR Tijeras

IT Tijeras

Page 38 to 64

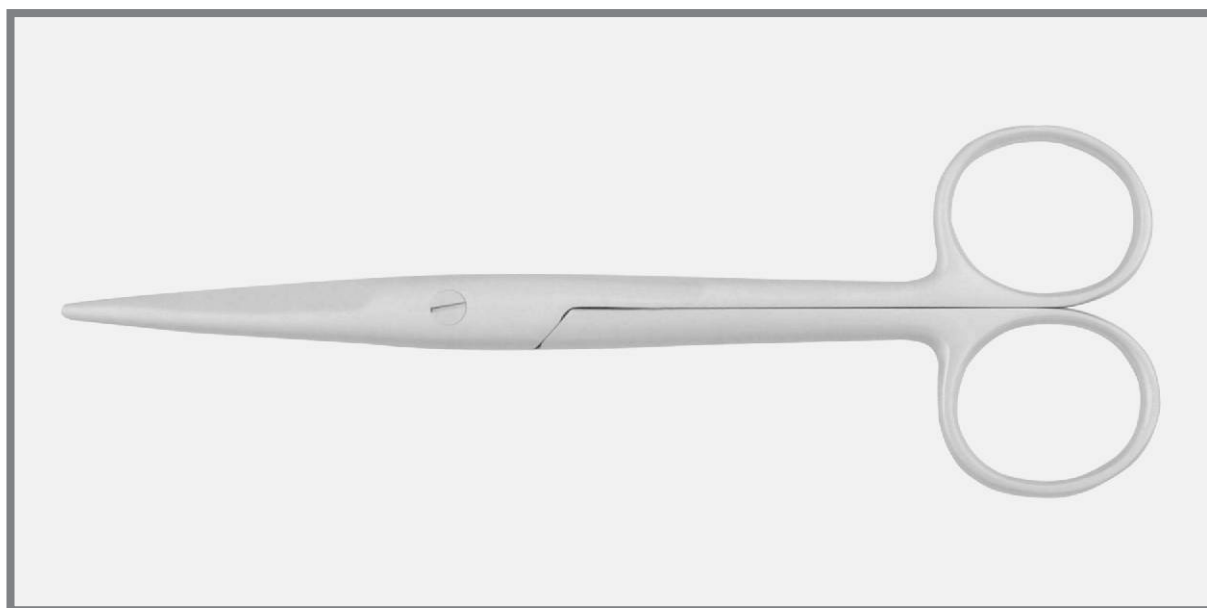

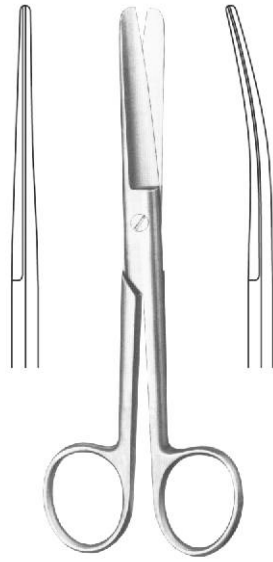

STANDARD
blunt/blunt

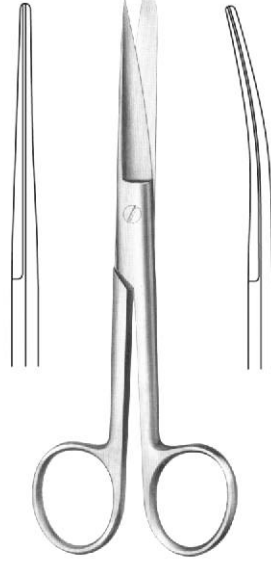

STANDARD
sharp/blunt

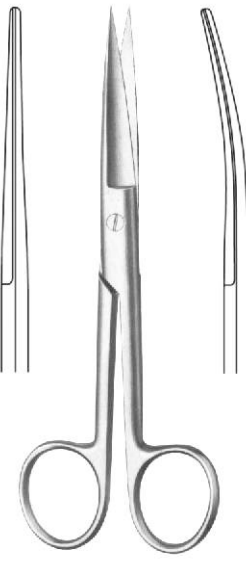

STANDARD
sharp/sharp

cm	in	Straight	Curved	Straight	Curved	Straight	Curved
10.5	4 1/8"	BI 04-1301-10	BI 04-1302-10	BI 04-1303-10	BI 04-1304-10	BI 04-1305-10	BI 04-1306-10
11.5	4 1/2"	BI 04-1301-11	BI 04-1302-11	BI 04-1303-11	BI 04-1304-11	BI 04-1305-11	BI 04-1306-11
13.0	5 1/8"	BI 04-1301-13	BI 04-1302-13	BI 04-1303-13	BI 04-1304-13	BI 04-1305-13	BI 04-1306-13
14.5	5 3/4"	BI 04-1301-14	BI 04-1302-14	BI 04-1303-14	BI 04-1304-14	BI 04-1305-14	BI 04-1306-14
15.5	6 1/8"	BI 04-1301-15	BI 04-1302-15	BI 04-1303-15	BI 04-1304-15	BI 04-1305-15	BI 04-1306-15
16.5	6 1/2"	BI 04-1301-16	BI 04-1302-16	BI 04-1303-16	BI 04-1304-16	BI 04-1305-16	BI 04-1306-16
17.5	6 7/8"	BI 04-1301-17	BI 04-1302-17	BI 04-1303-17	BI 04-1304-17	BI 04-1305-17	BI 04-1306-17
18.5	7 1/4"	BI 04-1301-18	BI 04-1302-18	BI 04-1303-18	BI 04-1304-18	BI 04-1305-18	BI 04-1306-18
20.0	7 7/8"	BI 04-1301-20	BI 04-1302-20	BI 04-1303-20	BI 04-1304-20	BI 04-1305-20	BI 04-1306-20

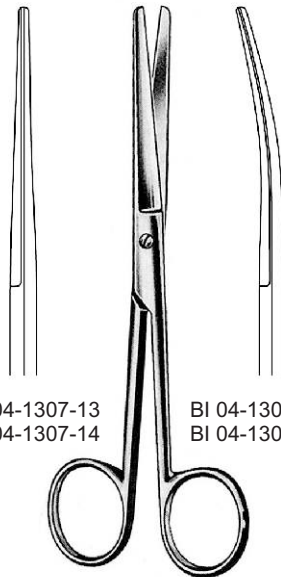

GRAZIL
blunt/blunt

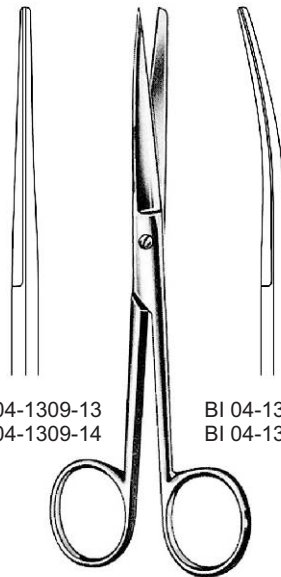

GRAZIL
sharp/blunt

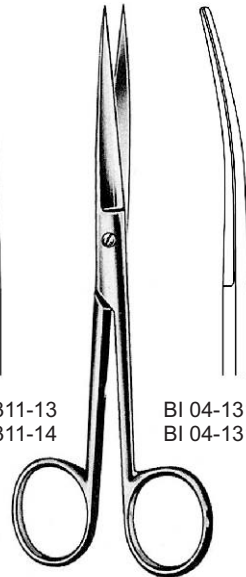

GRAZIL
sharp/sharp

cm	in	Straight	Curved	Straight	Curved	Straight	Curved
13.0	5 1/8"	BI 04-1307-13	BI 04-1308-13	BI 04-1309-13	BI 04-1310-13	BI 04-1311-13	BI 04-1312-13
14.5	5 3/4"	BI 04-1307-14	BI 04-1308-14	BI 04-1309-14	BI 04-1310-14	BI 04-1311-14	BI 04-1312-14

SCALPEL

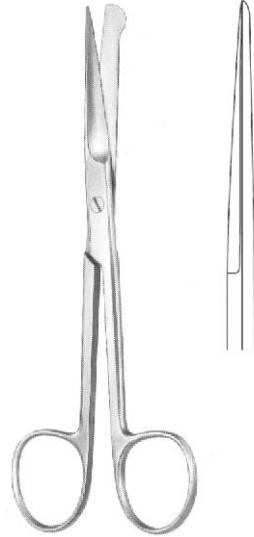

INCISION
 BI 04-1313-13 13 cm/5 1/8"
 BI 04-1313-14 14.5 cm/5 3/4"

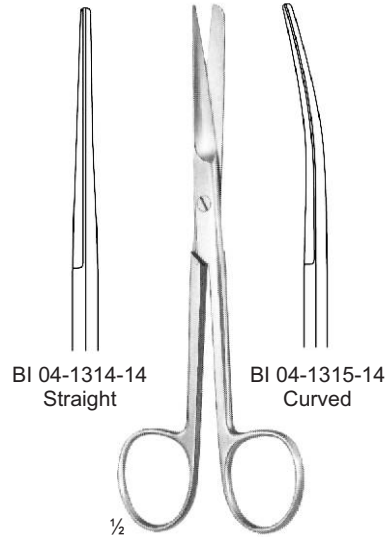

BI 04-1314-14 Straight
 BI 04-1315-14 Curved
 1/2
DEAVER
 14 cm/5 1/2"

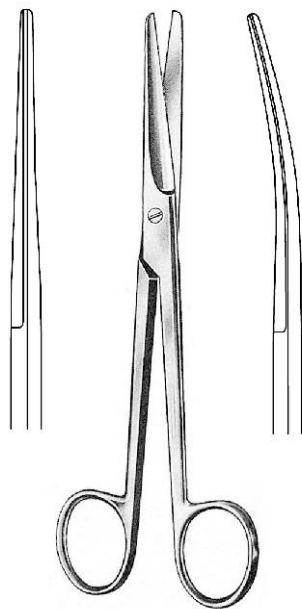

MAYO
 straight BI 04-1316-14 14.5 cm/5 3/4"
 BI 04-1316-15 15 cm/5 7/8"
 BI 04-1316-17 17 cm/6 3/4"
 BI 04-1316-23 23 cm/9"
 curved BI 04-1317-14
 BI 04-1317-15
 BI 04-1317-17
 BI 04-1317-23

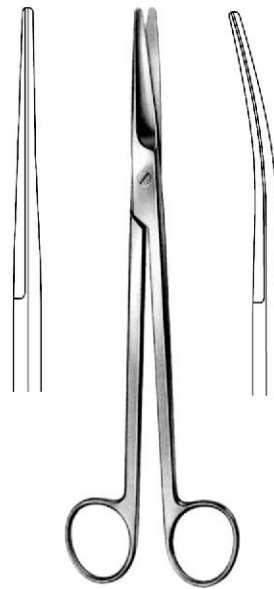

MAYO-HARRINGTON
 straight BI 04-1318-23 23 cm/9"
 BI 04-1318-28 28 cm/11"
 curved BI 04-1319-23
 BI 04-1319-28

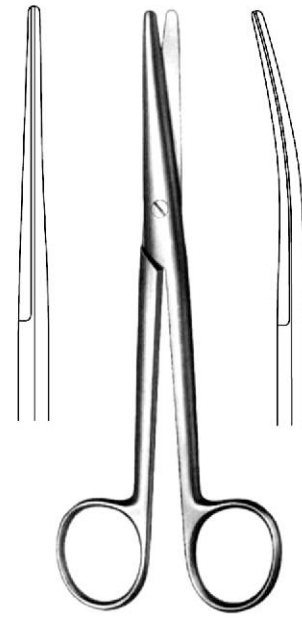

MAYO-STILLE
 straight BI 04-1320-15 15 cm/5 7/8"
 BI 04-1320-16 16.5 cm/6 1/2"
 BI 04-1320-17 17 cm/6 3/4"
 BI 04-1320-19 19.5 cm/7 1/2"
 BI 04-1320-21 21 cm/8 1/4"
 curved BI 04-1321-15
 BI 04-1321-16
 BI 04-1321-17
 BI 04-1321-19
 BI 04-1321-21





MAYO-NOBLE
16.5 cm/6 1/2"



BI 04-1322-16
straight

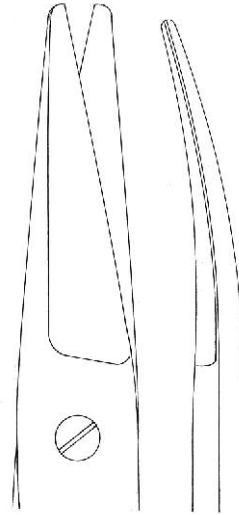

BI 04-1323-16
curved



WERTHEIM

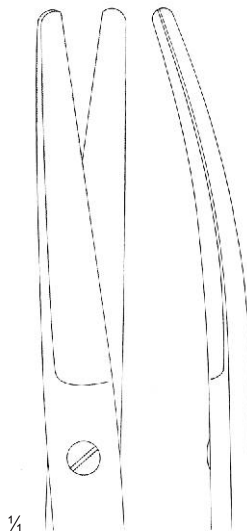

BI 04-1324-20
20 cm/7 7/8"

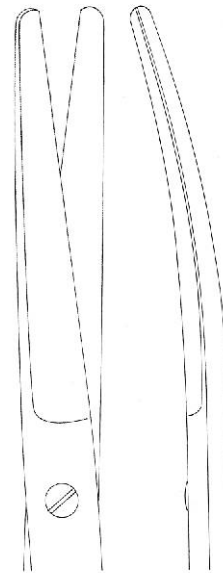

BI 04-1324-23
23 cm/9"

Scissors

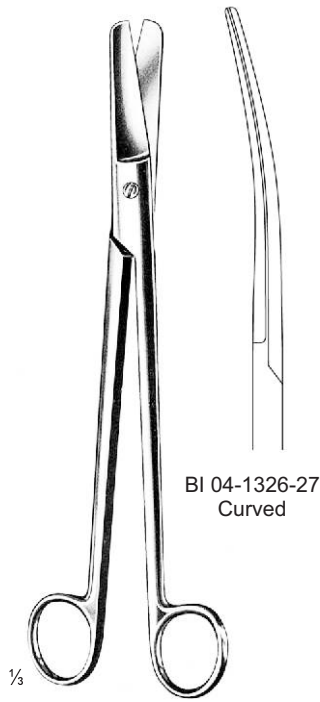

DUBOIS
 BI 04-1325-27
 27 cm/10 1/2"
 Straight

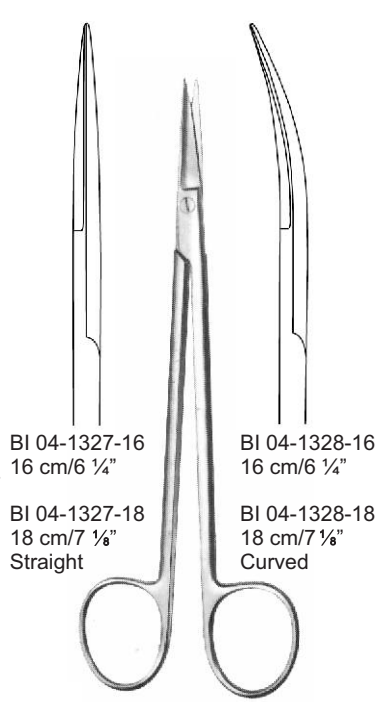

KELLY

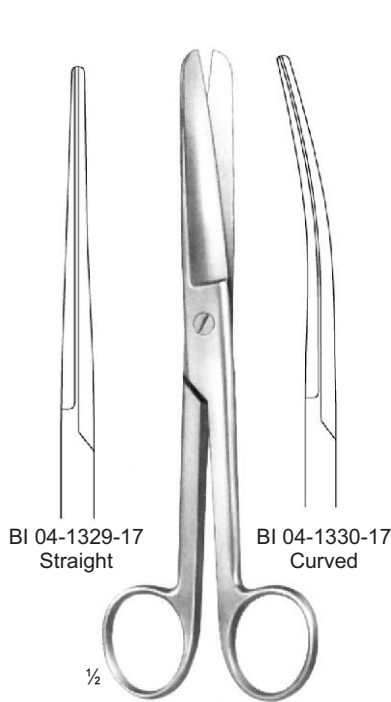

DOYEN
 17.5 cm/6 7/8"

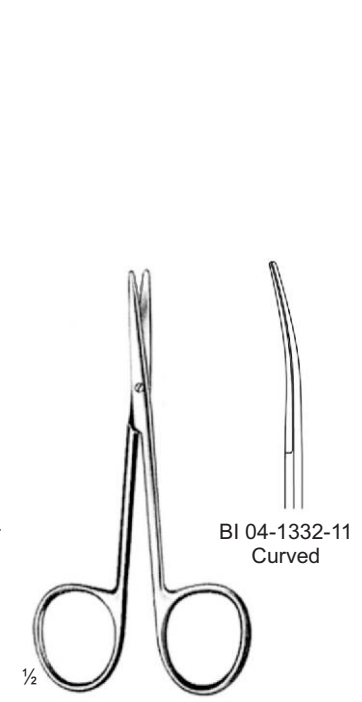

METZENBAUM BABY
 BI 04-1331-11
 11.5 cm/4 1/2"
 Straight

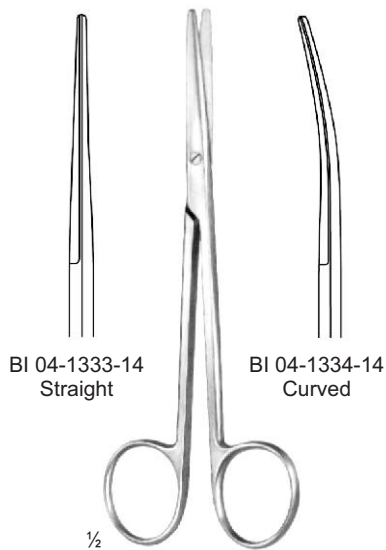

METZENBAUM
 14.5 cm/5 3/4"
 blunt/blunt

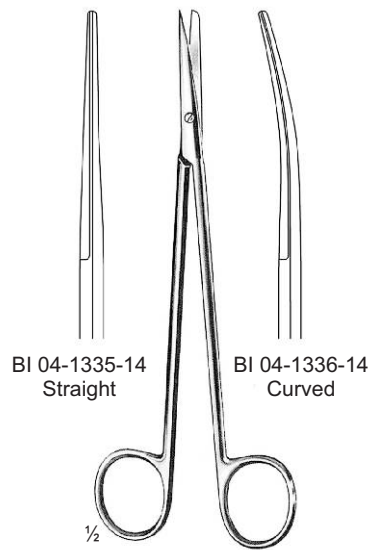

METZENBAUM
 14.5 cm/5 3/4"
 sharp/blunt

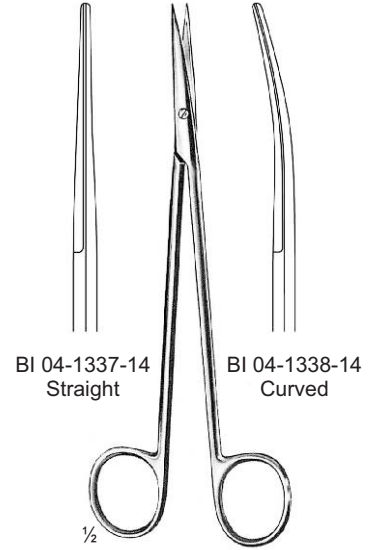

METZENBAUM
 14.5 cm/5 3/4"
 sharp/sharp



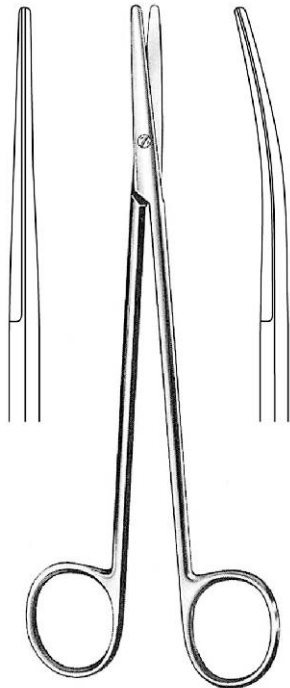

METZENBAUM-NELSON
blunt/blunt

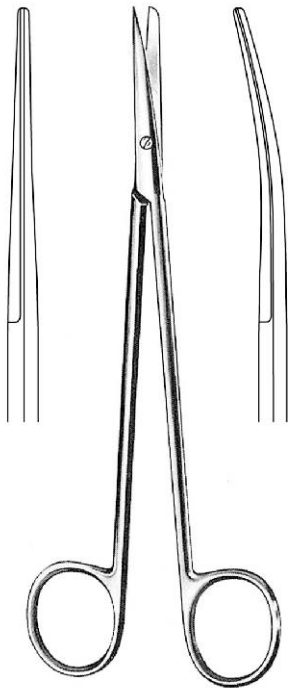

METZENBAUM-NELSON
sharp/blunt

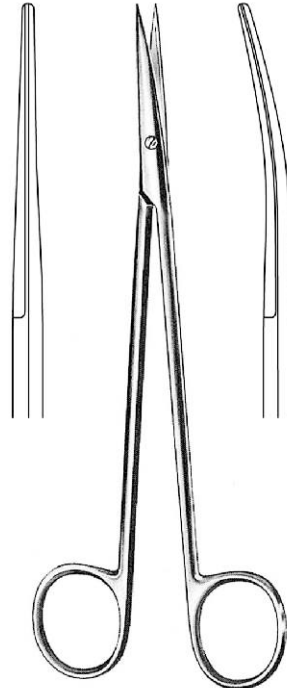

METZENBAUM-NELSON
sharp/sharp

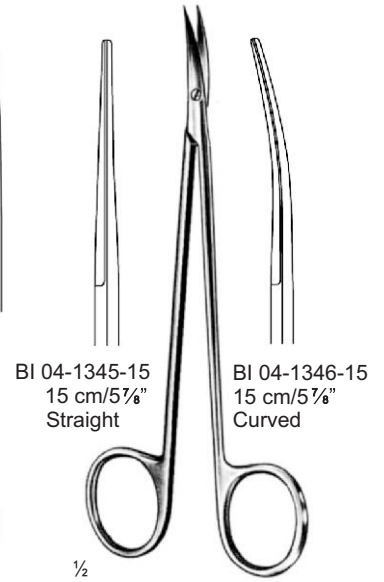

BI 04-1345-15
15 cm/5 7/8"
Straight

BI 04-1346-15
15 cm/5 7/8"
Curved

1/2

NERVE DISSECTING SCISSORS

cm	in	straight	curved	straight	curved	straight	curved
18	7 1/8"	BI 04-1339-18	BI 04-1340-18	BI 04-1341-18	BI 04-1342-18	BI 04-1343-18	BI 04-1344-18
20	7 7/8"	BI 04-1339-20	BI 04-1340-20	BI 04-1341-20	BI 04-1342-20	BI 04-1343-20	BI 04-1344-20
23	9"	BI 04-1339-23	BI 04-1340-23	BI 04-1341-23	BI 04-1342-23	BI 04-1343-23	BI 04-1344-23
25	9 7/8"	BI 04-1339-25	BI 04-1340-25	BI 04-1341-25	BI 04-1342-25	BI 04-1343-25	BI 04-1344-25
28	11"	BI 04-1339-28	BI 04-1340-28	BI 04-1341-28	BI 04-1342-28	BI 04-1343-28	BI 04-1344-28
30	11 3/4"	BI 04-1339-30	BI 04-1340-30	BI 04-1341-30	BI 04-1342-30	BI 04-1343-30	BI 04-1344-30

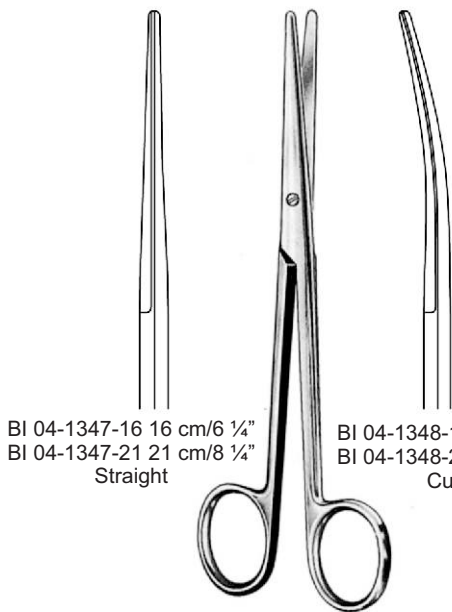

BI 04-1347-16 16 cm/6 1/4"
BI 04-1347-21 21 cm/8 1/4"
Straight

BI 04-1348-16 16 cm/6 1/4"
BI 04-1348-21 21 cm/8 1/4"
Curved

LEXER

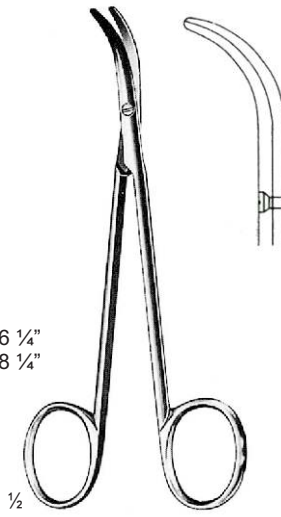

1/2

FOMON
BI 04-1349-13
13.5 cm/5 3/8"

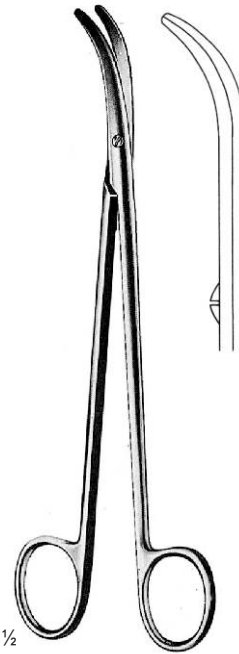

1/2

THOREK
BI 04-1350-19
19 cm/7 1/2"

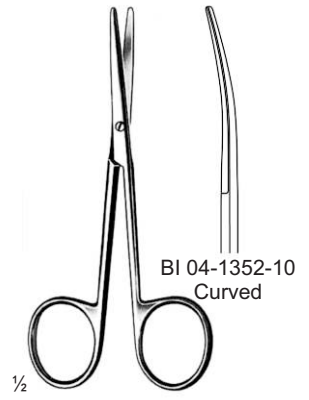

1/2

LEXER-BABY
BI 04-1351-10
10 cm/3 7/8"
Straight

BI 04-1352-10
Curved

Scissors

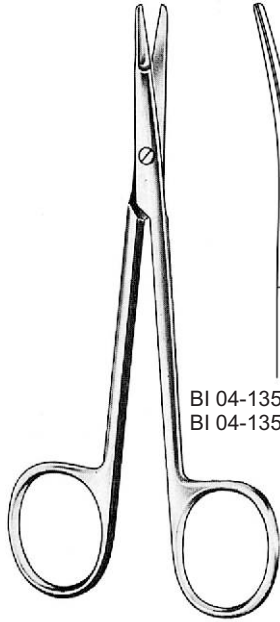

BI 04-1354-12 12 cm/4 3/4"
 BI 04-1354-15 15 cm/5 7/8"

KILNER
 BI 04-1353-13
 13 cm/5 1/8"

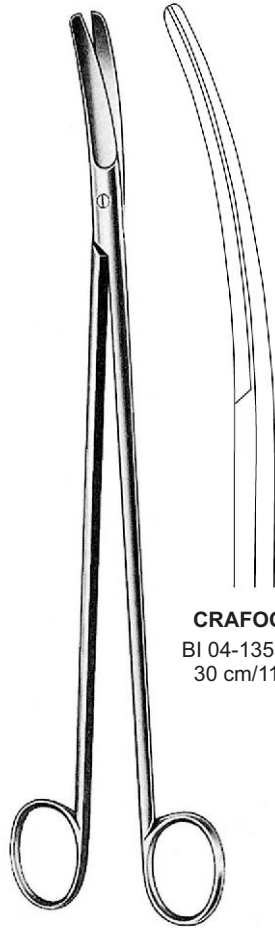

CRAFOORD
 BI 04-1355-30
 30 cm/11 3/4"

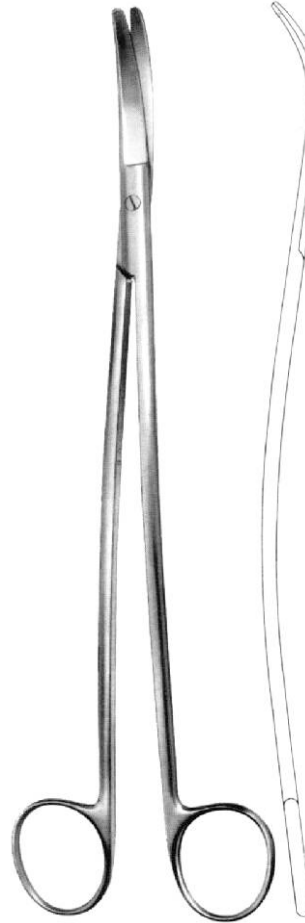

SATINSKY
 BI 04-1356-24
 24.5 cm/9 5/8"

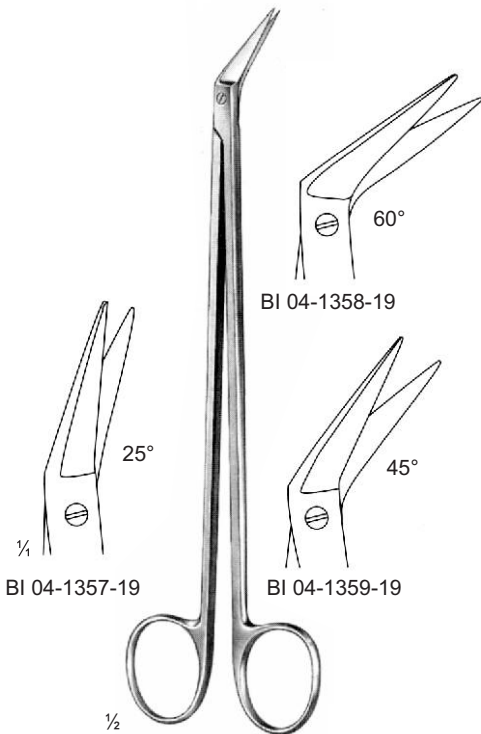

BI 04-1357-19

BI 04-1358-19

BI 04-1359-19

1/2

POTTS-BIITH
 19 cm/7 1/2"



DEBAKEY

16 cm/6 1/4" BI 04-1360-16
 23 cm/9" BI 04-1360-23
 28 cm/11" BI 04-1360-28

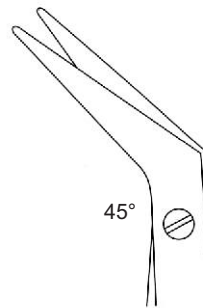

45°

BI 04-1361-16
 BI 04-1361-23
 BI 04-1361-28

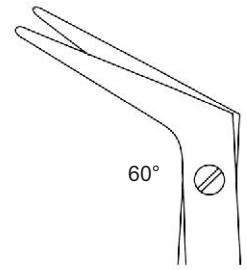

60°

BI 04-1362-16
 BI 04-1362-23
 BI 04-1362-28



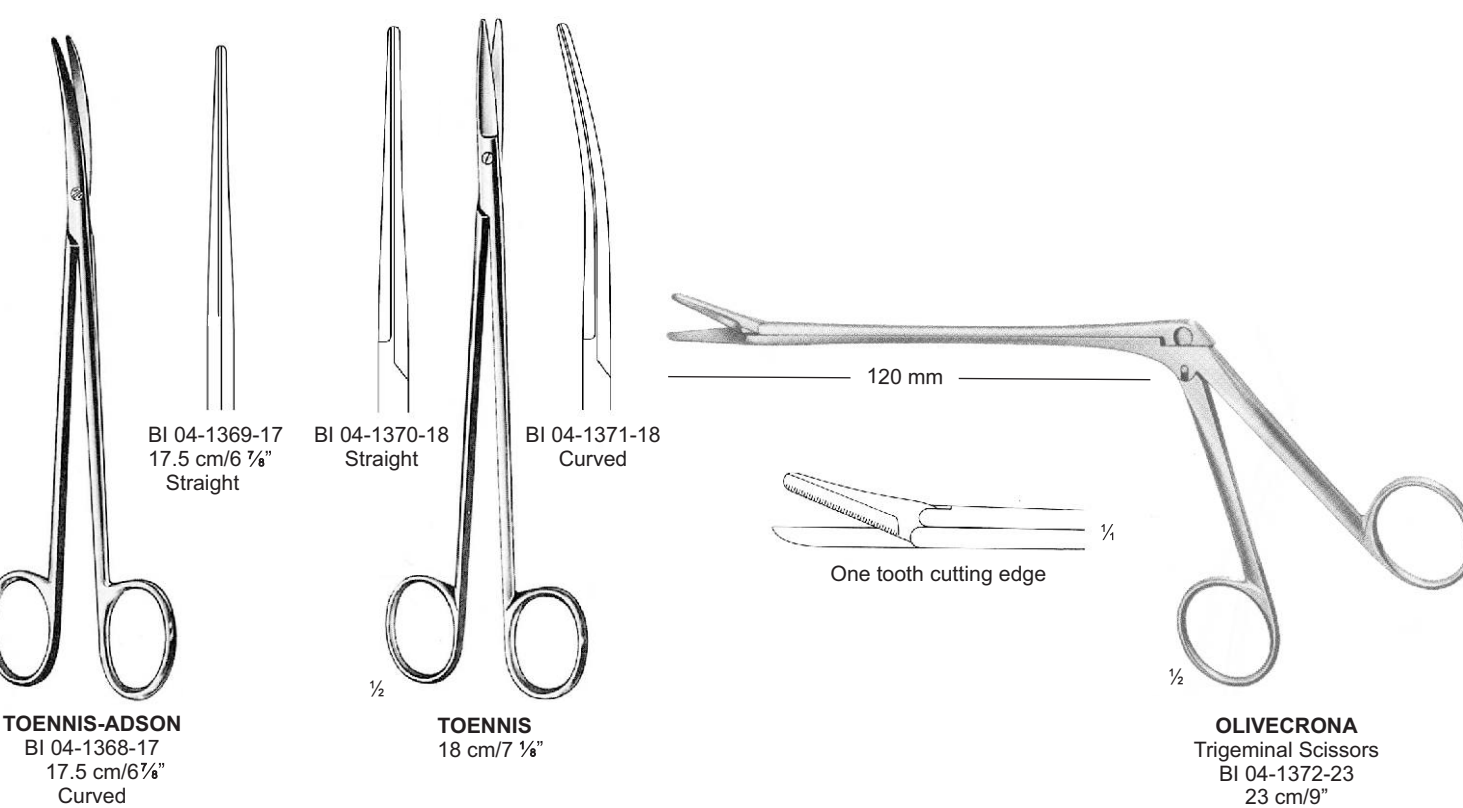
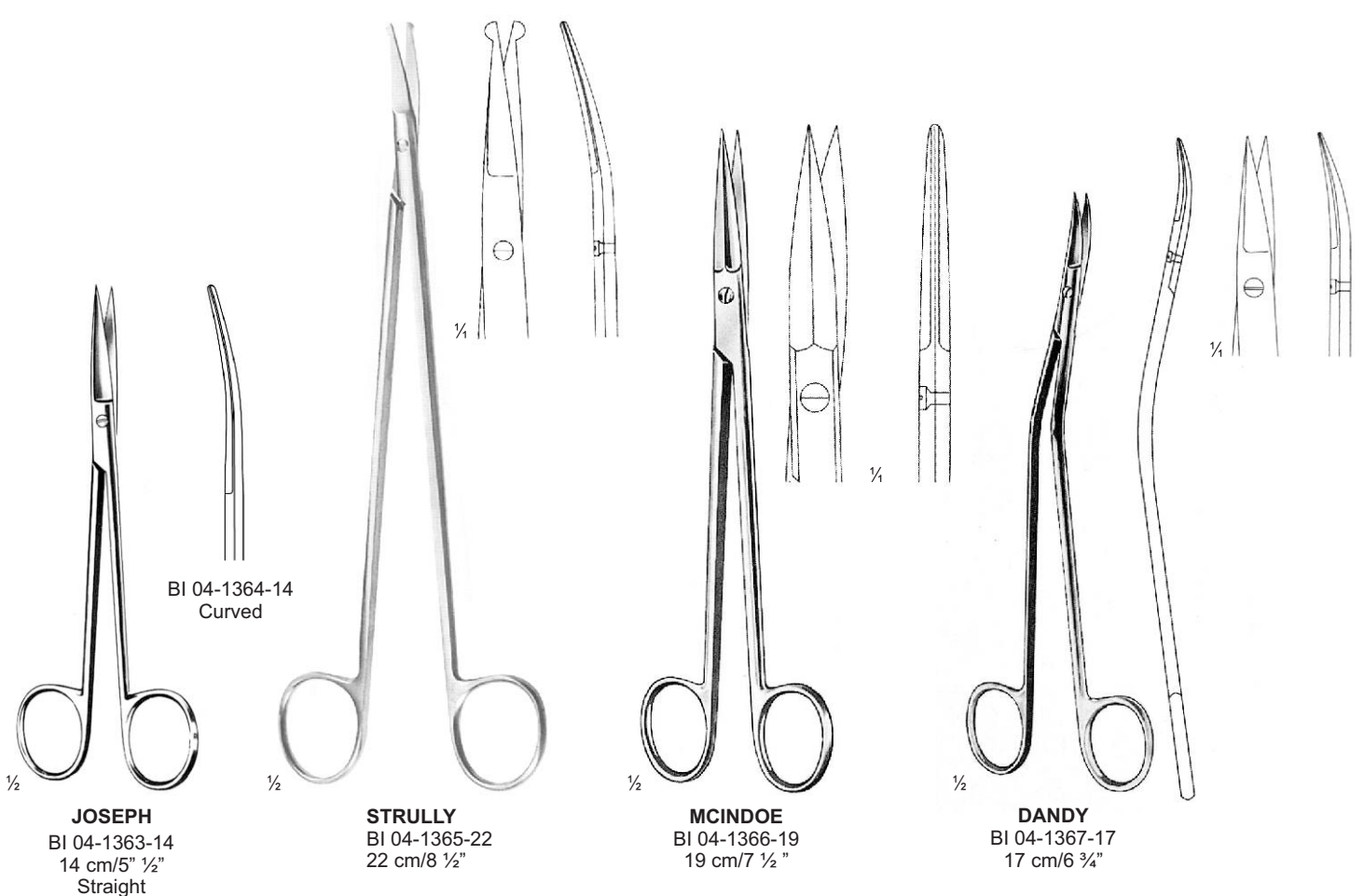

Scissors

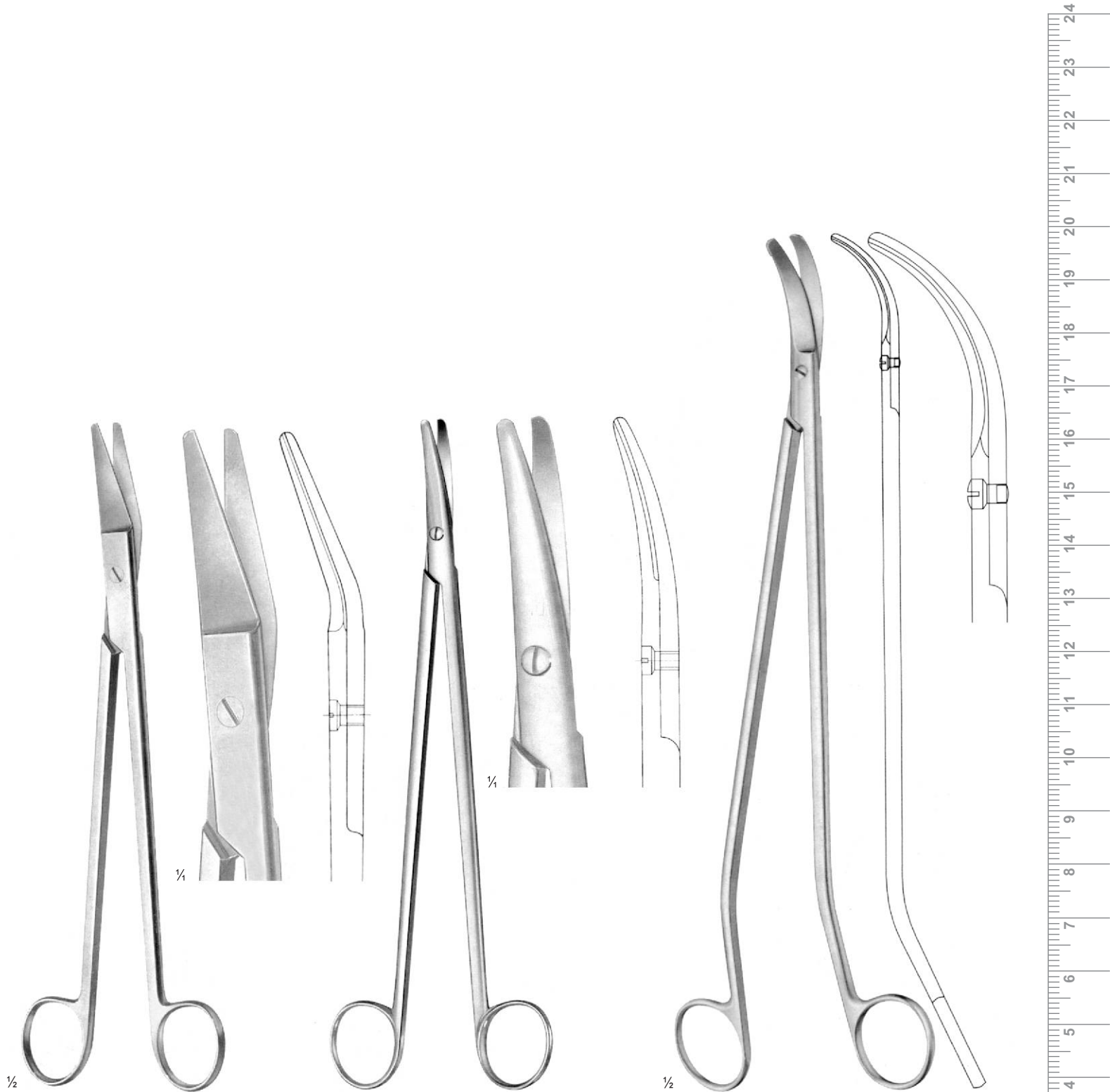

½
RESANO
 BI 04-1373-25
 25 cm/9 7/8"
 Cartilage scissors

¼
WELLER
 BI 04-1374-28
 28 cm/11"
 Dissecting scissors
 heavy pattern

½
MULLER
 BI 04-1375-32
 32.5 cm/12 3/4"

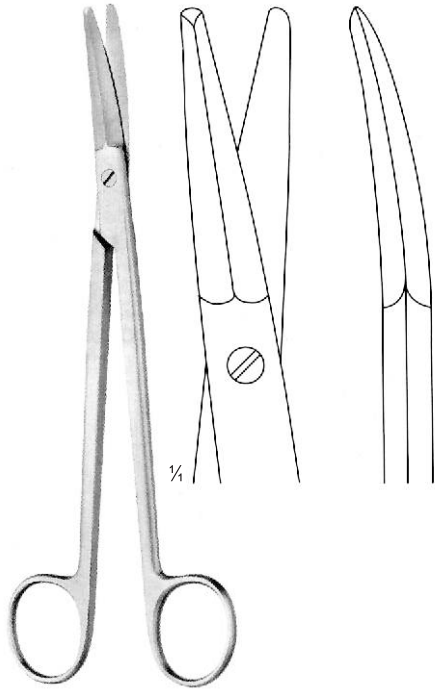

BOETTCHER
BI 04-1376-18
18 cm/7 1/8"

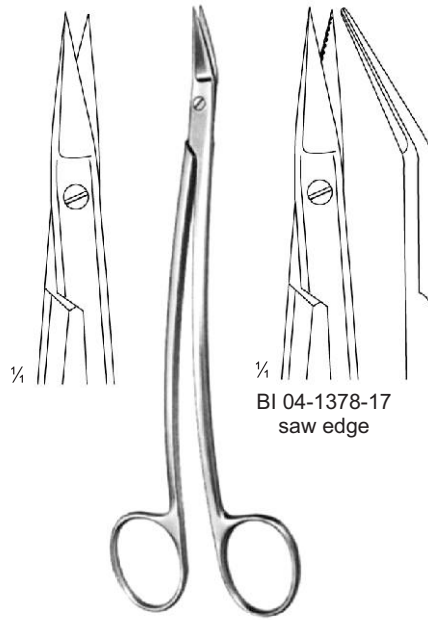

DEAN
BI 04-1377-17
17 cm/6 3/4"

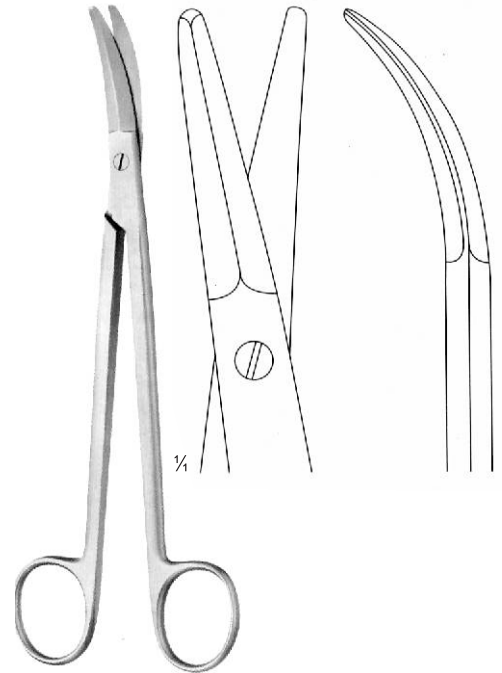

PRINCE
BI 04-1379-17
17.5 cm/6 7/8"

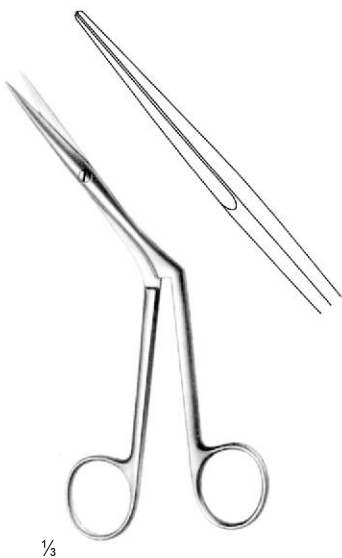

HEYMANN
BI 04-1380-18
18 cm/7 1/8"

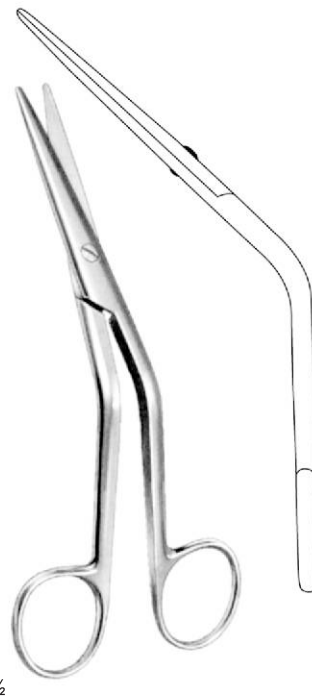

COTTLE
BI 04-1381-16
16 cm/6 1/4"

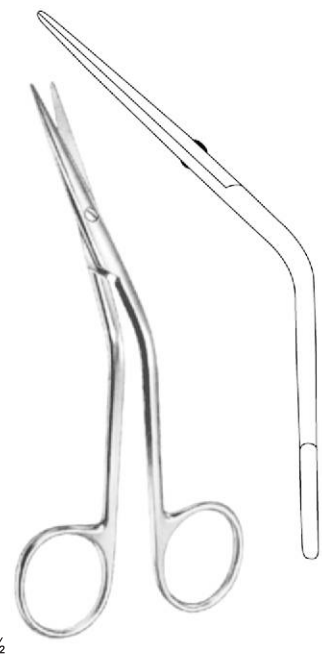

FOMON
BI 04-1382-15
15 cm/5 7/8"

Scissors

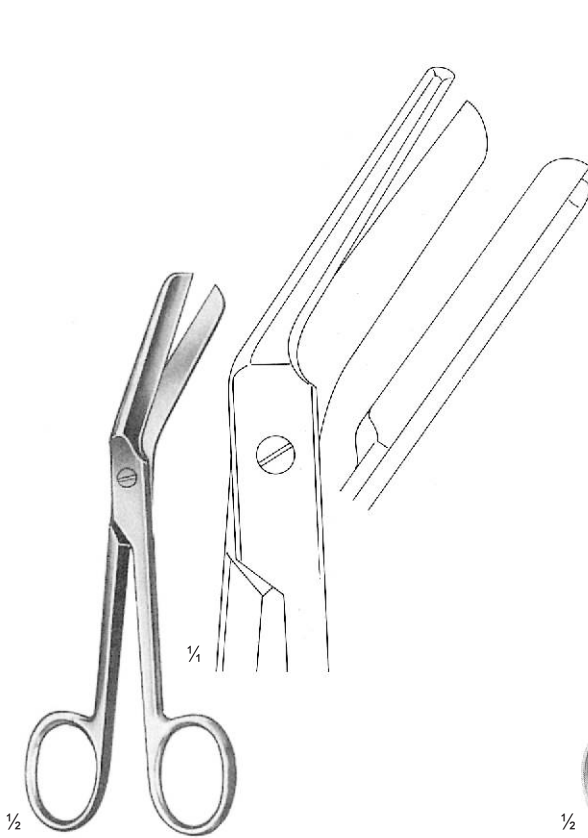

BRAUN-STADLER
 BI 04-1383-14
 14.5 cm/5 3/4"

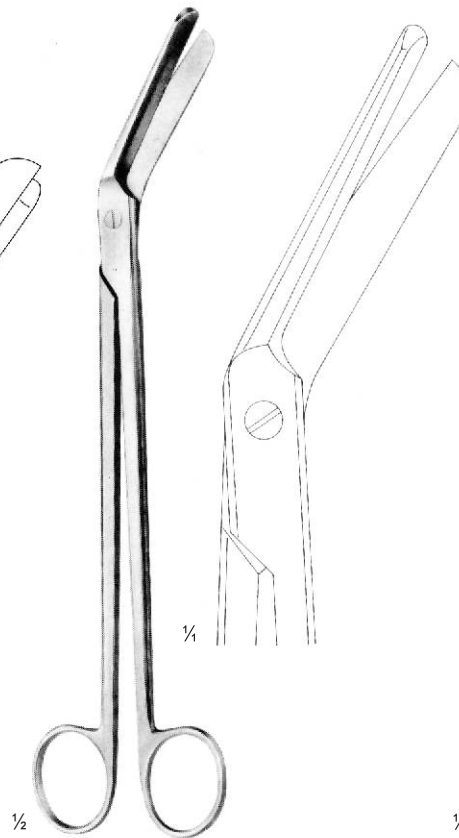

BRAUN-STADLER
 BI 04-1384-22
 22 cm/8 1/2"

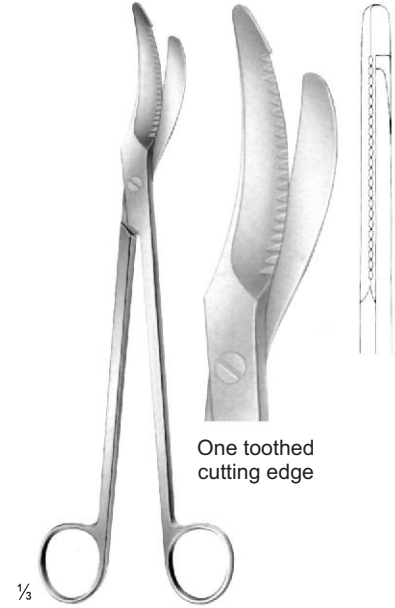

BI 04-1385-24
 Episiotomy Scissors
 24 cm/9 1/2"

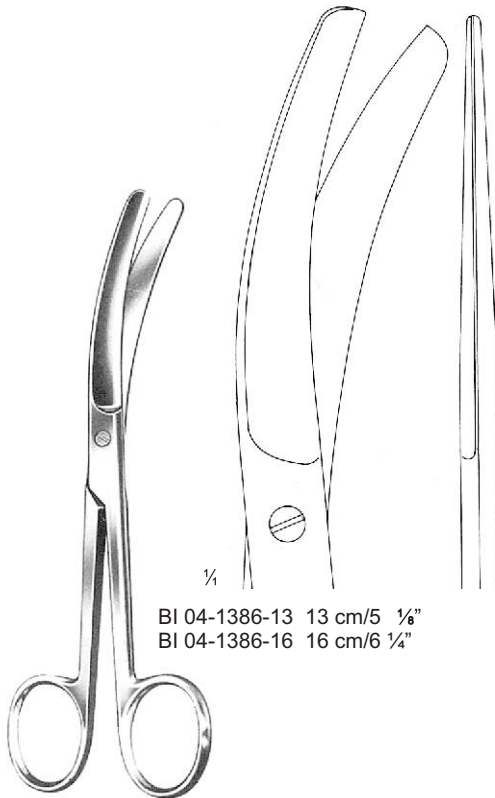

BI 04-1386-13 13 cm/5 1/8"
 BI 04-1386-16 16 cm/6 1/4"

BUSCH

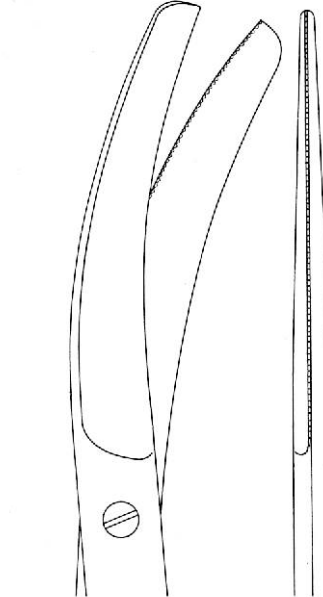

BI 04-1387-13 13 cm/5 1/8"
 BI 04-1387-16 16 cm/6 1/4"
 One tooth cutting edge

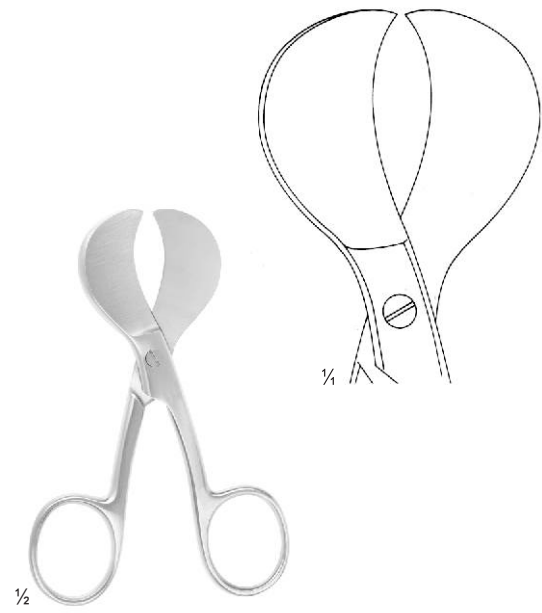

MOD. USA
 BI 04-1388-10
 10.5 cm/4 1/8"



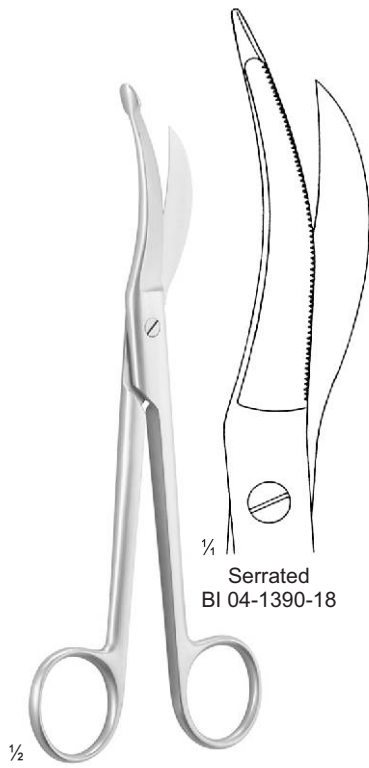

WALDMANN
BI 04-1389-18
18 cm/7 1/8"
Non-Serrated

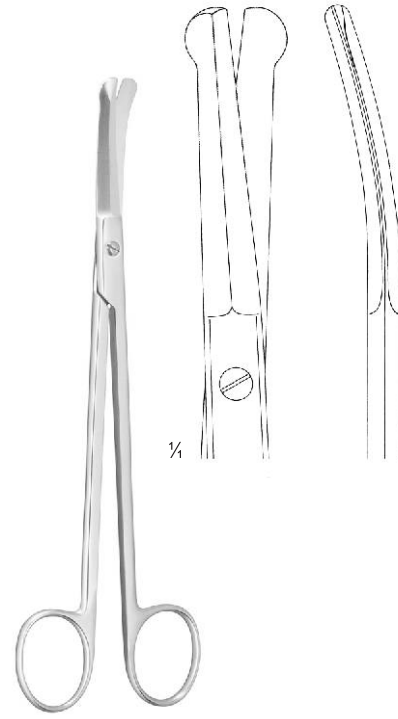

GOOD
BI 04-1391-19
19 cm/7 1/2"

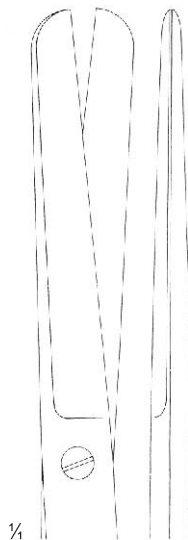
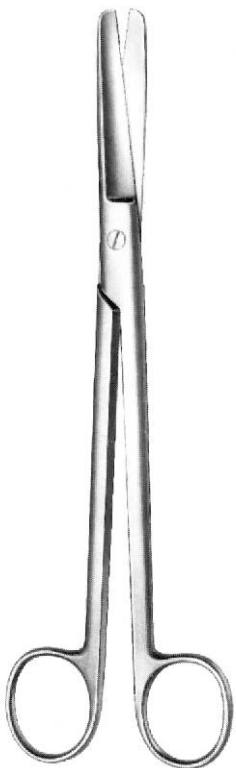

BI 04-1392-20
20 cm/7 7/8"
straight



BI 04-1393-20
20 cm/7 7/8"
curved

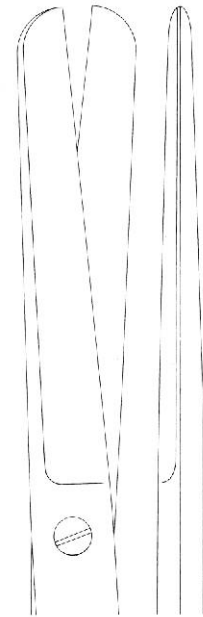

BI 04-1394-23 23 cm/9"
BI 04-1394-25 25 cm/9 7/8"
Straight

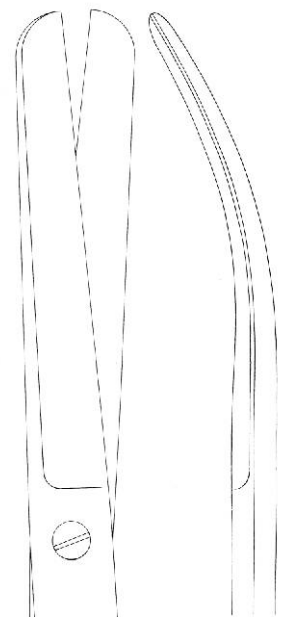

BI 04-1395-23
23 cm/9"
curved

Scissors



SIMS-SIEBOLD
 straight
 BI 04-1396-24
 24 cm/9 1/2"

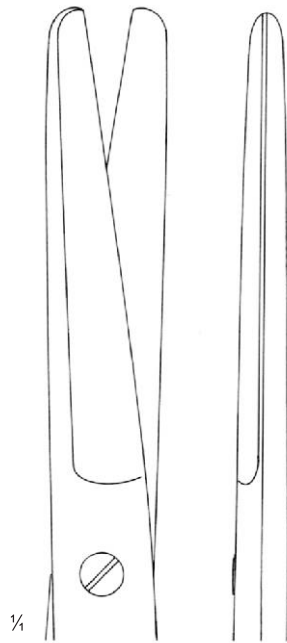

SIMS-SIEBOLD
 S-Shaped
 BI 04-1397-24
 24 cm/9 1/2"

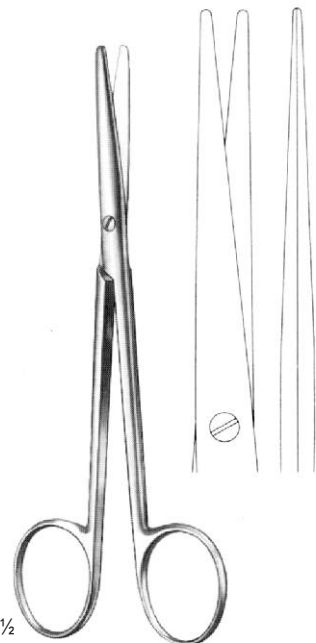
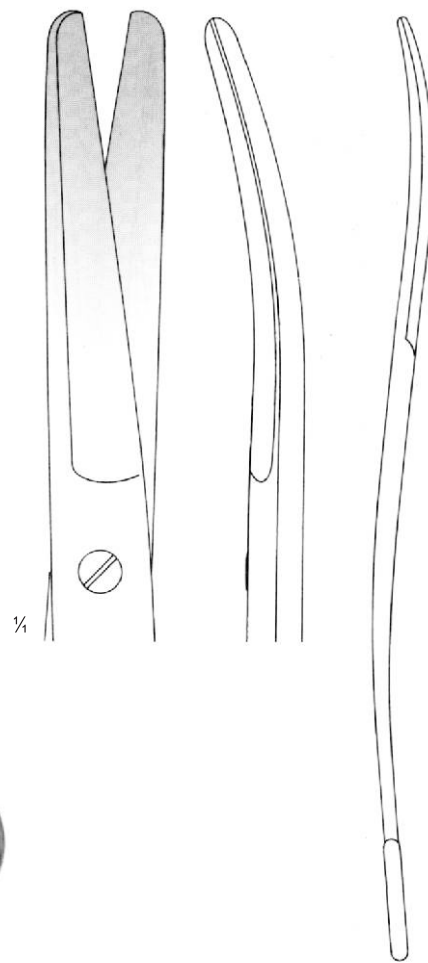

LEXER-FINO
 BI 04-1398-16
 16 cm/6 1/4"
 Straight

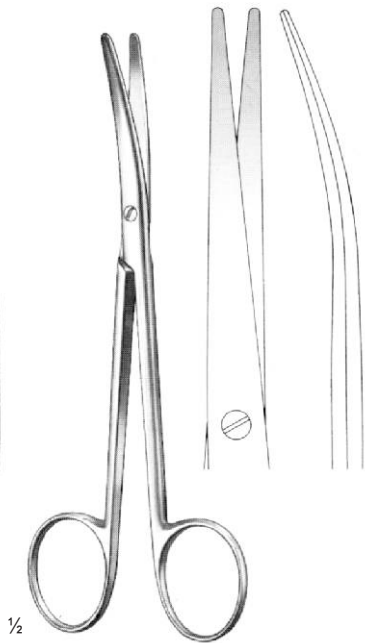

LEXER-FINO
 BI 04-1399-16
 16 cm/6 1/4"
 Curved

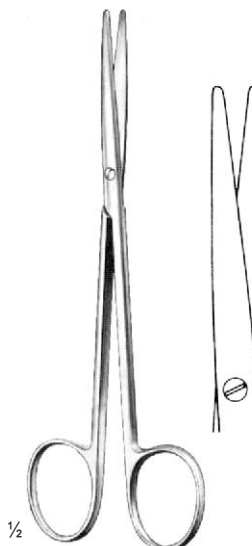

METZENBAUM-FINO
 BI 04-1400-14
 14.5 cm/5 3/4"
 Straight
 Blunt/Blunt

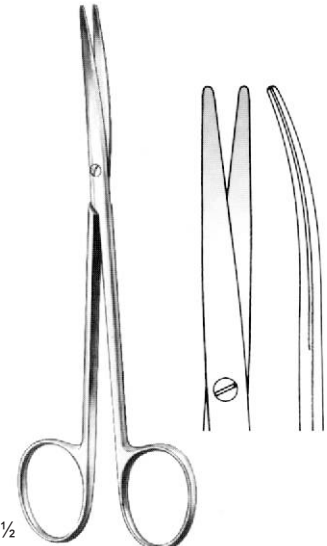

METZENBAUM-FINO
 BI 04-1401-14
 14.5 cm/5 3/4"
 Curved
 Blunt/Blunt



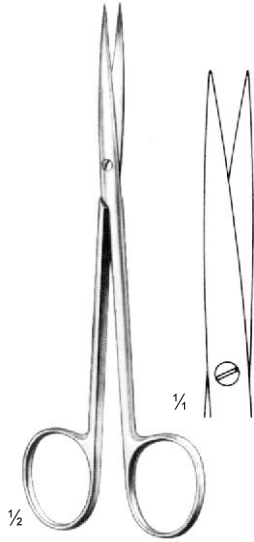

METZENBAUM-FINO
 BI 04-1402-14
 14.5 cm/5 3/4"
 Straight
 Sharp/Sharp

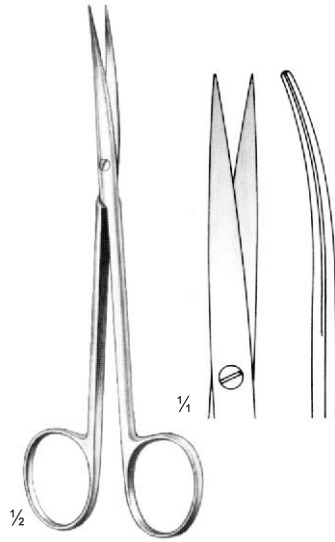

METZENBAUM-FINO
 BI 04-1403-14
 14.5 cm/5 3/4"
 Curved
 Sharp/Sharp

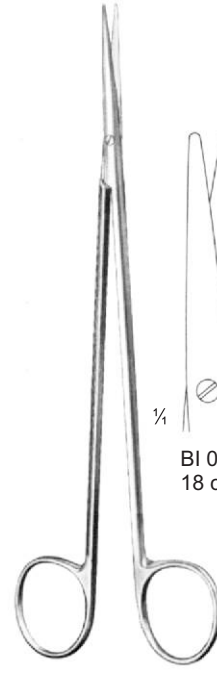

BI 04-1404-18
 18 cm/7 1/8"



BI 04-1404-20
 20 cm/7 7/8"

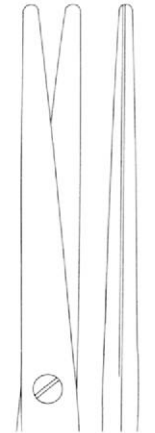

BI 04-1404-23
 23 cm/9"

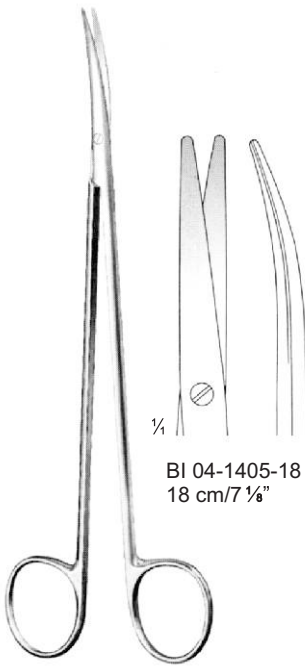

BI 04-1405-18
 18 cm/7 1/8"

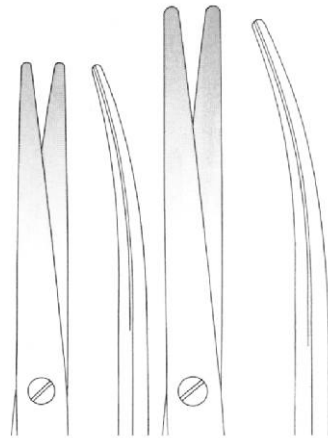

BI 04-1405-20
 20 cm/7 7/8"

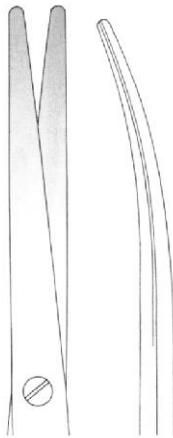

BI 04-1405-23
 23 cm/9"

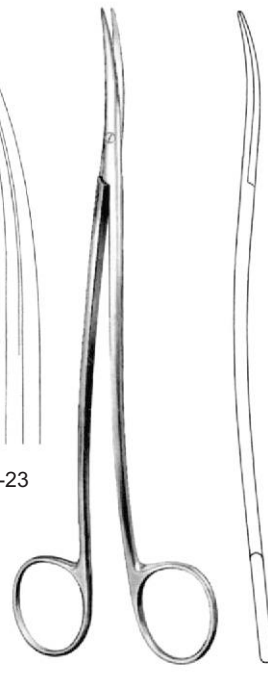

METZENBAUM-FINO
 S-SHAPED



BI 04-1406-18
 18 cm/7 1/8"



BI 04-1406-20
 20 cm/7 7/8"



BI 04-1406-23
 23 cm/9"

Scissors

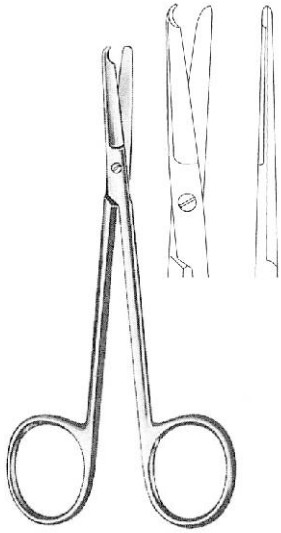

SPENCER
 BI 04-1407-09 9 cm/3 1/2"
 BI 04-1407-10 10.5 cm/4 1/8"
 BI 04-1407-13 13 cm/5 1/8"

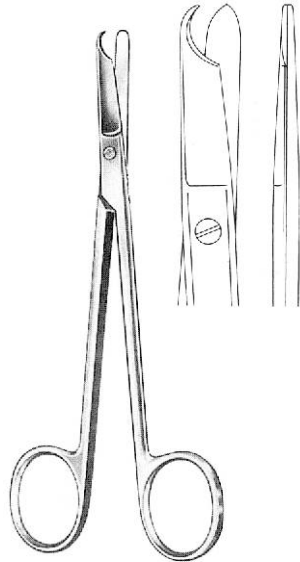

LITTAUER
 BI 04-1408-14
 14 cm/5 1/2"

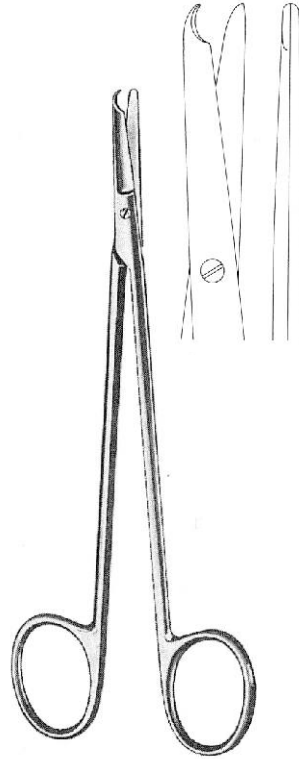

BUCK
 BI 04-1409-14
 14.5 cm/5 3/4"

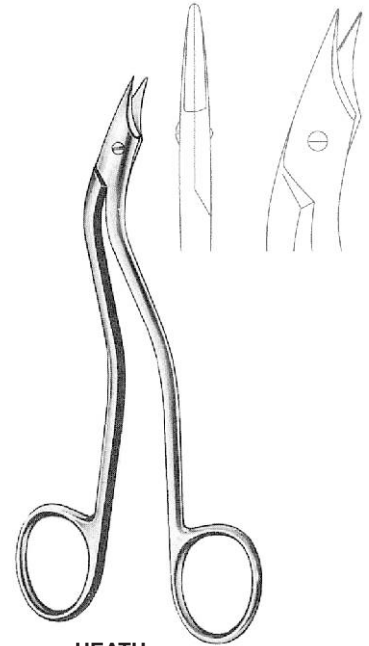

HEATH
 BI 04-1410-15
 15 cm/5 7/8"

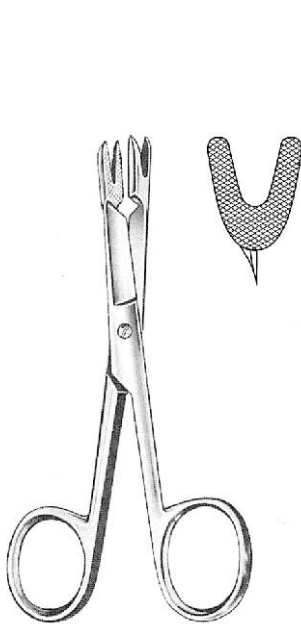

SCHOEMAKER-LOTH
 BI 04-1411-13
 13 cm/5 1/8"

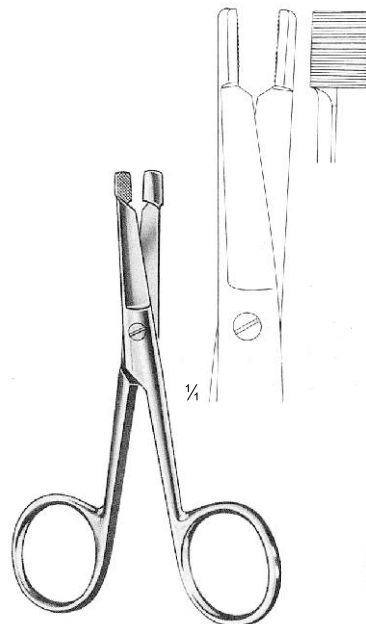

EISELSBERG
 BI 04-1412-12
 12 cm/4 3/4"

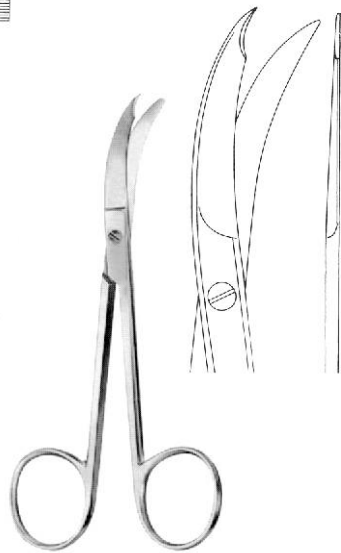

NORTHBENT
 BI 04-1413-09 9 cm/3 1/2"
 BI 04-1413-12 12.5 cm/4 7/8"

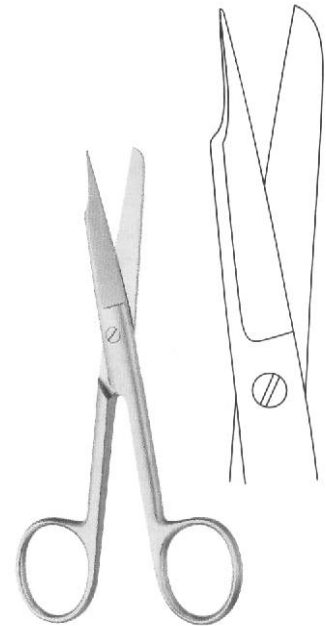

NAIL SPLITTING SCISSORS
 BI 04-1414-13 13 cm/5 1/8"
 BI 04-1414-15 15 cm/5 7/8"



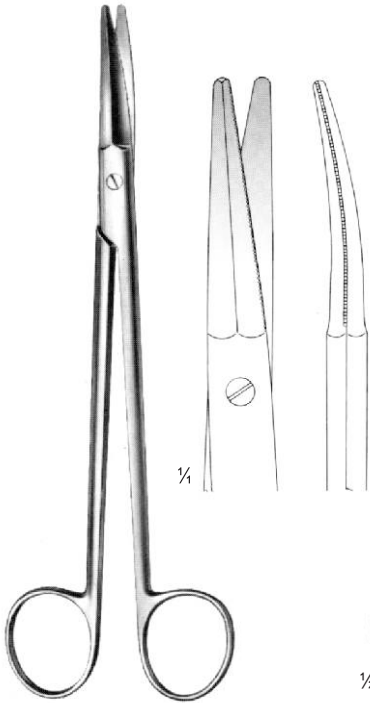

KAYE (TOOTHED)
 BI 04-1415-18
 18.5 cm/7 1/4"

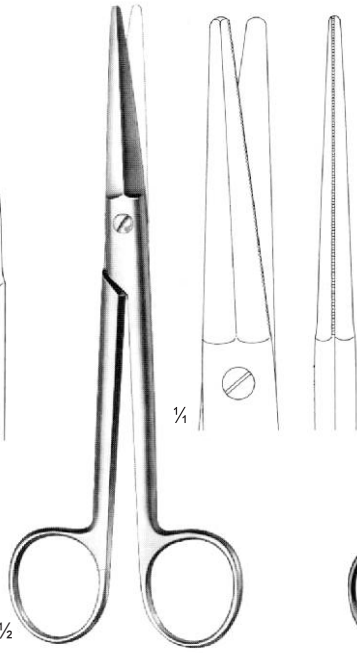

ASTON (TOOTHED)
 BI 04-1416-17
 17 cm/6 3/4"

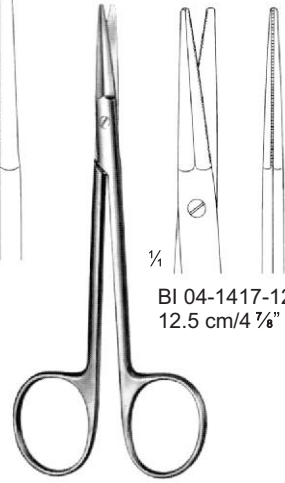

BI 04-1417-12
 12.5 cm/4 7/8"

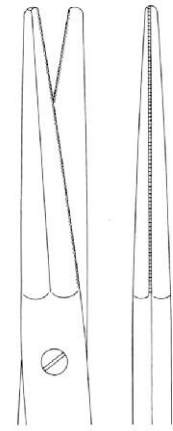

BI 04-1417-19
 19.5 cm/7 1/2"

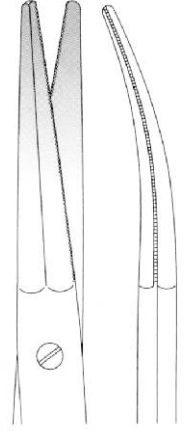

BI 04-1418-19
 19.5 cm/7 1/2"

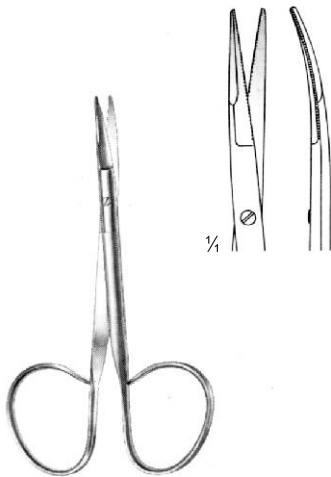

KAYE
 BI 04-1419-11
 11 cm/4 3/8"

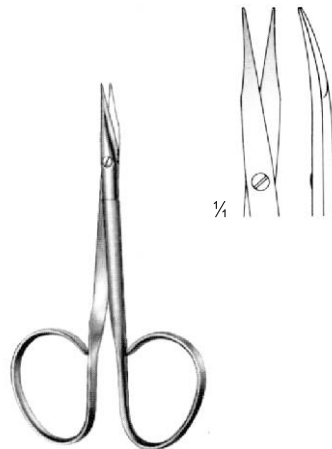

SALYER
 BI 04-1420-10
 10 cm/3 7/8"

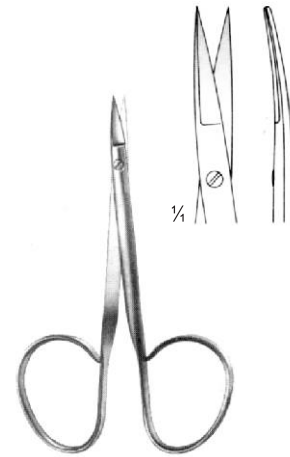

SALYER
 BI 04-1421-09
 9.5 cm/3 3/8"

Scissors

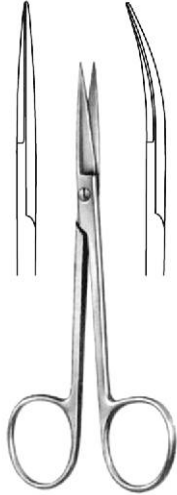

IRIS

	Straight	Curved
9 cm/3 1/2"	BI 04-1422-09	BI 04-1423-09
10.5 cm/4 1/8"	BI 04-1422-10	BI 04-1423-10
11.5 cm/4 1/2"	BI 04-1422-11	BI 04-1423-11

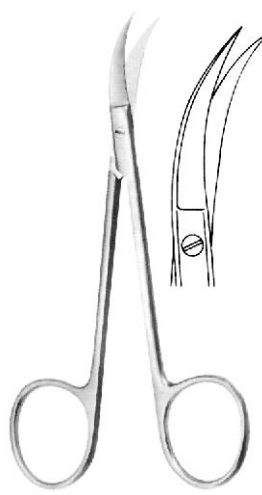

IRIS-FINE

BI 04-1424-11
 11.5 cm/4 1/2"

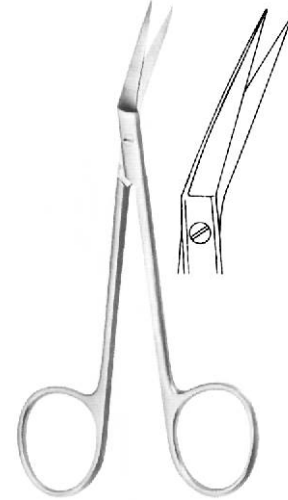

IRIS-FINE

BI 04-1425-11
 11.5 cm/4 1/2"
 angled

Pointed



curved
 BI 04-1427-11

Blunt



straight
 BI 04-1428-11

straight
 BI 04-1426-11

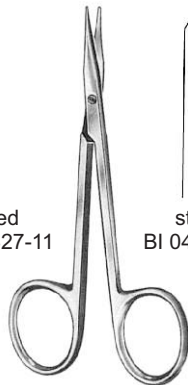

STEVENS-TENOTOMY
 11.5 cm/4 1/2"

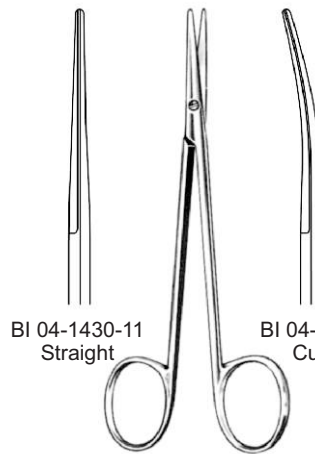

BI 04-1430-11
 Straight

BI 04-1431-11
 Curved

STRABIBIUS
 11.5 cm/4 1/2"

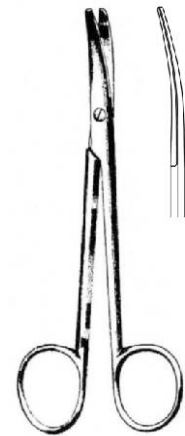

ENUCLEATION
 BI 04-1432-11
 11 cm/4 3/8"



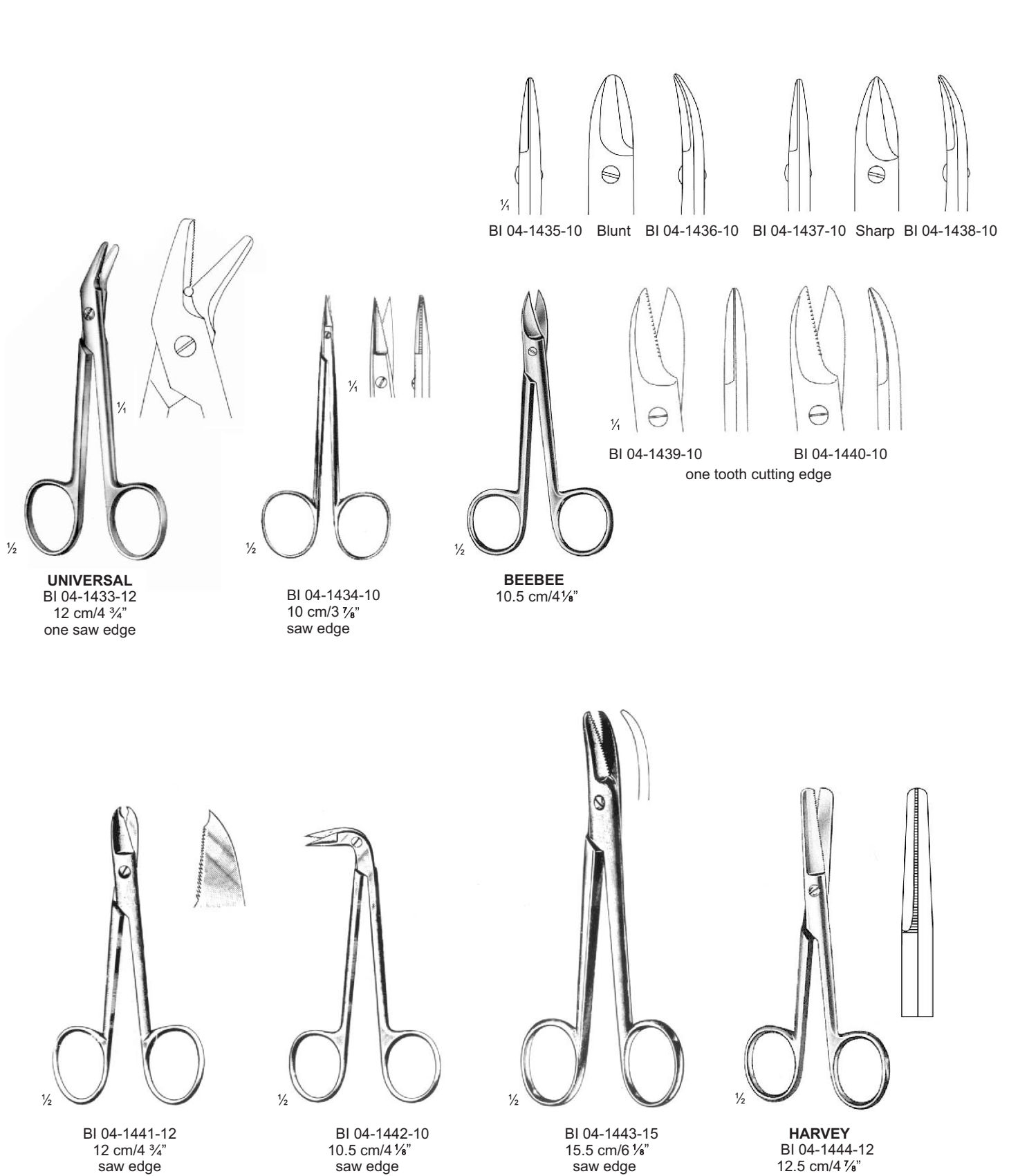

Scissors

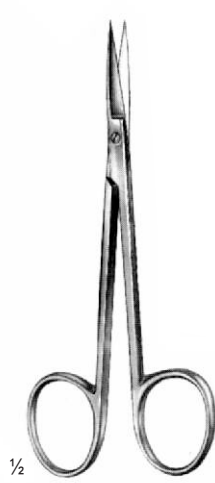

12 cm/4 3/4"



BI 04-1445-12
 Straight
 Sharp/Blunt



BI 04-1446-12
 Straight
 Sharp/Sharp

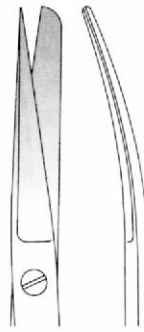

BI 04-1447-12
 Curved
 Sharp/Blunt



BI 04-1448-12
 Curved
 Sharp/Sharp

Fine Scissors

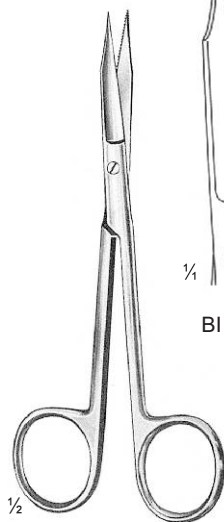

GOLDMANN-FOX
 13 cm/5 1/4"



BI 04-1449-13
 Straight

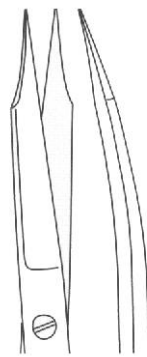

BI 04-1450-13
 Curved

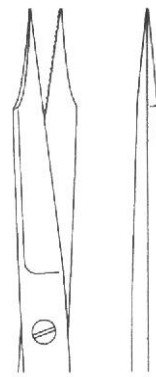

BI 04-1451-13
 Straight



BI 04-1452-13
 Curved

Toothed Blades



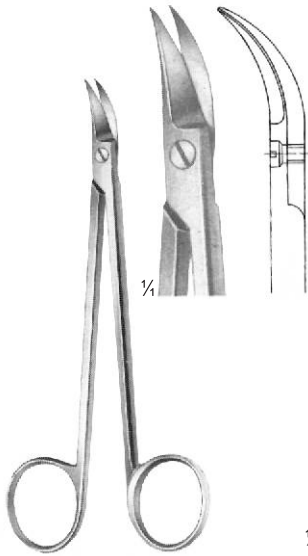

QUINBY
BI 04-1453-12
12.5 cm/4 7/8"

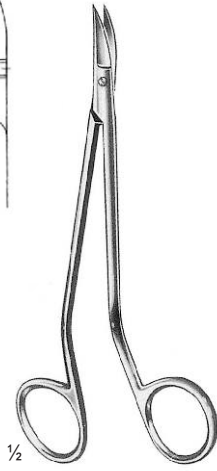

NEUMANN
BI 04-1454-12
12 cm/4 3/4"

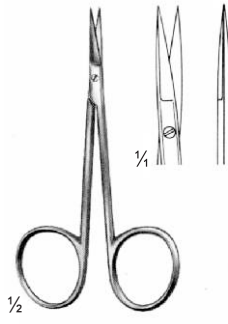

BI 04-1455-08
8 cm/3 1/4"
delicate

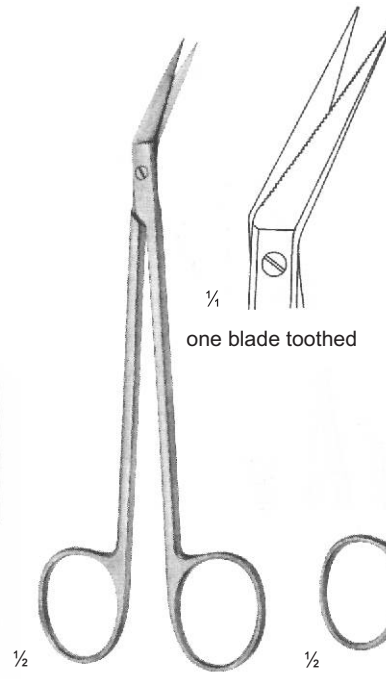

LOCKLIN
BI 04-1456-16
16 cm/6 1/4"

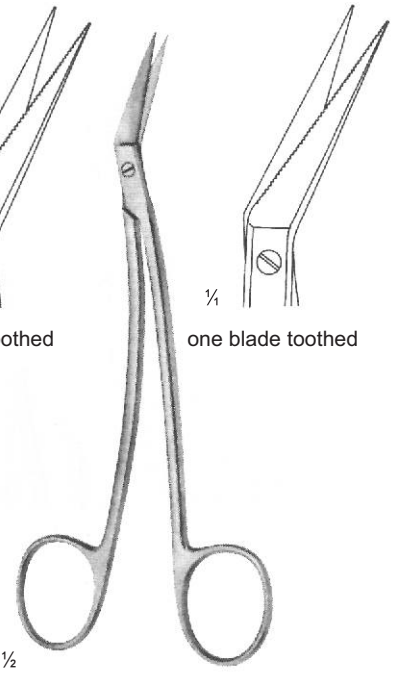

LOCKLIN
BI 04-1457-16
16 cm/6 1/4"

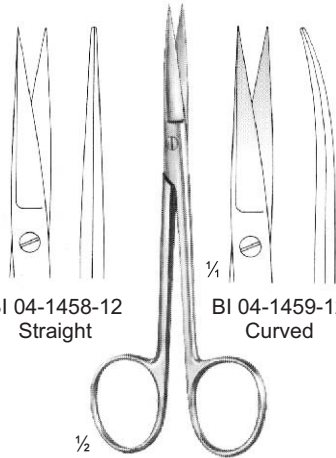

BI 04-1458-12
Straight

WAGNER
12 cm/4 3/4"

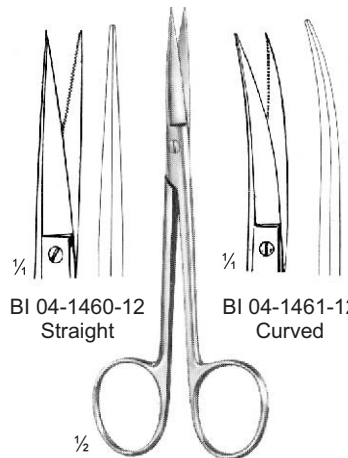

BI 04-1459-12
Curved

WAGNER
12 cm/4 3/4"
Saw edge

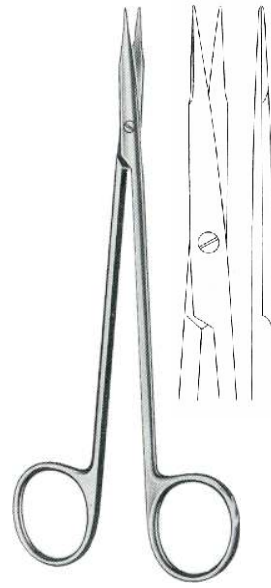

REYNOLDS
Straight
BI 04-1462-14 14.5 cm/5 3/4"
BI 04-1462-15 15.5 cm/6 1/8"
BI 04-1462-17 17.5 cm/6 7/8"
BI 04-1462-18 18.0 cm/7 1/8"



Curved
BI 04-1463-14
BI 04-1463-15
BI 04-1463-17
BI 04-1463-18

Scissors



SCHUMACHER
 BI 04-1464-16
 16 cm/6 1/4"

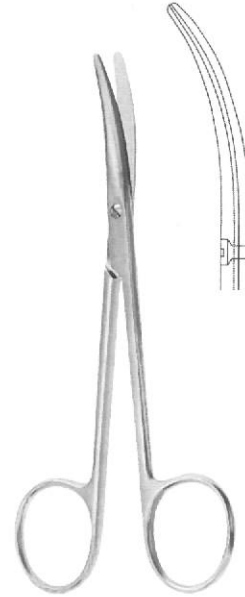

LANDOLT
 BI 04-1465-12
 12.5 cm/4 7/8"

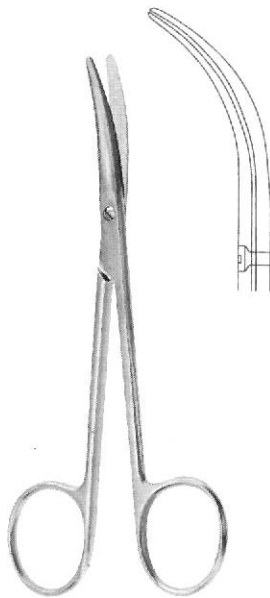

LANDOLT
 BI 04-1466-12
 12.5 cm/4 7/8"

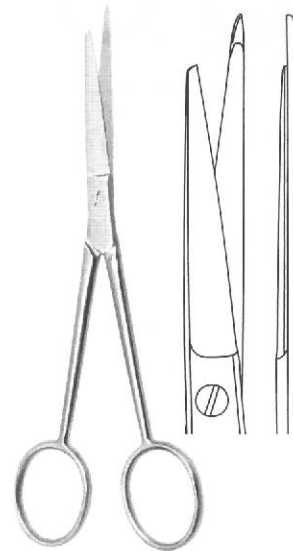

BI 04-1467-14
 14.5 cm/5 3/4"



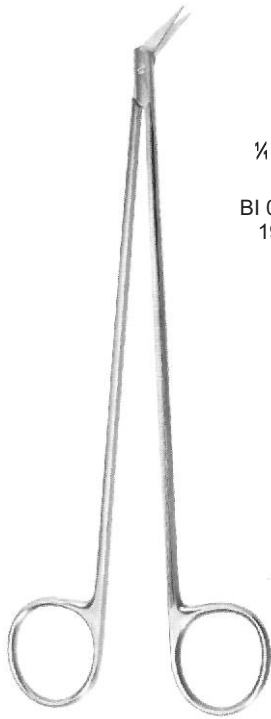

DIETRICH



25°
BI 04-1468-19
19 cm/7 1/2"



45°
BI 04-1468-18
18 cm/7 1/8"



60°
BI 04-1468-17
17.5 cm/6 7/8"



90°
BI 04-1469-17
17.5 cm/6 7/8"



125°
BI 04-1470-17
17.5 cm/6 7/8"

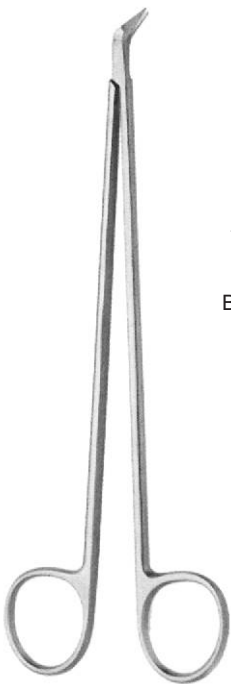

MICRO-HEGEMANN
19 cm/7 1/2"



25°
BI 04-1471-19



45°
BI 04-1472-19



60°
BI 04-1473-19



90°
BI 04-1474-19

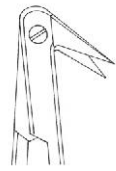

125°
BI 04-1475-19

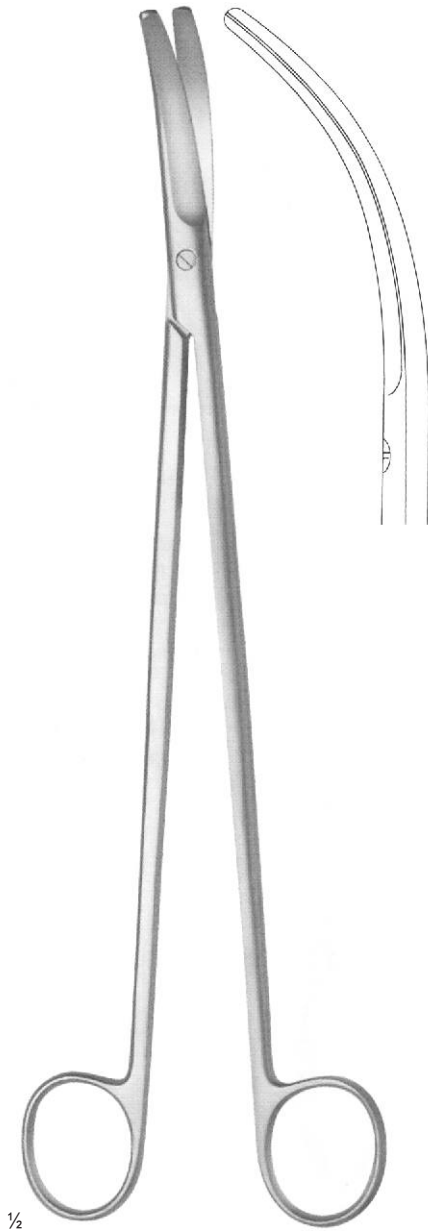

RECTAL
 BI 04-1476-32
 32.5 cm/12 3/4"

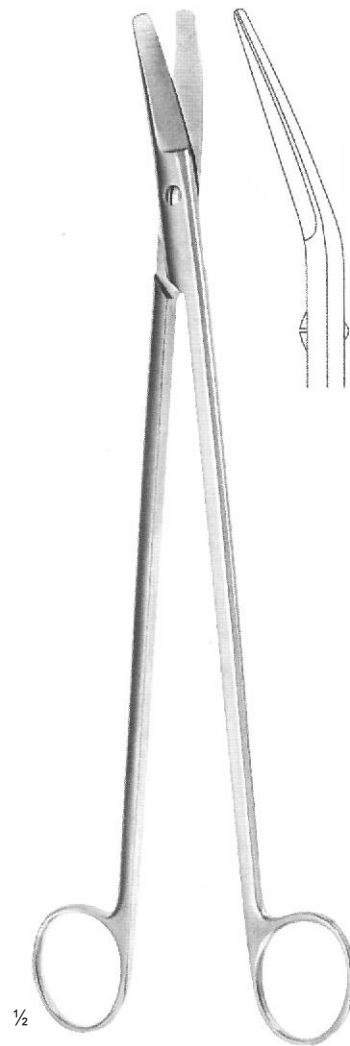

FINOCHIETTO
 BI 04-1477-27
 27 cm/10 1/2"



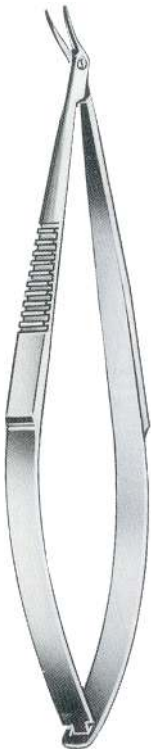

TROUTMAN
BI 04-1478-10
10 cm/4"



TROUTMAN
BI 04-1479-10
10 cm/4"

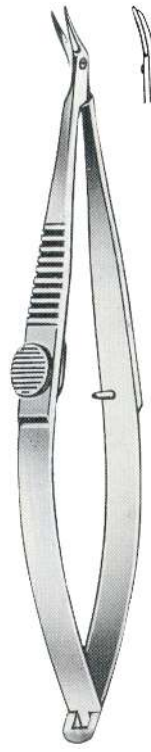

KATZIN-BARRAQUER
BI 04-1480-10
10 cm/4"



KATZIN-BARRAQUER
BI 04-1481-10
10 cm/4"



KATZIN
BI 04-1482-10
10 cm/4"



KATZIN
BI 04-1483-10
10 cm/4"



WESTCOTT
BI 04-1484-11
11 cm/4½"



WESTCOTT
BI 04-1485-11
11 cm/4½"



WESTCOTT
BI 04-1486-11
11 cm/4½"



BI 04-1487-10
 10 cm/4"



BI 04-1488-10
 10 cm/4"



Micro Scissors
CASTROVIEJO
 BI 04-1489-10
 10 cm/4"



CASTROVIEJO
 BI 04-1490-10
 10 cm/4"



AEBLI
 BI 04-1491-10
 10 cm/4"



CASTROVIEJO
 BI 04-1492-10
 10 cm/4"



CASTROVIEJO
 BI 04-1493-10
 10 cm/4"

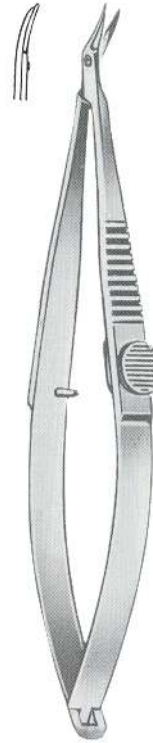

TROUTMAN-BARRAQUER
 BI 04-1494-10
 10 cm/4"

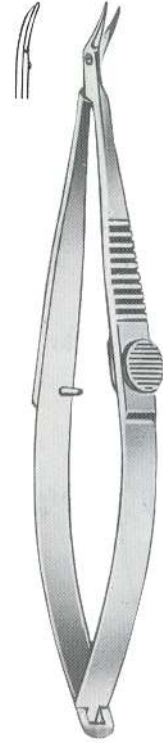

TROUTMAN-BARRAQUER
 BI 04-1495-10
 10 cm/4"



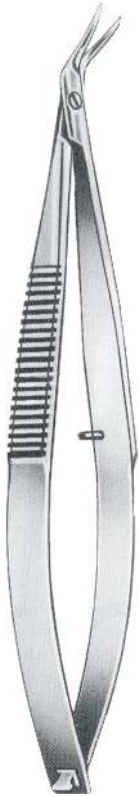

CASTROVIEJO
BI 04-1496-10
10 cm/4"

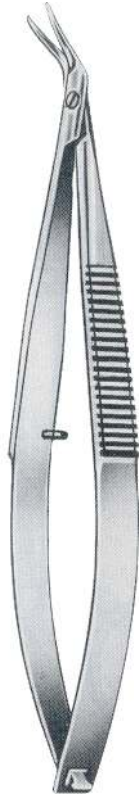

CASTROVIEJO
BI 04-1497-10
10 cm/4"



CASTROVIEJO
BI 04-1498-11
11.5 cm/4½"



CASTROVIEJO
BI 04-1499-11
11.5 cm/4½"

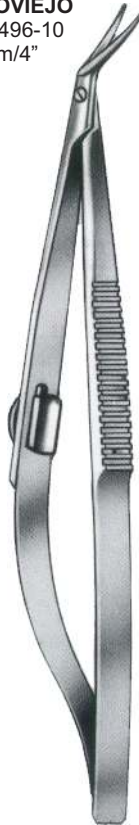

TROUTMANN-CASTROVIEJO
BI 04-1500-10
10.5 cm/4¼"



TROUTMANN-CASTROVIEJO
BI 04-1501-10
10.5 cm/4¼"



14.5 cm/5¾"
18.0 cm/7"

Straight
BI 04-1502-14
BI 04-1502-18

Curved
BI 04-1503-14
BI 04-1503-18

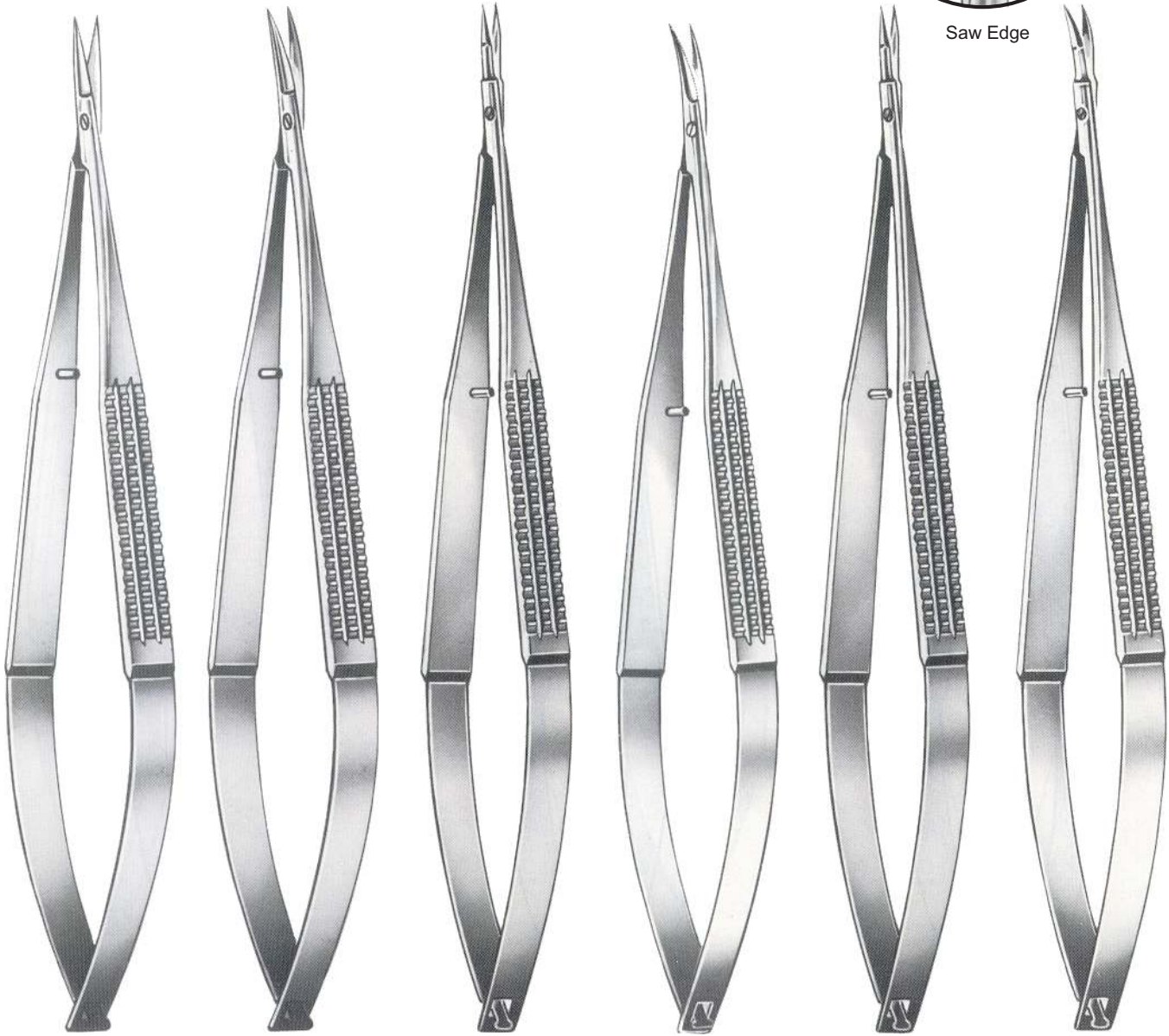

Straight
 BI 04-1504-16
 16cm/6¼"

Curved
 BI 04-1505-16
 16cm/6¼"

Straight
 BI 04-1506-16
 16cm/6¼"

Curved
 BI 04-1507-16
 16cm/6¼"

MILLESI
 Straight
 BI 04-1508-16
 16cm/6¼"

MILLESI
 Curved
 BI 04-1509-16
 16cm/6¼"



Straight
BI 04-1510-14
14.5cm/5¾"



Curved
BI 04-1511-14
14.5cm/5¾"

Dissecting Scissors



Curved
BI 04-1512-14
14.5cm/5¾"